

General Description

The DS1088L is a low-cost clock generator that produces a square-wave output without external timing components. The fixed-frequency oscillator is available in factory-calibrated frequencies from 312kHz to 133MHz. The device has a power-down pin for power-sensitive applications.

Applications

- Printers
- Copiers
- Computer Peripherals
- POS Terminals
- Cable Modems

Ordering Information appears at end of data sheet.

Features

- Factory-Programmed Square-Wave Generator from 321kHz to 133MHz
- Single Output
- No External Timing Components Required
- 2.7V to 3.6V Supply
- Power-Down Mode
- 1% Frequency Tolerance Over Temperature and Voltage
- Wide Temperature Range (-20°C to +85°C)

Typical Operating Circuit

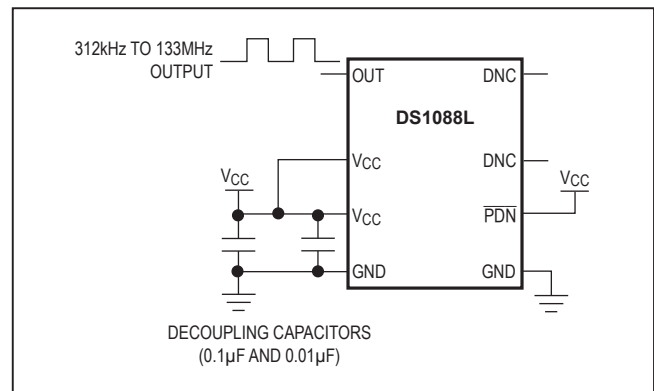

EconOscillator is a trademark of Maxim Integrated Products, Inc.

For related parts and recommended products to use with this part, refer to www.maximintegrated.com/DS1088L.related.

Absolute Maximum Ratings

(Voltages relative to ground.)

Voltage Range on V_{CC}-0.5V to +6.0V
 Voltage Range on \overline{PDN}-0.5V to ($V_{CC} + 0.5V$)*
 Operating Temperature Range..... -20°C to +85°C

Storage Temperature Range..... -55°C to +125°C
 Lead Temperature (soldering, 10s) +300°C
 Soldering Temperature (reflow) +260°C

*Not to exceed +6.0V.

Stresses beyond those listed under "Absolute Maximum Ratings" may cause permanent damage to the device. These are stress ratings only, and functional operation of the device at these or any other conditions beyond those indicated in the operational sections of the specifications is not implied. Exposure to absolute maximum rating conditions for extended periods may affect device reliability.

Recommended Operating Conditions

($T_A = -20^\circ\text{C}$ to $+85^\circ\text{C}$, unless otherwise noted.)

PARAMETER	SYMBOL	CONDITIONS	MIN	TYP	MAX	UNITS
Supply Voltage	V_{CC}	(Note 1)	2.7		3.6	V
High-Level Input Voltage (\overline{PDN})	V_{IH}		$0.7 \times V_{CC}$		$V_{CC} + 0.3$	V
Low-Level Input Voltage (\overline{PDN})	V_{IL}		-0.3		$0.3 \times V_{CC}$	V

DC Electrical Characteristics

($V_{CC} = 2.7V$ to $3.6V$, $T_A = -20^\circ\text{C}$ to $+85^\circ\text{C}$, unless otherwise noted.)

PARAMETER	SYMBOL	CONDITIONS	MIN	TYP	MAX	UNITS
High-Level Output Voltage (OUT)	V_{OH}	$I_{OH} = -4\text{mA}$, $V_{CC} = \text{MIN}$	$V_{CC} - 0.4$			V
Low-Level Output Voltage (OUT)	V_{OL}	$I_{OL} = 4\text{mA}$			0.4	V
High-Level Input Current (\overline{PDN})	I_{IH}	$V_{CC} = 3.6V$			1	μA
Low-Level Input Current (\overline{PDN})	I_{IL}	$V_{IL} = 0V$	-1			μA
Supply Current (Active)	I_{CC}	$V_{CC} = 3.6V$, $C_L = 15\text{pF}$, $f_O = 133\text{MHz}$		15	24	mA
Standby Current (Power-Down)	I_{CCQ}	Power-down mode			10	μA

Oscillator Characteristics

($V_{CC} = 2.7V$ to $3.6V$, $T_A = -20^\circ C$ to $+85^\circ C$, unless otherwise noted.)

PARAMETER	SYMBOL	CONDITIONS	MIN	TYP	MAX	UNITS
Output Frequency Range Available	f_O		0.3124		133.3	MHz
Output Frequency Tolerance	$\frac{\Delta f_O}{f_O}$	$V_{CC} = 3.3V$, $T_A = +25^\circ C$ (Note 2)	-0.3		+0.3	%
Voltage Frequency Variation	$\frac{\Delta f_V}{f_O}$	Over voltage range, $T_A = +25^\circ C$ (Note 3)	-0.35		+0.35	%
Temperature Frequency Variation	$\frac{\Delta f_T}{f_O}$	Over temperature range, $V_{CC} = 3.3V$ (Notes 4, 5)	-20°C to +25°C	-0.7	+0.7	%
		+25°C to +85°C	-0.5	+0.5		
Frequency Variation Over Voltage and Temperature	$\frac{\Delta f_{V,T}}{f_O}$	Over voltage and temperature range	-1.0		+1.0	%

AC Electrical Characteristics

($V_{CC} = 2.7V$ to $3.6V$, $T_A = -20^\circ C$ to $+85^\circ C$, unless otherwise noted.)

PARAMETER	SYMBOL	CONDITIONS	MIN	TYP	MAX	UNITS
Power-Up Time	$t_{POR} + t_{STAB}$	(Note 6)			100	μs
OUT Disabled After Entering Power-Down Mode	t_{PDN}	(Note 7)			7	μs
Load Capacitance	C_L	(Note 8)		15	50	pF
Output Duty Cycle (OUT)		$f_O < 80MHz$, $f_O \geq 80MHz$	40		60	%
		$f_O < 80MHz$		50		

Note 1: All voltages are referenced to ground.

Note 2: Typical frequency shift due to aging is within $\pm 0.2\%$. Aging stressing includes level 1 moisture reflow preconditioning (24hr $+125^\circ C$ bake, 168hr $+85^\circ C/85\%RH$ moisture soak, and three solder reflow passes $+240^\circ C +0^\circ C/-5^\circ C$ peak) followed by 1000hr (max) V_{CC} biased $+125^\circ C$ OP/L, 1000hr unbiased $+150^\circ C$ bake, 1000 temperature cycles at $-55^\circ C$ to $+125^\circ C$, and 168hr $+121^\circ C/2$ ATM steam/unbiased autoclave.

Note 3: This is the change in output frequency due to changes in voltage at $T_A = +25^\circ C$.

Note 4: Guaranteed by design.

Note 5: This is the change in output frequency due to changes in temperature from the $+25^\circ C$ frequency at $V_{CC} = 3.3V$.

Note 6: This indicates the time elapsed between power-up and the output becoming active. An on-chip delay is intentionally introduced to allow the oscillator to stabilize. t_{STAB} is equivalent to approximately 512 clock cycles and will depend on the programmed oscillator frequency.

Note 7: Output disabled in two cycles or less of the output frequency.

Note 8: Output voltage swings may be impaired at high frequencies combined with high-output loading.

Typical Operating Characteristics

($V_{CC} = 3.3V$, $T_A = +25^\circ C$, unless otherwise noted.)

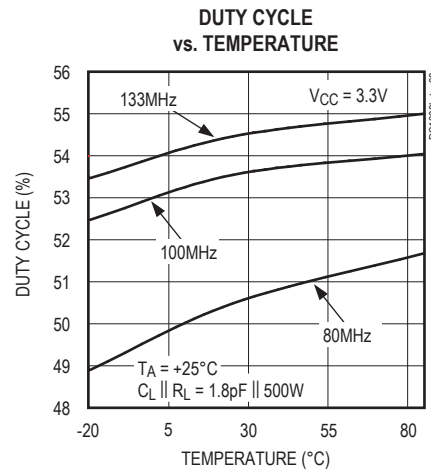
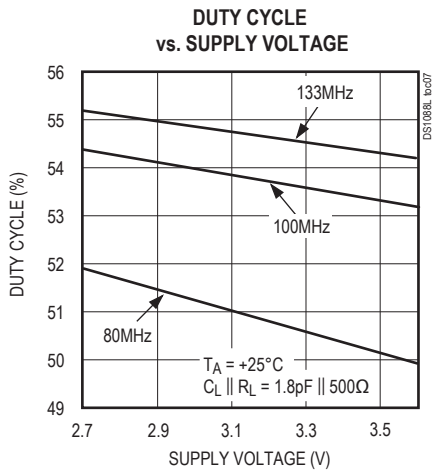
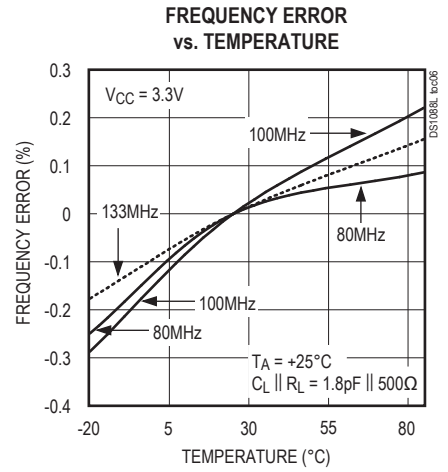
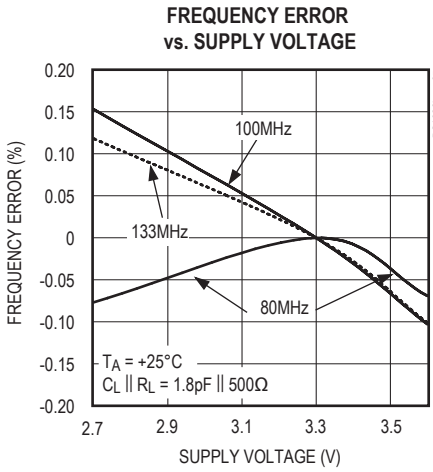
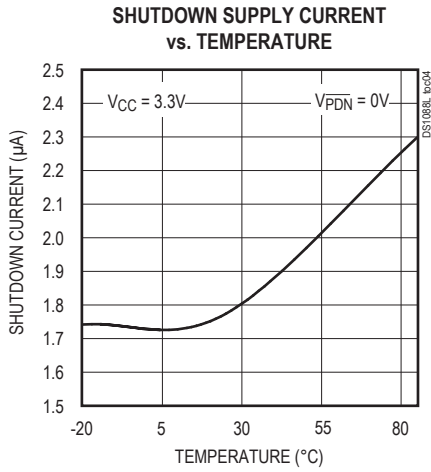
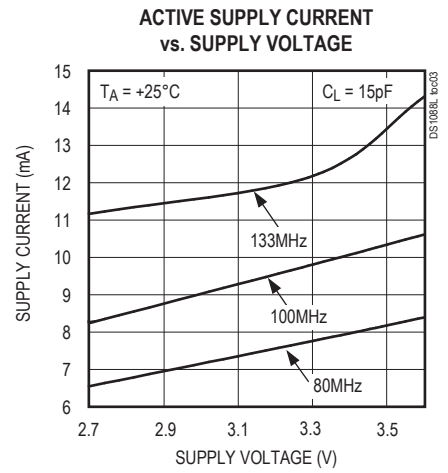
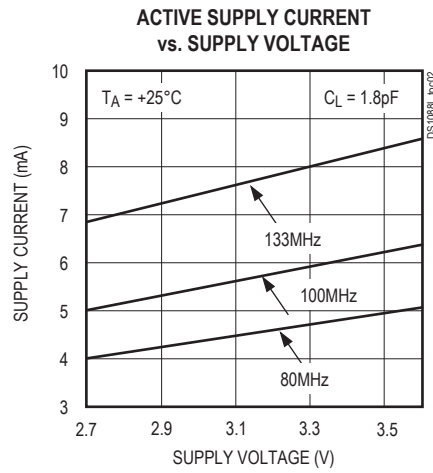
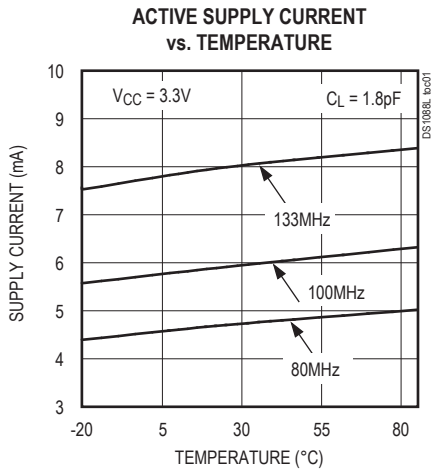

Pin Configuration

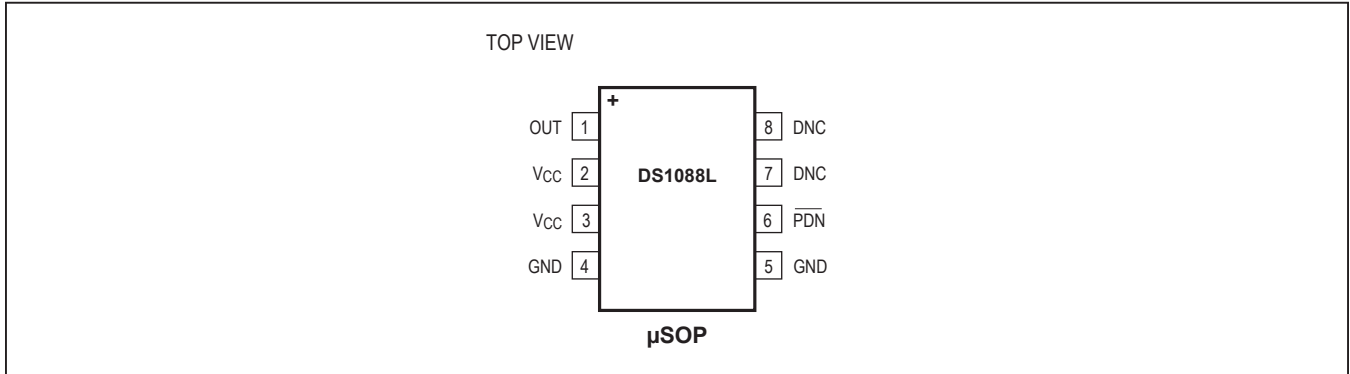

Pin Description

PIN	NAME	FUNCTION
1	OUT	Oscillator Output
2, 3	V _{CC}	Power Supply
4, 5	GND	Ground
6	$\overline{\text{PDN}}$	Active-Low Power-Down. When the pin is high, the oscillator is enabled. When the pin is low, the oscillator is disabled (power-down mode).
7	DNC	Do Not Connect. The DNC pins are internally connected to ground.
8	DNC	Do Not Connect

Detailed Description

The DS1088L is a low-cost clock generator that produces a square-wave output without external timing components. The fixed-frequency oscillator is available in factory-calibrated frequencies from 312kHz to 133MHz. The device has a power-down pin for power-sensitive applications. A block diagram is shown in [Figure 1](#).

Output Frequency

The internal oscillator frequency is divided by the factory-programmed prescaler to produce an output frequency of 312kHz to 133MHz. Contact the factory for custom frequencies.

Power-Down Mode

The $\overline{\text{PDN}}$ pin disables the internal oscillator and the oscillator output for power-sensitive applications. The power-down pin must remain low for at least two output frequency cycles plus 10 μs for deglitching purposes. On power-up, the output is disabled until power is stable and the voltage-controlled oscillator has generated 512 clock cycles.

Applications Information

Power-Supply Decoupling

To achieve the best results when using the DS1088L, the power supply must be decoupled with 0.01 μF and 0.1 μF high-quality, ceramic, surface-mount capacitors. Surface-mount components minimize lead inductance, which improves performance, and tend to have adequate high-frequency response for decoupling applications. These capacitors should be placed as close as possible to the VCC and GND pins.

Chip Information

SUBSTRATE CONNECTED TO GROUND

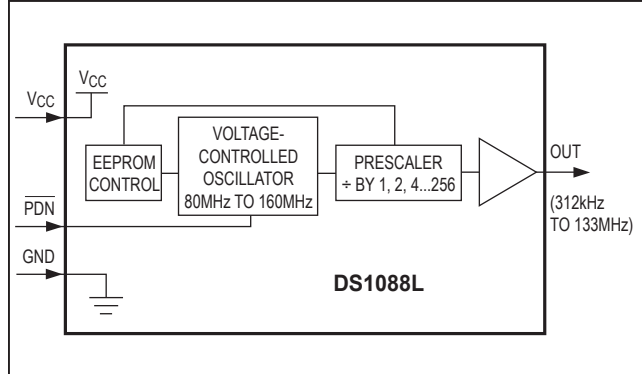

Figure 1. Block Diagram

Ordering Information

PART	FREQUENCY (MHz)	TEMP RANGE	PIN-PACKAGE
DS1088LU-02+	2.048	-20°C to +85°C	8 μ SOP
DS1088LU-10+	10.0	-20°C to +85°C	8 μ SOP
DS1088LU-16+	16.6	-20°C to +85°C	8 μ SOP
DS1088LU-66+	66.6	-20°C to +85°C	8 μ SOP
DS1088LU-100+	100.0	-20°C to +85°C	8 μ SOP
DS1088LU-yyy+	(see note)	-20°C to +85°C	8 μ SOP

Note: For more information about custom frequencies, email Custom_EconOscillators_Info@maximintegrated.com.

+Denotes a lead(Pb)-free/RoHS-compliant package.

yyy = frequency

Package Information

For the latest package outline information and land patterns (footprints), go to www.maximintegrated.com/packages. Note that a "+", "#", or "-" in the package code indicates RoHS status only. Package drawings may show a different suffix character, but the drawing pertains to the package regardless of RoHS status.

PACKAGE TYPE	PACKAGE CODE	OUTLINE NO.	LAND PATTERN NO.
8 μ SOP	U8+1	21-0036	90-0092

Revision History

REVISION NUMBER	REVISION DATE	DESCRIPTION	PAGES CHANGED
0	10/04	Initial release	—
1	5/05	Updated the <i>Oscillator Characteristics</i> table and added Note 8	3
2	1/12	Added lead(Pb)-free ordering option to the <i>Ordering Information</i> table; added the lead and soldering temperature information to the <i>Absolute Maximum Ratings</i> section	1, 2
3	4/15	Removed automotive reference from data sheet	1

For pricing, delivery, and ordering information, please contact Maxim Direct at 1-888-629-4642, or visit Maxim Integrated's website at www.maximintegrated.com.

Maxim Integrated cannot assume responsibility for use of any circuitry other than circuitry entirely embodied in a Maxim Integrated product. No circuit patent licenses are implied. Maxim Integrated reserves the right to change the circuitry and specifications without notice at any time. The parametric values (min and max limits) shown in the *Electrical Characteristics* table are guaranteed. Other parametric values quoted in this data sheet are provided for guidance.