

Product Summary (Typ. @ $V_{GS} = 3.3V$, $T_A = +25^\circ C$)

V_{DSS}	$R_{DS(ON)}$	Q_g	Q_{gd}	I_D
12V	14.1m Ω	10.5nC	4.1nC	7.5A

Description

This new generation MOSFET is engineered to minimize on-state losses and switch ultra-fast, making it ideal for high efficiency power transfer. Using Chip-Scale Package (CSP) to increase power density by combining low thermal impedance with minimal $R_{DS(ON)}$ per footprint area.

Applications

- DC-DC Converters
- Battery Management
- Load Switch

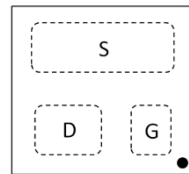

Top-View
Pin Configuration

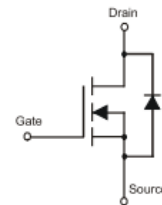

Equivalent Circuit

Features

- TR-MOS Technology with the Lowest $R_{DS(ON)}$:
 $R_{DS(ON)} = 14.1m\Omega$ to Minimize On-State Losses
- CSP with Footprint 1.0mm x 1.0mm
- Height = 0.29mm for Low Profile
- **Totally Lead-Free & Fully RoHS Compliant (Notes 1 & 2)**
- **Halogen and Antimony Free. "Green" Device (Note 3)**
- **For automotive applications requiring specific change control (i.e. parts qualified to AEC-Q100/101/200, PPAP capable, and manufactured in IATF 16949 certified facilities), please [contact us](mailto:contact@diodes.com) or your local Diodes representative.**
<https://www.diodes.com/quality/product-definitions/>

Mechanical Data

- Case: X3-DSN1010-3
- Moisture Sensitivity: Level 1 per J-STD-020
- Terminal Connections: See Diagram Below
- Terminal Finish: Matte Tin Annealed Over Copper Pillar (E3)
- Solder Cap Material: SnAg (Ag: 2.0+/-0.5%)
- Weight: 0.00062 grams (Approximate)

Ordering Information (Note 4)

Part Number	Case	Packaging
DMN1017UCP3-7	X3-DSN1010-3	3000/Tape & Reel

- Notes:
1. No purposely added lead. Fully EU Directive 2002/95/EC (RoHS), 2011/65/EU (RoHS 2) & 2015/863/EU (RoHS 3) compliant.
 2. See <https://www.diodes.com/quality/lead-free/> for more information about Diodes Incorporated's definitions of Halogen- and Antimony-free, "Green" and Lead-free.
 3. Halogen- and Antimony-free "Green" products are defined as those which contain <900ppm bromine, <900ppm chlorine (<1500ppm total Br + Cl) and <1000ppm antimony compounds.
 4. For packaging details, go to our website at <https://www.diodes.com/design/support/packaging/diodes-packaging/>.

Marking Information (Note 5)

Marking 1

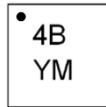

4B = Product Type Marking Code
 YM = Date Code Marking
 Y or \bar{Y} = Year (ex: 1 = 2021)
 M or \bar{M} = Month (ex: 9 = September)

Date Code Key

Year	2017	...	2021	2022	2023	2024	2025	2026	2027	2028	2029	2030
Code	E	...	I	J	K	L	M	N	O	P	R	S
Month	Jan	Feb	Mar	Apr	May	Jun	Jul	Aug	Sep	Oct	Nov	Dec
Code	1	2	3	4	5	6	7	8	9	O	N	D

Marking 2

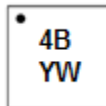

4B = Product Type Marking Code
 YW = Date Code Marking
 Y or \bar{Y} = Year (ex: 1 = 2021)
 W or \bar{W} = Week (ex: a = Week 27; z Represents Week 52 and 53)

Date Code Key

Year	2017	...	2021	2022	2023	2024	2025	2026	2027	2028	2029	2030
Code	7	...	1	2	3	4	5	6	7	8	9	0
Week	1-26			27-52				53				
Code	A-Z			a-z				z				

Note: 5. The marking code changed to Marking 2 from week 6, 2021.

Maximum Ratings

Characteristic	Symbol	Value	Unit	
Drain-Source Voltage	V_{DS}	12	V	
Gate-Source Voltage	V_{GS}	± 8	V	
Continuous Drain Current @ $V_{GS} = 3.3V$ (Note 6)	I_D	$T_A = +25^\circ C$	5.4	A
		$T_A = +70^\circ C$	4.3	A
Continuous Drain Current @ $V_{GS} = 3.3V$ (Note 7)	I_D	$T_A = +25^\circ C$	7.5	A
		$T_A = +70^\circ C$	6.1	A
Pulsed Drain Current (Pulse Duration 10 μs , Duty Cycle $\leq 1\%$)	I_{DM}	15	A	
Continuous Source-Drain Diode Current (Note 7)	I_S	1.47	A	
Pulse Diode Forward Current (Note 7)	I_{SM}	15	A	

Thermal Characteristics

Characteristic	Symbol	Value	Unit
Total Power Dissipation (Note 6)	P_D	0.74	W
Thermal Resistance, Junction to Ambient (Note 6)	$R_{\theta JA}$	167	$^\circ C/W$
Total Power Dissipation (Note 7)	P_D	1.47	W
Thermal Resistance, Junction to Ambient (Note 7)	$R_{\theta JA}$	85	$^\circ C/W$
Operating and Storage Temperature Range	T_J, T_{STG}	-55 to +150	$^\circ C$

Electrical Characteristics (@ $T_A = +25^\circ C$, unless otherwise specified.)

Characteristic	Symbol	Min	Typ	Max	Unit	Test Condition
OFF CHARACTERISTICS (Note 8)						
Drain-Source Breakdown Voltage	BV_{DSS}	12	—	—	V	$V_{GS} = 0V, I_D = 250\mu A$
Zero Gate Voltage Drain Current	I_{DSS}	—	—	1.0	μA	$V_{DS} = 9.6V, V_{GS} = 0V$
Gate-Body Leakage	I_{GSS}	—	—	± 100	nA	$V_{GS} = \pm 8V, V_{DS} = 0V$
ON CHARACTERISTICS (Note 8)						
Gate Threshold Voltage	$V_{GS(TH)}$	0.4	0.7	1.0	V	$V_{DS} = V_{GS}, I_D = 250\mu A$
Static Drain-Source On-Resistance	$R_{DS(ON)}$	—	14.1	17.0	m Ω	$V_{GS} = 3.3V, I_D = 5.0A$
		—	14.4	19.0		$V_{GS} = 3.0V, I_D = 5.0A$
		—	15.5	21.0		$V_{GS} = 2.5V, I_D = 5.0A$
		—	16.0	23.0		$V_{GS} = 2.3V, I_D = 5.0A$
		—	16.8	24.0		$V_{GS} = 2.1V, I_D = 5.0A$
		—	21.3	34.0		$V_{GS} = 2.1V, I_D = 5.0A, +125^\circ C$ (Note 9)
		—	20.0	30.0		$V_{GS} = 1.8V, I_D = 3.0A$
Forward Transfer Admittance	$ Y_{fs} $	—	6.6	—	S	$V_{DS} = 6V, I_S = 1.0A$
Body Diode Forward Voltage	V_{SD}	—	0.7	1	V	$V_{GS} = 0V, I_S = 1.0A$
DYNAMIC CHARACTERISTICS (Note 9)						
Input Capacitance	C_{iss}	—	1002	1503	pF	$V_{DS} = 6V, V_{GS} = 0V,$ $f = 1.0MHz$
Output Capacitance	C_{oss}	—	312	468	pF	
Reverse Transfer Capacitance	C_{rss}	—	259	389	pF	
Gate Resistance	R_g	—	2.2	4.4	Ω	$V_{DS} = 0V, V_{GS} = 0V, f = 1MHz$
Total Gate Charge	Q_g	—	10.5	16	nC	$V_{GS} = 3.3V, V_{DS} = 6V,$ $I_D = 5.0A$
Gate-Source Charge	Q_{gs}	—	1.0	1.5	nC	
Gate-Drain Charge	Q_{gd}	—	4.1	6.2	nC	
Turn-On Delay Time	$t_{D(ON)}$	—	3.7	10	ns	$V_{DD} = 6V, I_D = 5.0A$ $V_{GEN} = 4.5V, R_G = 1\Omega, R_L = 1.2\Omega$
Turn-On Rise Time	t_R	—	6.3	15	ns	
Turn-Off Delay Time	$t_{D(OFF)}$	—	17.9	35	ns	
Turn-Off Fall Time	t_F	—	7.5	15	ns	
Reverse Recovery Charge	Q_{RR}	—	2.7	5	nC	
Body Diode Reverse Recovery Time	t_{RR}	—	14.2	28	ns	$I_F = 5A, di/dt = 100A/\mu s$

- Notes:
- Device mounted on FR-4 substrate PC board, 2oz copper, with minimum recommended pad layout.
 - Device mounted on FR-4 substrate PC board, 2oz copper, with 1inch square copper plate.
 - Short duration pulse test used to minimize self-heating effect.
 - Guaranteed by design. Not subject to production testing.

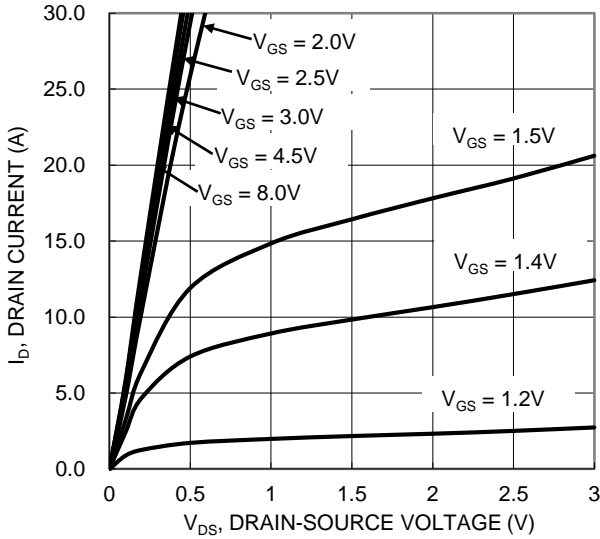

Figure 1. Typical Output Characteristic

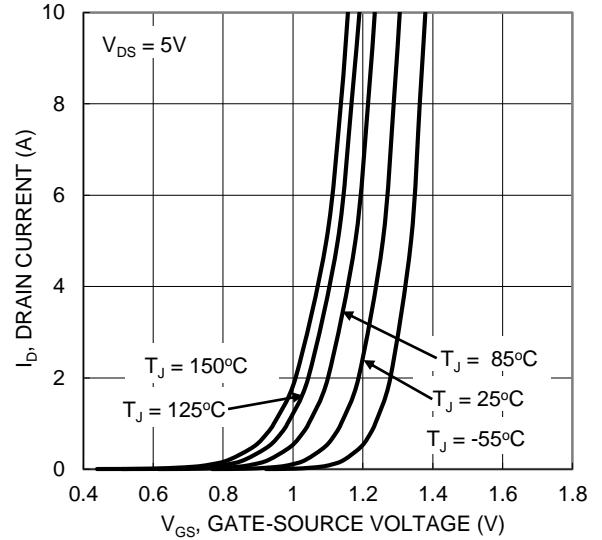

Figure 2. Typical Transfer Characteristic

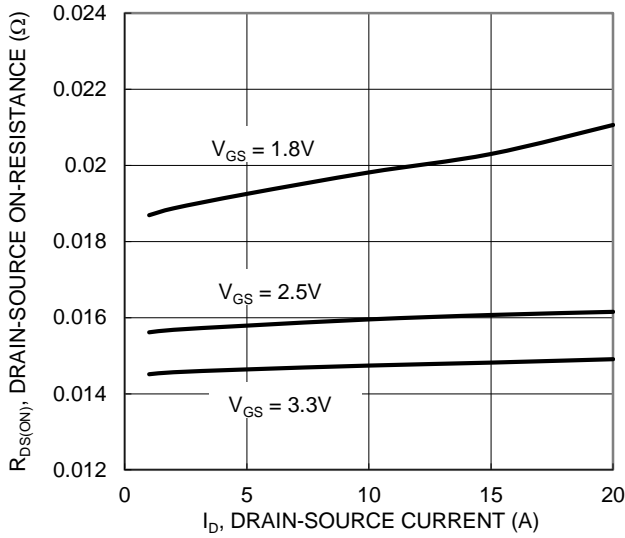

Figure 3. Typical On-Resistance vs. Drain Current and Gate Voltage

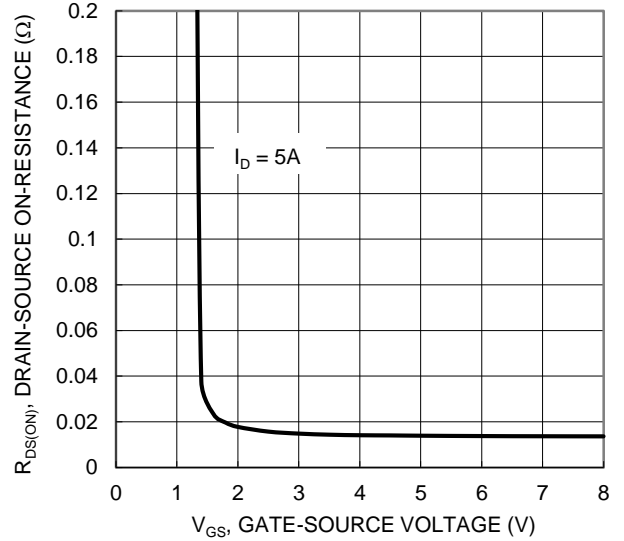

Figure 4. Typical Transfer Characteristic

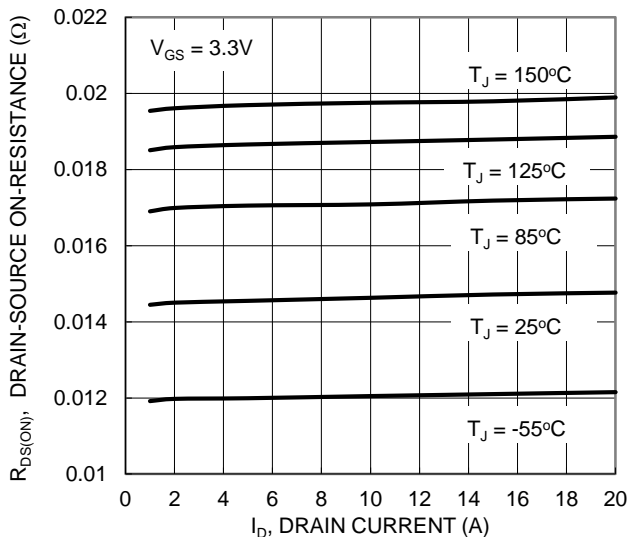

Figure 5. Typical On-Resistance vs. Drain Current and Junction Temperature

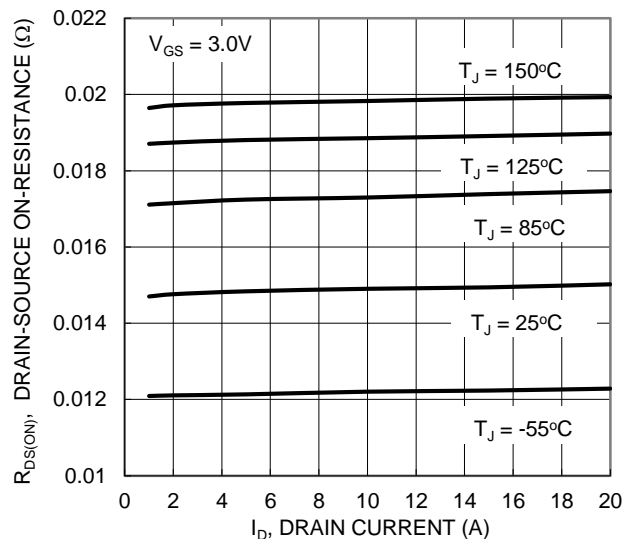

Figure 6. Typical On-Resistance vs. Drain Current and Junction Temperature

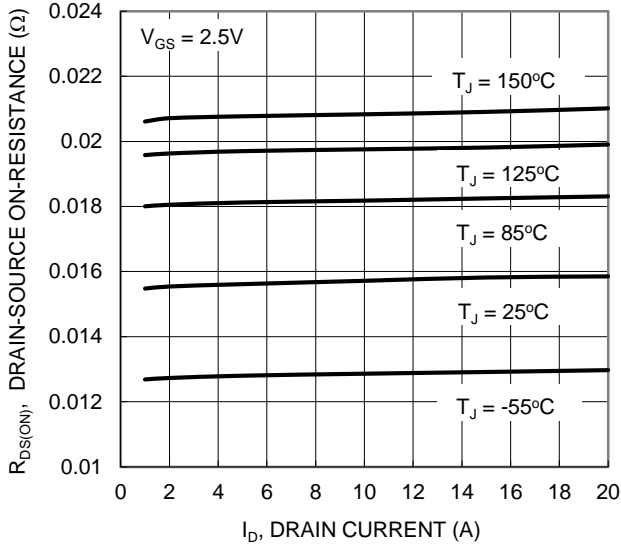

Figure 7. Typical On-Resistance vs. Drain Current and Junction Temperature

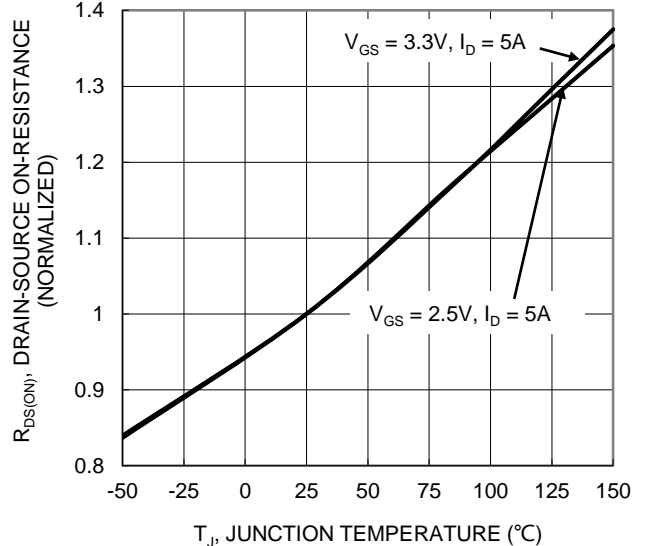

Figure 8. On-Resistance Variation with Junction Temperature

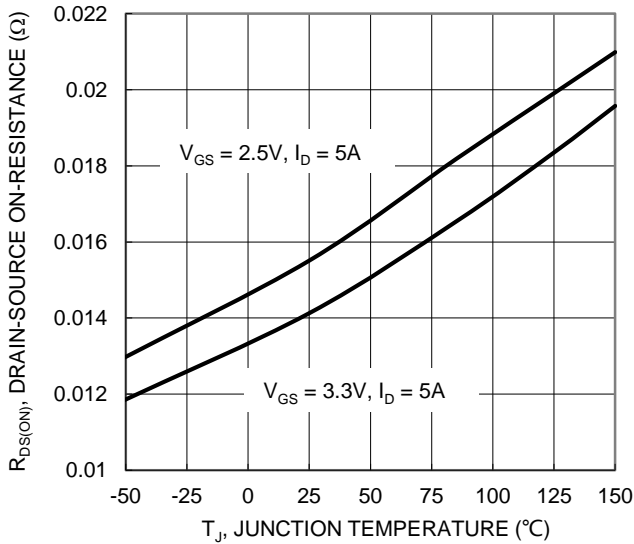

Figure 9. On-Resistance Variation with Junction Temperature

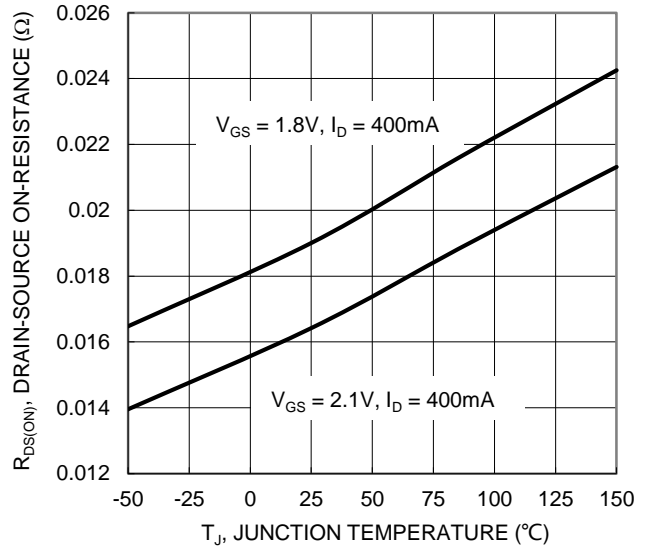

Figure 10. On-Resistance Variation with Junction Temperature

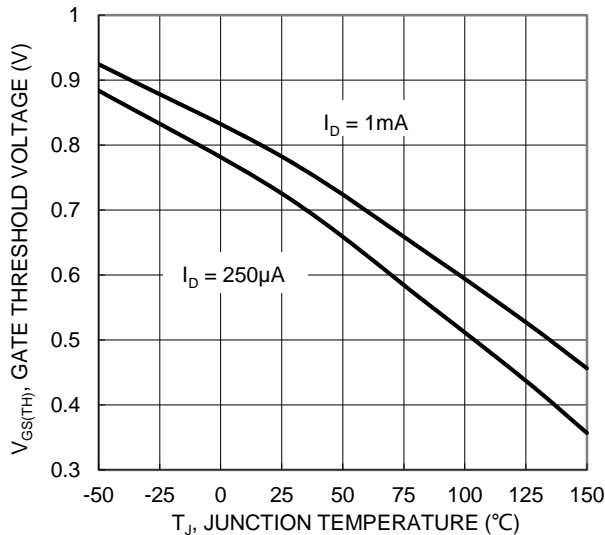

Figure 11. Gate Threshold Variation vs. Junction Temperature

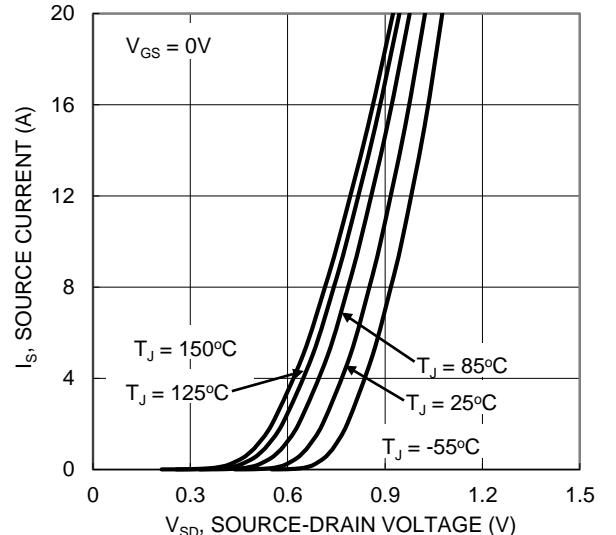

Figure 12. Diode Forward Voltage vs. Current

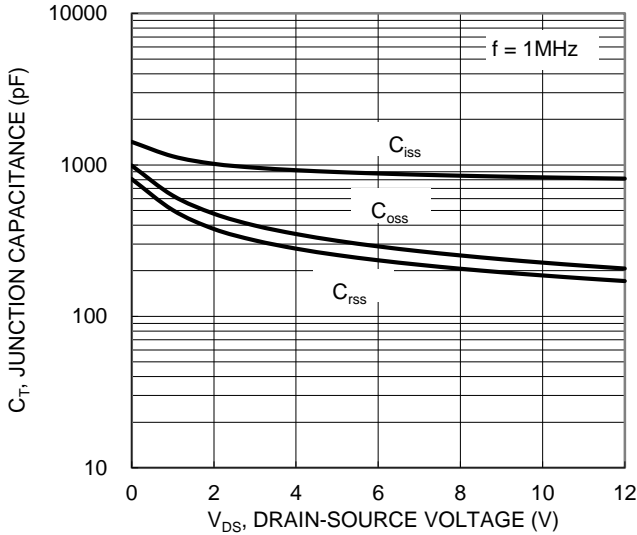

Figure 13. Typical Junction Capacitance

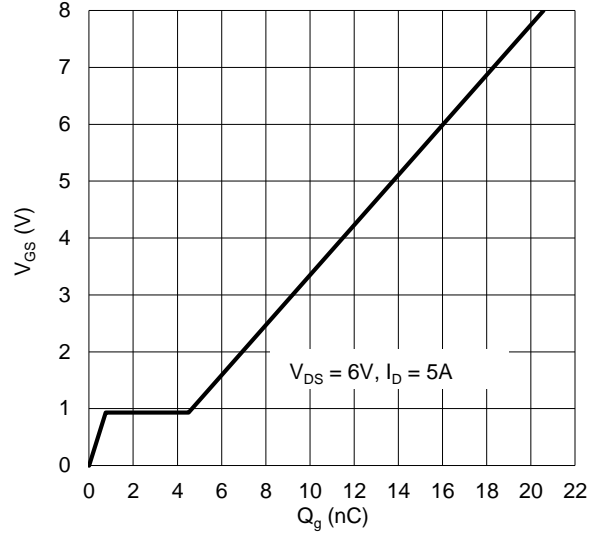

Figure 14. Gate Charge

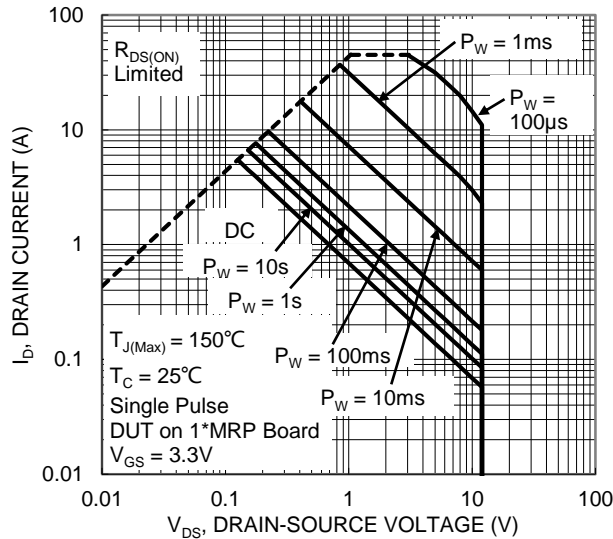

Figure 15. SOA, Safe Operation Area

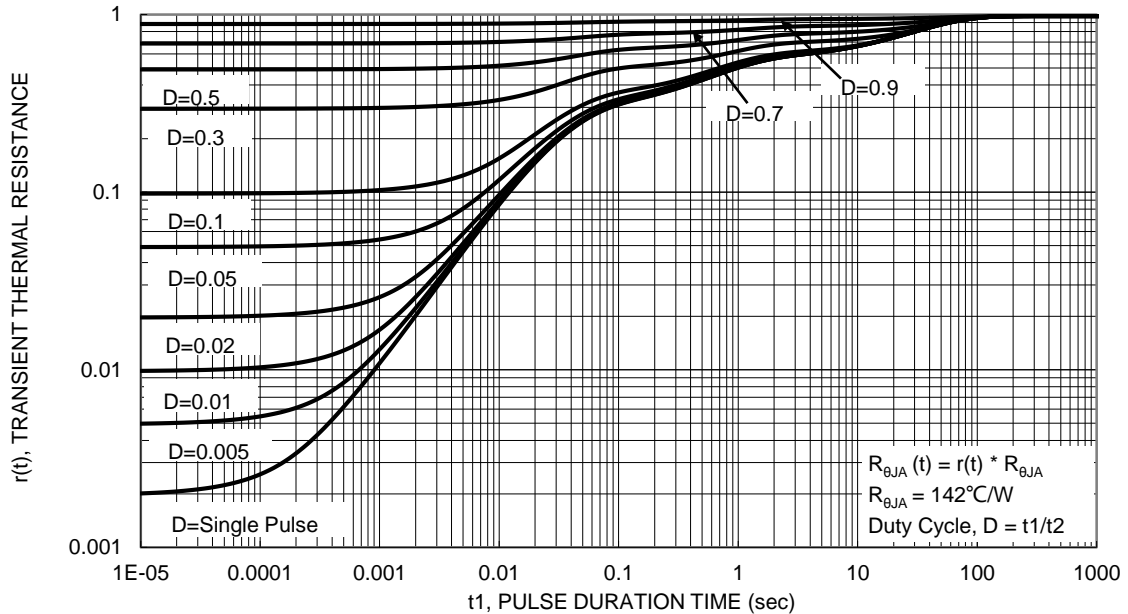
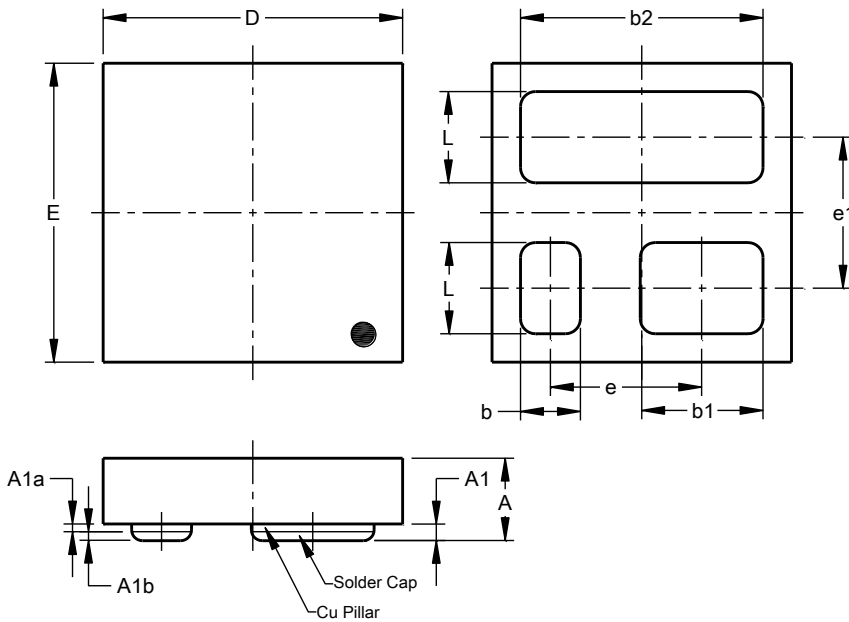

Figure 16. Transient Thermal Resistance

Package Outline Dimensions

Please see <http://www.diodes.com/package-outlines.html> for the latest version.

X3-DSN1010-3



X3-DSN1010-3			
Dim	Min	Max	Typ
A	-	0.29	0.27
A1	0.034	0.046	0.04
A1a	0.015	0.025	0.02
A1b	0.017	0.023	0.02
b	0.18	0.22	0.20
b1	0.39	0.43	0.41
b2	0.79	0.83	0.81
D	0.92	1.00	0.96
E	0.92	1.00	0.96
e	-	-	0.505
e1	-	-	0.505
L	0.285	0.325	0.305
All Dimensions in mm			

Suggested Pad Layout

Please see <http://www.diodes.com/package-outlines.html> for the latest version.

X3-DSN1010-3

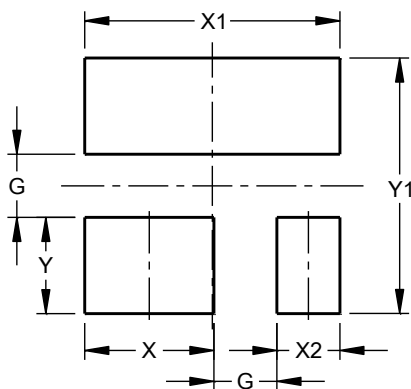

Dimensions	Value (in mm)
G	0.200
X	0.410
X1	0.810
X2	0.200
Y	0.305
Y1	0.810

IMPORTANT NOTICE

1. DIODES INCORPORATED AND ITS SUBSIDIARIES (“DIODES”) MAKE NO WARRANTY OF ANY KIND, EXPRESS OR IMPLIED, WITH REGARDS TO ANY INFORMATION CONTAINED IN THIS DOCUMENT, INCLUDING, BUT NOT LIMITED TO, THE IMPLIED WARRANTIES OF MERCHANTABILITY, FITNESS FOR A PARTICULAR PURPOSE OR NON-INFRINGEMENT OF THIRD PARTY INTELLECTUAL PROPERTY RIGHTS (AND THEIR EQUIVALENTS UNDER THE LAWS OF ANY JURISDICTION).
2. The Information contained herein is for informational purpose only and is provided only to illustrate the operation of Diodes products described herein and application examples. Diodes does not assume any liability arising out of the application or use of this document or any product described herein. This document is intended for skilled and technically trained engineering customers and users who design with Diodes products. Diodes products may be used to facilitate safety-related applications; however, in all instances customers and users are responsible for (a) selecting the appropriate Diodes products for their applications, (b) evaluating the suitability of the Diodes products for their intended applications, (c) ensuring their applications, which incorporate Diodes products, comply the applicable legal and regulatory requirements as well as safety and functional-safety related standards, and (d) ensuring they design with appropriate safeguards (including testing, validation, quality control techniques, redundancy, malfunction prevention, and appropriate treatment for aging degradation) to minimize the risks associated with their applications.
3. Diodes assumes no liability for any application-related information, support, assistance or feedback that may be provided by Diodes from time to time. Any customer or user of this document or products described herein will assume all risks and liabilities associated with such use, and will hold Diodes and all companies whose products are represented herein or on Diodes’ websites, harmless against all damages and liabilities.
4. Products described herein may be covered by one or more United States, international or foreign patents and pending patent applications. Product names and markings noted herein may also be covered by one or more United States, international or foreign trademarks and trademark applications. Diodes does not convey any license under any of its intellectual property rights or the rights of any third parties (including third parties whose products and services may be described in this document or on Diodes’ website) under this document.
5. Diodes products are provided subject to Diodes’ Standard Terms and Conditions of Sale (<https://www.diodes.com/about/company/terms-and-conditions/terms-and-conditions-of-sales/>) or other applicable terms. This document does not alter or expand the applicable warranties provided by Diodes. Diodes does not warrant or accept any liability whatsoever in respect of any products purchased through unauthorized sales channel.
6. Diodes products and technology may not be used for or incorporated into any products or systems whose manufacture, use or sale is prohibited under any applicable laws and regulations. Should customers or users use Diodes products in contravention of any applicable laws or regulations, or for any unintended or unauthorized application, customers and users will (a) be solely responsible for any damages, losses or penalties arising in connection therewith or as a result thereof, and (b) indemnify and hold Diodes and its representatives and agents harmless against any and all claims, damages, expenses, and attorney fees arising out of, directly or indirectly, any claim relating to any noncompliance with the applicable laws and regulations, as well as any unintended or unauthorized application.
7. While efforts have been made to ensure the information contained in this document is accurate, complete and current, it may contain technical inaccuracies, omissions and typographical errors. Diodes does not warrant that information contained in this document is error-free and Diodes is under no obligation to update or otherwise correct this information. Notwithstanding the foregoing, Diodes reserves the right to make modifications, enhancements, improvements, corrections or other changes without further notice to this document and any product described herein. This document is written in English but may be translated into multiple languages for reference. Only the English version of this document is the final and determinative format released by Diodes.
8. Any unauthorized copying, modification, distribution, transmission, display or other use of this document (or any portion hereof) is prohibited. Diodes assumes no responsibility for any losses incurred by the customers or users or any third parties arising from any such unauthorized use.

Copyright © 2021 Diodes Incorporated

www.diodes.com