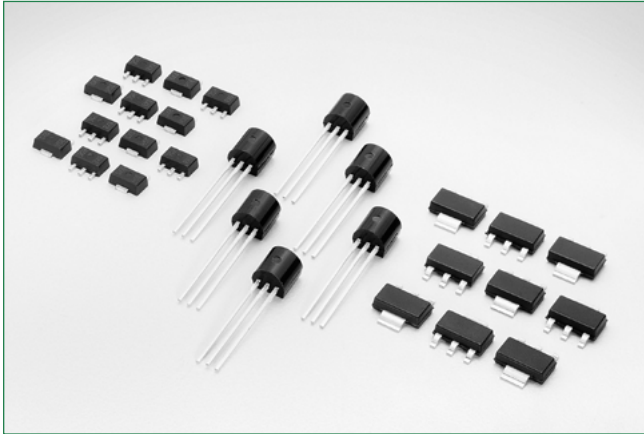

Sx02xSx EV Series

EV Series 1.5 Amp Sensitive SCRs

HF RoHS

Description

This new 1.5A sensitive gate SCR component series offers high static dv/dt and low turn-off time (t_q) All SCR junctions are glass-passivated to ensure long term reliability and parametric stability.

Features

- Surge capability > 15Amps
- Blocking voltage (V_{DRM}/V_{RRM}) capability — up to 600V
- High dv/dt noise immunity
- Improved turn-off time (t_q) < 35 μsec.
- Sensitive gate for direct microprocessor interface
- Thru hole and surface mount packages
- RoHS compliant and Halogen-Free

Additional Information



Resources



Accessories



Samples

Main Features

| Symbol | Value | Unit |
|------------------------------------|------------|------|
| I _{T(RMS)} | 1.5 | A |
| V _{DRM} /V _{RRM} | 400 or 600 | V |
| I _{GT} | 200 | μA |

Applications

The Sx02xSx EV series is specifically designed for solenoid drive often seen in GFCI and similar safety cut-off devices.

Schematic Symbol

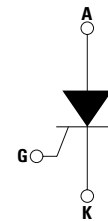

Absolute Maximum Ratings

| Symbol | Parameter | Value | Unit | |
|---------------------|--|--|------------|------------------|
| I _{T(RMS)} | RMS on-state current (full sine wave) | TO-92 T _c = 65°C | 1.5 | A |
| | | SOT-89 T _c = 80°C | | |
| | | SOT-223 T _c = 95°C | | |
| I _{T(AV)} | Average on-state current | TO-92 T _c = 65°C | 0.95 | A |
| | | SOT-89 T _c = 80°C | | |
| | | SOT-223 T _c = 95°C | | |
| I _{TSM} | Non repetitive surge peak on-state current (Single cycle, T _j initial = 25°C) | TO-92 F = 50 Hz | 12.5 | A |
| | | SOT-89 F = 60 Hz | | |
| | | SOT-223 F = 60 Hz | | |
| I ² t | I ² t Value for fusing | t _p = 10 ms F = 50 Hz | 0.78 | A ² s |
| | | t _p = 8.3 ms F = 60 Hz | | |
| di/dt | Critical rate of rise of on-state current I _G = 10mA | TO-92 SOT-89 SOT-223 T _j = 125°C | 50 | A/μs |
| I _{GM} | Peak gate current | t _p = 10 μs T _j = 125°C | 1.0 | A |
| P _{G(AV)} | Average gate power dissipation | T _j = 125°C | 0.1 | W |
| T _{stg} | Storage junction temperature range | | -40 to 150 | °C |
| T _j | Operating junction temperature range | | -40 to 125 | °C |

Sx02xSx EV Series

EV Series 1.5 Amp Sensitive SCRs

Electrical Characteristics (T_J = 25°C, unless otherwise specified)

| Symbol | Description | Test Conditions | Sx02xS | | Sx02xS1 | | Sx02xS2 | | Units |
|----------------------|--|--|--------|-----|---------|-----|---------|-----|-------|
| | | | Min | Max | Min | Max | Min | Max | |
| I _{GT} | DC Gate Trigger Current | V _D = 12V; R _L = 60 Ω | 15 | 200 | 15 | 100 | 15 | 50 | μA |
| V _{GT} | DC Gate Trigger Voltage | V _D = 12V; R _L = 60 Ω | — | 0.8 | — | 0.8 | — | 0.8 | V |
| V _{GRRM} | Peak Reverse Gate Voltage | I _{RG} = 10μA | 5 | — | 5 | — | 5 | — | V |
| I _H | Holding Current | R _{GK} = 1 kΩ | — | 5 | — | 3 | — | 3 | mA |
| (dv/dt) _s | "Critical Rate-of-Rise of Off-State Voltage" | "T _J = 125°C V _D = V _{DRM} / V _{RRM} Exponential Waveform R _{GK} = 1 kΩ" | 25 | — | 25 | — | 25 | — | V/μs |
| t _q | Turn-Off Time | "T _J = 125°C @ 600 V R _{GK} = 1 kΩ" | — | 35 | — | 35 | — | 35 | μs |
| t _{gt} | Turn-On Time | "I _G = 10mA PW = 15μsec I _T = 3.0A (pk)" | — | 3 | — | 3 | — | 3 | μs |
| V _{GD} | Gate Non-Trigger Voltage | "V _D = V _{DRM} , T _J = 125°C, R _L = 3.3kΩ" | 0.2 | — | 0.2 | — | 0.2 | — | V |

x0 = voltage/10

Static Characteristics (T_J = 25°C, unless otherwise specified)

| Symbol | Description | Test Conditions | Value | | Unit |
|------------------|------------------------------------|--|-------|------|------|
| | | | Min | Max | |
| V _{TM} | Peak On-State Voltage | I _{TM} = 3.0A (pk) | — | 1.70 | V |
| I _{DRM} | Off-State Current, Peak Repetitive | T _J = 25°C @ V _D = V _{DRM} R _{GK} = 1 kΩ | — | 5 | μA |
| | | T _J = 125°C @ V _D = V _{DRM} R _{GK} = 1 kΩ | — | 500 | μA |

Thermal Resistances

| Symbol | Parameter | Test Conditions | Value | Unit | |
|---------------------|-----------------------|---|---------|------|------|
| R _{θ(J-C)} | Junction to case (AC) | I _T = 1.5A _(RMS) ¹ | TO-92 | 50 | °C/W |
| | | | SOT-89 | 35 | |
| | | | SOT-223 | 25 | |
| R _{θ(J-A)} | Junction to ambient | I _T = 1.5A _(RMS) ¹ | TO-92 | 160 | °C/W |
| | | | SOT-89 | 90 | |
| | | | SOT-223 | 60 | |

¹ 60Hz AC resistive load condition, 100% conduction.

Sx02xSx EV Series

EV Series 1.5 Amp Sensitive SCRs

Figure 1: Normalized DC Gate Trigger Current vs. Junction Temperature

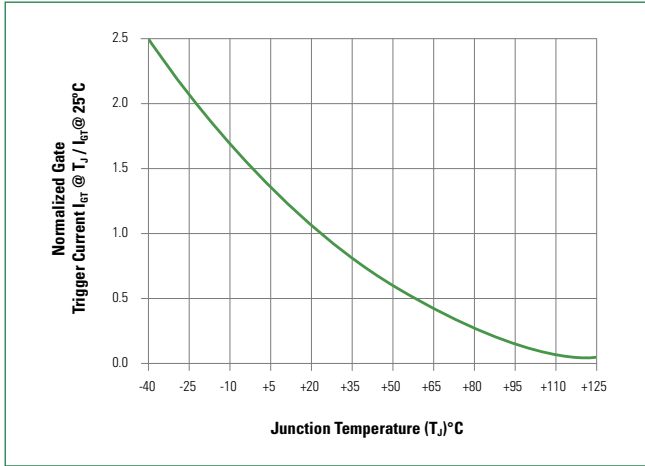

Figure 2: Normalized DC Holding Current vs. Junction Temperature

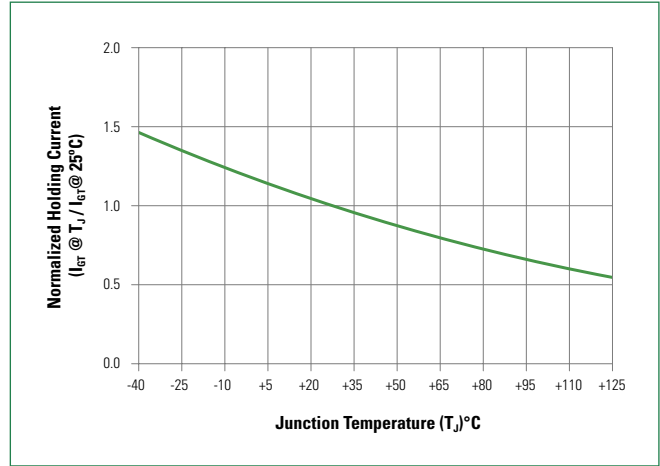

Figure 3: Normalized DC Gate Trigger Voltage vs. Junction Temperature

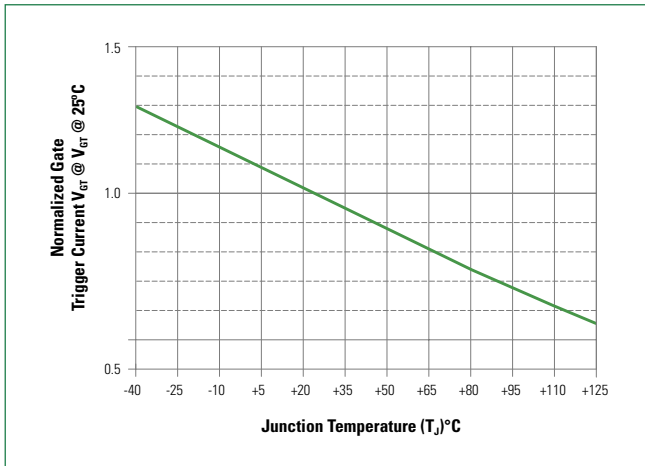

Figure 4: On-State Current vs. On-State Voltage (Typical)

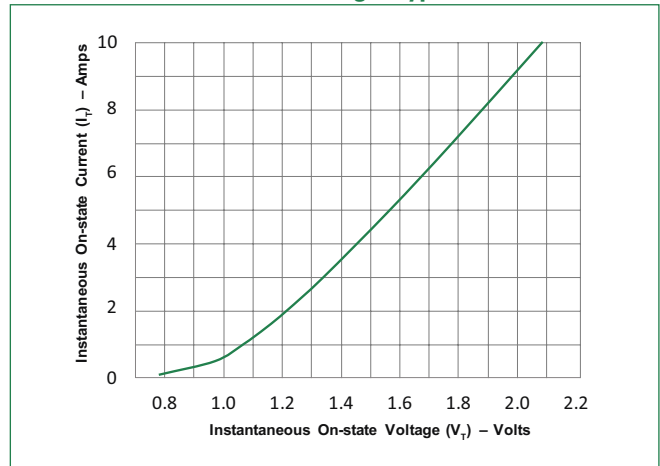

Figure 5: Power Dissipation (Typical) vs. RMS On-State Current

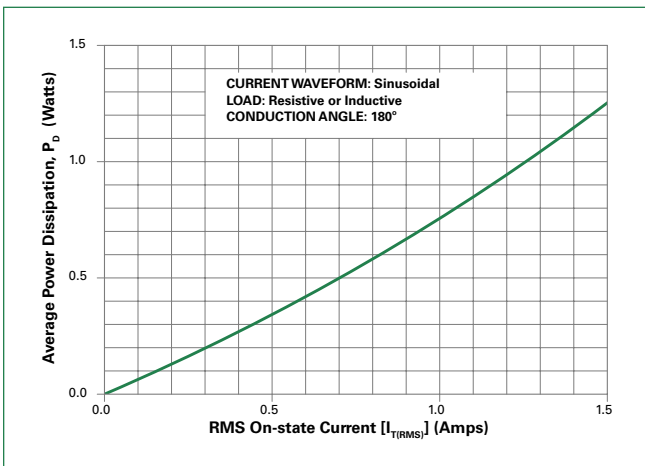
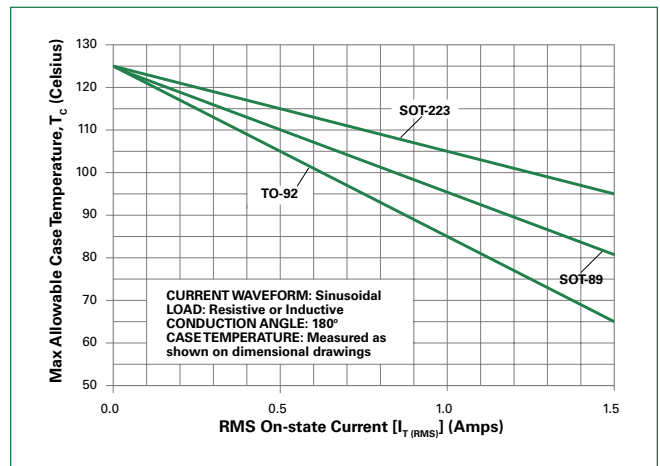

Figure 6: Maximum Allowable Case Temperature vs. On-State Current



Sx02xSx EV Series

EV Series 1.5 Amp Sensitive SCRs

Figure 7: Typical DC Gate Trigger Current with R_{GK} vs. Junction Temperature for Sx02xS

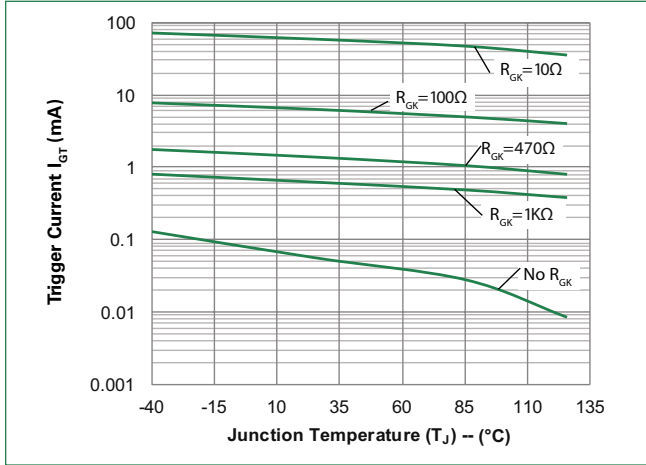

Figure 8: Typical DC Holding Current with R_{GK} vs. Junction Temperature for Sx02xS

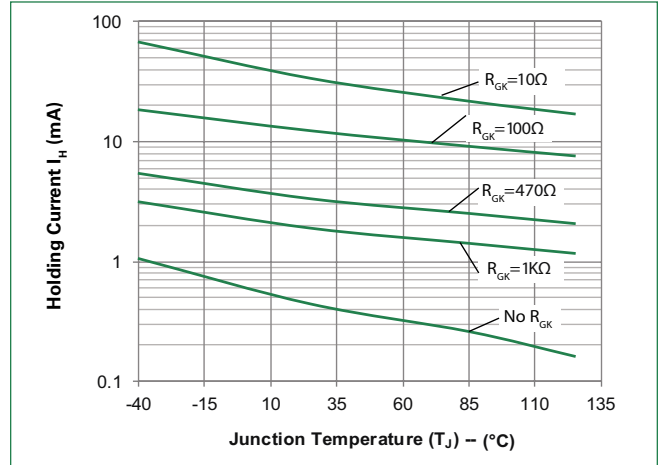

Figure 9: Typical Static dv/dt with R_{GK} vs. Junction Temperature for Sx02xS

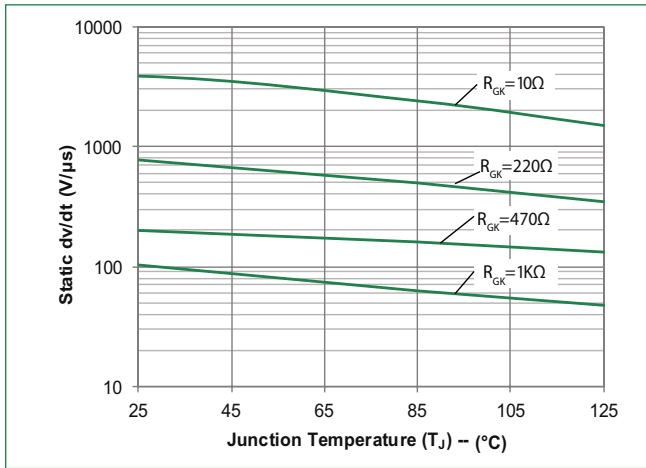

Figure 10: Typical turn off time with R_{GK} vs. Junction Temperature for Sx02xS

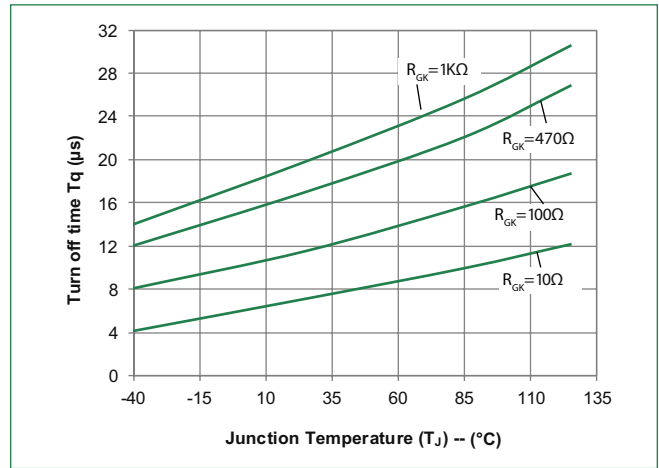
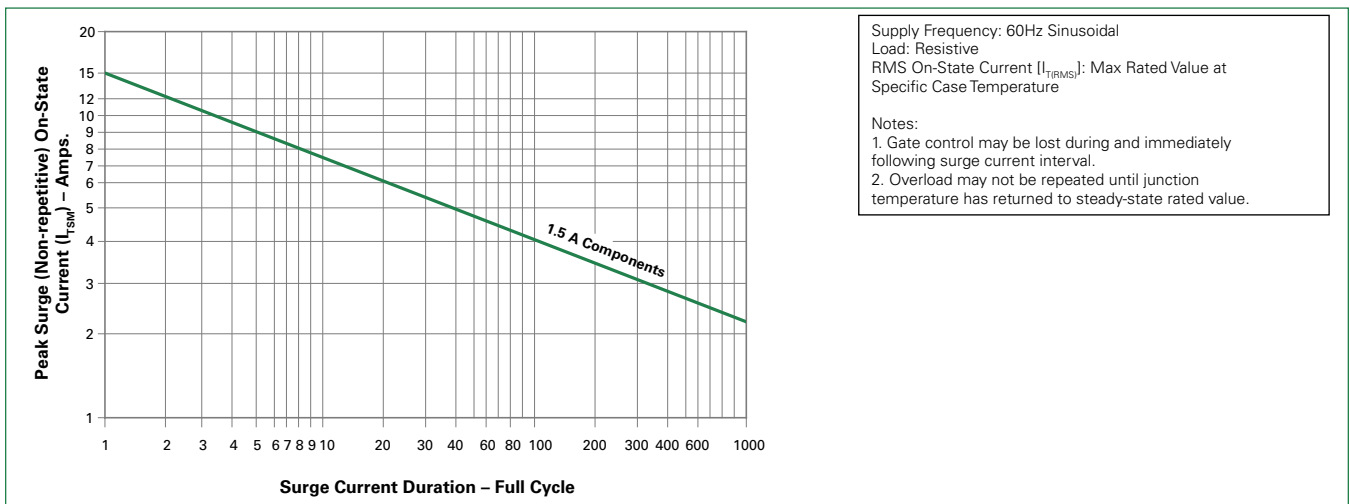

Figure 11: Surge Peak On-State Current vs. Number of Cycles



Sx02xSx EV Series

EV Series 1.5 Amp Sensitive SCRs

Soldering Parameters

| | | |
|--|------------------------------------|-------------------------|
| Reflow Condition | | Pb – Free assembly |
| Pre Heat | - Temperature Min ($T_{s(min)}$) | 150°C |
| | - Temperature Max ($T_{s(max)}$) | 200°C |
| | - Time (min to max) (t_s) | 60 – 180 secs |
| Average ramp up rate (Liquidus Temp) (T_L) to peak | | 5°C/second max |
| $T_{s(max)}$ to T_L - Ramp-up Rate | | 5°C/second max |
| Reflow | - Temperature (T_L) (Liquidus) | 217°C |
| | - Time (min to max) (t_s) | 60 – 150 seconds |
| Peak Temperature (T_p) | | 260 ^{+0/-5} °C |
| Time within 5°C of actual peak Temperature (t_p) | | 20 – 40 seconds |
| Ramp-down Rate | | 5°C/second max |
| Time 25°C to peak Temperature (T_p) | | 8 minutes Max. |
| Do not exceed | | 280°C |

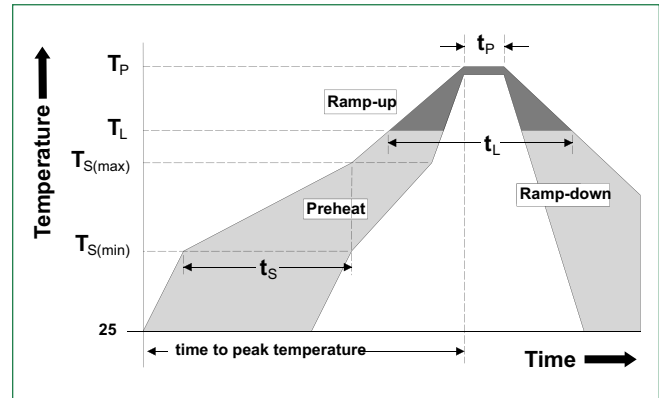

Physical Specifications

| | |
|------------------------|--|
| Terminal Finish | 100% Matte Tin-plated. |
| Body Material | UL Recognized compound meeting flammability rating V-0 |
| Lead Material | Copper Alloy |

Design Considerations

Careful selection of the correct component for the application's operating parameters and environment will go a long way toward extending the operating life of the Thyristor. Good design practice should limit the maximum continuous current through the main terminals to 75% of the component rating. Other ways to ensure long life for a power discrete semiconductor are proper heat sinking and selection of voltage ratings for worst case conditions. Overheating, overvoltage (including dv/dt), and surge currents are the main killers of semiconductors. Correct mounting, soldering, and forming of the leads also help protect against component damage.

Environmental Specifications

| Test | Specifications and Conditions |
|----------------------------------|--|
| AC Blocking | MIL-STD-750, M-1040, Cond A Applied Peak AC voltage @ 125°C for 1008 hours |
| Temperature Cycling | MIL-STD-750, M-1051, 100 cycles; -40°C to +150°C; 15-min dwell-time |
| Temperature/Humidity | EIA / JEDEC, JESD22-A101 1008 hours; 160V - DC; 85°C; 85% rel humidity |
| Resistance to Solder Heat | MIL-STD-750 Method 2031 |
| Solderability | ANSI/J-STD-002, category 3, Test A |
| Lead Bend | MIL-STD-750, M-2036 Cond E |

Sx02xSx EV Series

EV Series 1.5 Amp Sensitive SCRs

Dimensions – TO-92 (E Package)

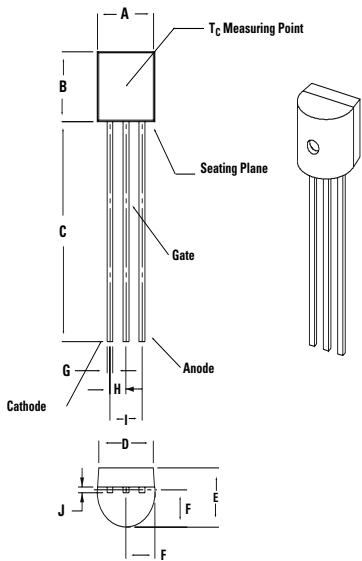

| Dimensions | Inches | | Millimeters | |
|------------|--------|-------|-------------|-------|
| | Min | Max | Min | Max |
| A | 0.175 | 0.205 | 4.450 | 5.200 |
| B | 0.170 | 0.210 | 4.320 | 5.330 |
| C | 0.500 | — | 12.700 | — |
| D | 0.135 | — | 3.430 | — |
| E | 0.125 | 0.165 | 3.180 | 4.190 |
| F | 0.080 | 0.105 | 2.040 | 2.660 |
| G | 0.016 | 0.021 | 0.407 | 0.533 |
| H | 0.045 | 0.055 | 1.150 | 1.390 |
| I | 0.095 | 0.105 | 2.420 | 2.660 |
| J | 0.015 | 0.020 | 0.380 | 0.500 |

Dimensions – SOT-223

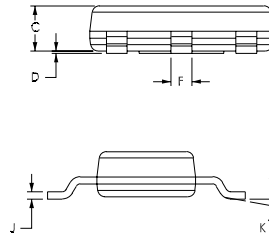
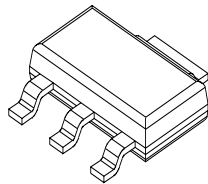
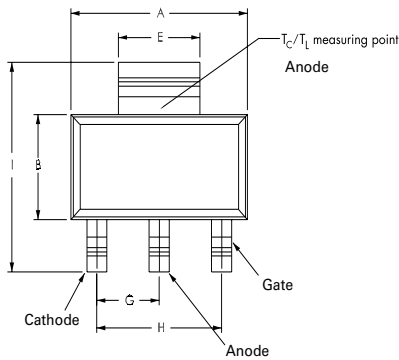

Pad Layout for SOT-223

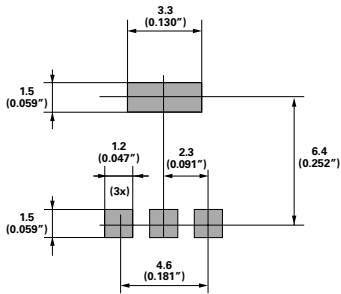

Dimensions in Millimeters (Inches)

| Dimensions | Inches | | | Millimeters | | |
|------------|---------|-------|-------|-------------|------|------|
| | Min | Typ | Max | Min | Typ | Max |
| A | 0.248 | 0.256 | 0.264 | 6.30 | 6.50 | 6.70 |
| B | 0.130 | 0.138 | 0.146 | 3.30 | 3.50 | 3.70 |
| C | — | — | 0.071 | — | — | 1.80 |
| D | 0.001 | — | 0.004 | 0.02 | — | 0.10 |
| E | 0.114 | 0.118 | 0.124 | 2.90 | 3.00 | 3.15 |
| F | 0.024 | 0.027 | 0.034 | 0.60 | 0.70 | 0.85 |
| G | — | 0.090 | — | — | 2.30 | — |
| H | — | 0.181 | — | — | 4.60 | — |
| I | 0.264 | 0.276 | 0.287 | 6.70 | 7.00 | 7.30 |
| J | 0.009 | 0.010 | 0.014 | 0.24 | 0.26 | 0.35 |
| K | 10° MAX | | | | | |

Sx02xSx EV Series

EV Series 1.5 Amp Sensitive SCRs

Dimensions – SOT-89

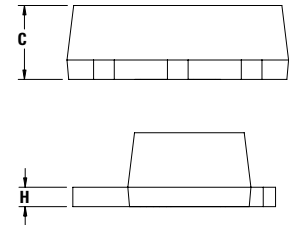
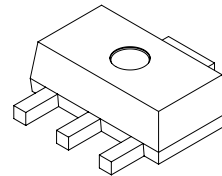
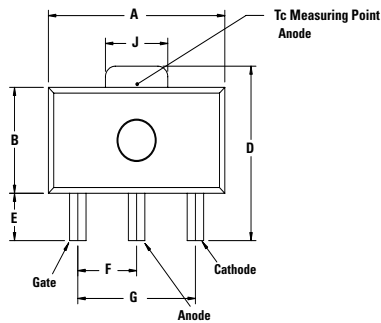

Pad Layout for SOT-89

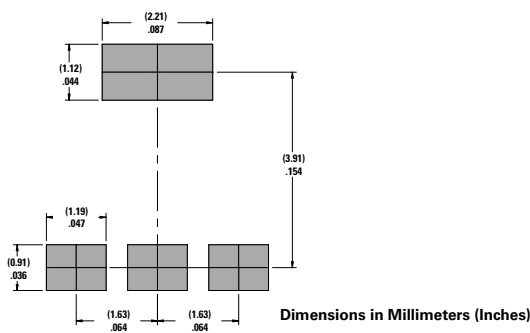

| Dimension | Inches | | | Millimeters | | |
|-----------|--------|-----|-------|-------------|-----|------|
| | Min | Typ | Max | Min | Typ | Max |
| A | 0.173 | — | 0.181 | 4.40 | — | 4.60 |
| B | 0.090 | — | 0.102 | 2.29 | — | 2.60 |
| C | 0.055 | — | 0.063 | 1.40 | — | 1.60 |
| D | 0.155 | — | 0.167 | 3.94 | — | 4.25 |
| E | 0.035 | — | 0.047 | 0.89 | — | 1.20 |
| F | 0.056 | — | 0.062 | 1.42 | — | 1.57 |
| G | 0.115 | — | 0.121 | 2.92 | — | 3.07 |
| H | 0.014 | — | 0.017 | 0.35 | — | 0.44 |
| I | 0.014 | — | 0.019 | 0.36 | — | 0.48 |
| J | 0.064 | — | 0.072 | 1.62 | — | 1.83 |

Product Selector

| Part Numbr | Voltage | | Gate Sensitivity | Package |
|------------|---------|------|------------------|---------|
| | 400V | 600V | | |
| Sx02BS | X | X | 200 μ A | SOT-89 |
| Sx02ES | X | X | 200 μ A | TO-92 |
| Sx02TS | X | X | 200 μ A | SOT-223 |
| Sx02BS1 | X | X | 100 μ A | SOT-89 |
| Sx02ES1 | X | X | 100 μ A | TO-92 |
| Sx02TS1 | X | X | 100 μ A | SOT-223 |
| Sx02BS2 | — | X | 50 μ A | SOT-89 |

Note: x = voltage/100

Packing Options

| Part Number | Marking | Weight | Packing Mode | Base Quantity |
|-------------|---------|---------|--------------|---------------|
| Sx02ESy | Sx02ESy | 0.217 g | Bulk | 2500 |
| Sx02ESyAP | Sx02ESy | 0.217 g | Ammo Pack | 2000 |
| Sx02ESyRP | Sx02ESy | 0.217 g | Tape & Reel | 2000 |
| Sx02TSyRP | Sx02TSy | 0.120 g | Tape & Reel | 1000 |
| Sx02BSyRP | x02y | 0.053 g | Tape & Reel | 1000 |
| Sx02BSyRP1 | x02y | 0.053 g | Tape & Reel | 1000 |

Sx02xSx EV Series

EV Series 1.5 Amp Sensitive SCRs

TO-92 (3-lead) Reel Pack (RP) Radial Leaded Specifications

Meets all EIA-468-C Standards

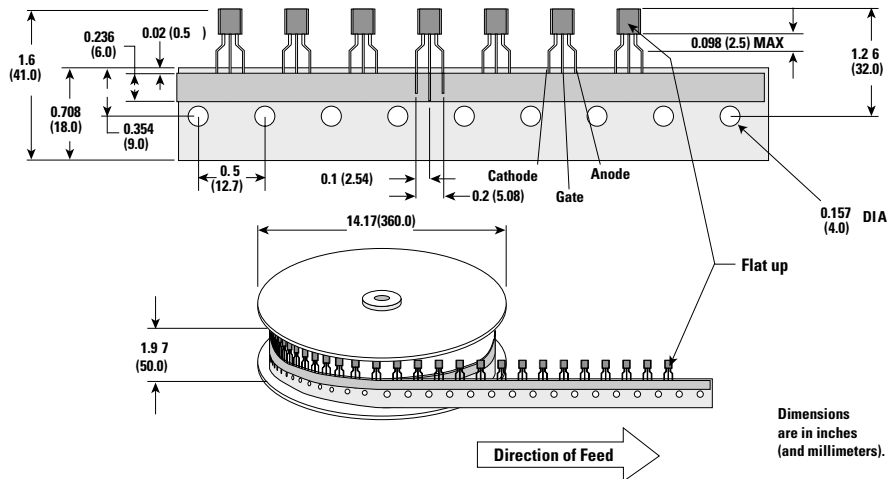

SOT-89 Reel Pack (RP) Specifications

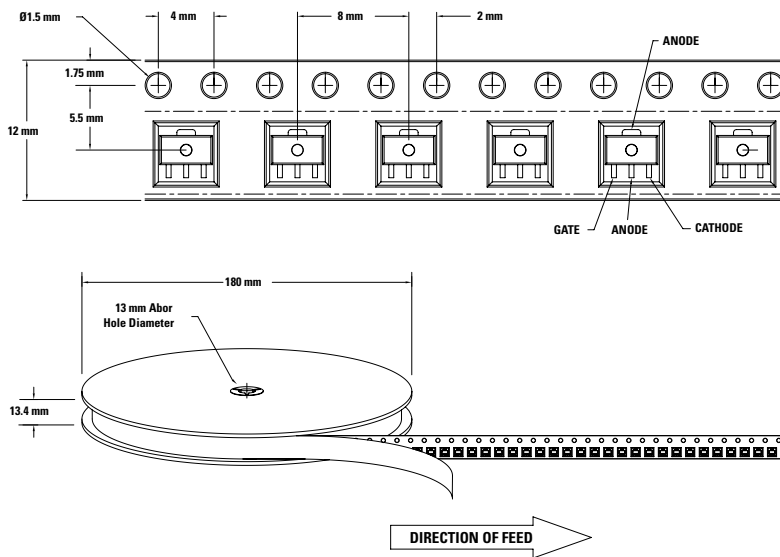

Sx02xSx EV Series

EV Series 1.5 Amp Sensitive SCRs

SOT-89 Reel Pack (RP1) Specifications

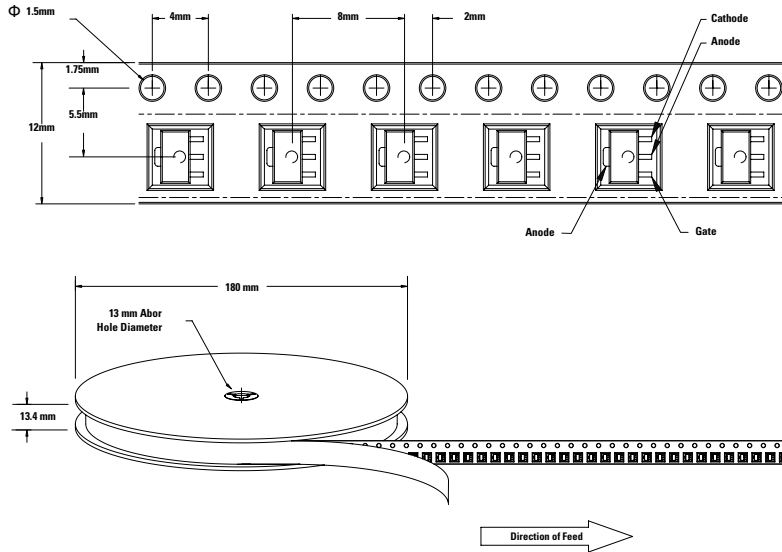

TO-92 (3-lead) Ammo Pack (AP) Radial Leaded Specifications

Meets all EIA-468-C Standards

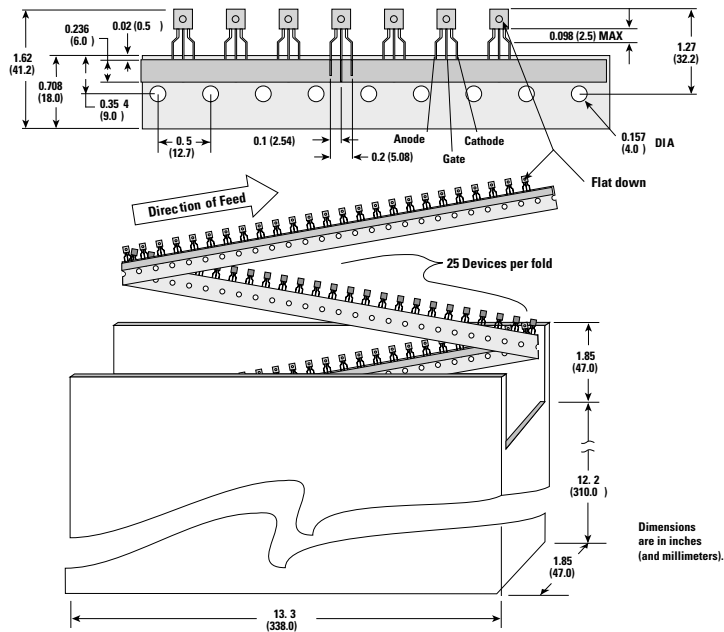

Sx02xSx EV Series

EV Series 1.5 Amp Sensitive SCRs

SOT-223 Reel Pack (RP) Specifications

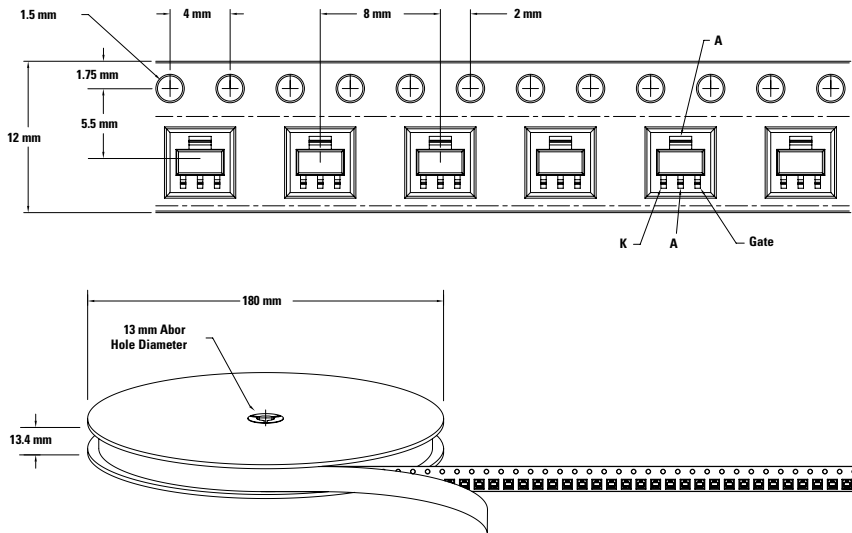

Part Numbering System

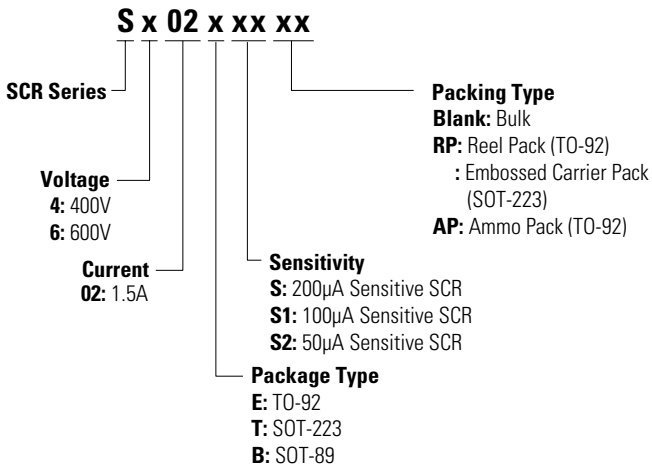

Part Marking System

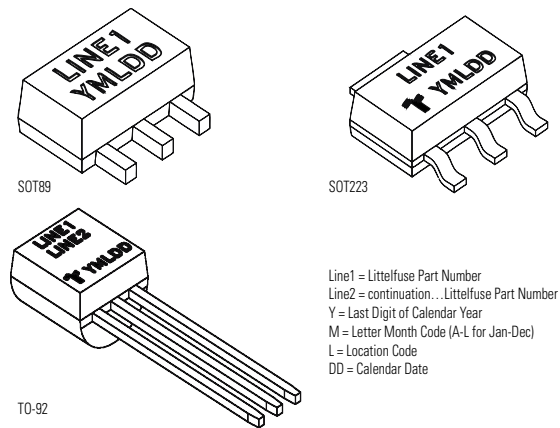

Disclaimer Notice - Information furnished is believed to be accurate and reliable. However, users should independently evaluate the suitability of and test each product selected for their own applications. Littelfuse products are not designed for, and may not be used in, all applications. Read complete Disclaimer Notice at www.littelfuse.com/disclaimer-electronics.