

# TL1451A-Q1 DUAL PULSE-WIDTH-MODULATION CONTROL CIRCUITS

SGLS304A – JUNE 2005 – REVISED JUNE 2008

- Qualified for Automotive Applications
- Complete PWM Power Control Circuitry
- Completely Synchronized Operation
- Internal Undervoltage Lockout Protection
- Wide Supply Voltage Range
- Internal Short-Circuit Protection
- Oscillator Frequency . . . 500 kHz Max
- Variable Dead Time Provides Control Over Total Range
- Internal Regulator Provides a Stable 2.5-V Reference Supply
- Available in Q-Temp Automotive HighRel Automotive Applications Configuration Control / Print Support Qualification to Automotive Standards

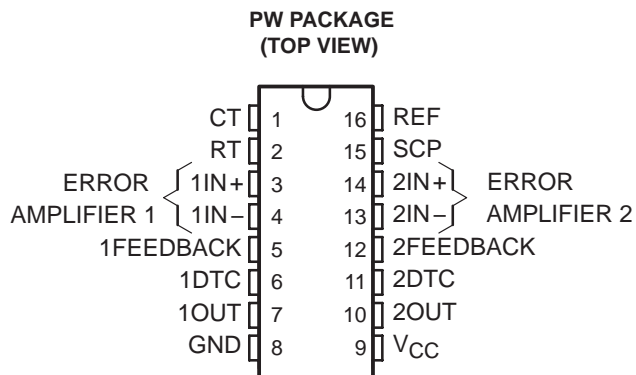

## description

The TL1451A incorporates on a single monolithic chip all the functions required in the construction of two pulse-width-modulation (PWM) control circuits. Designed primarily for power-supply control, the TL1451A contains an on-chip 2.5-V regulator, two error amplifiers, an adjustable oscillator, two dead-time comparators, undervoltage lockout circuitry, and dual common-emitter output transistor circuits.

The uncommitted output transistors provide common-emitter output capability for each controller. The internal amplifiers exhibit a common-mode voltage range from 1.04 V to 1.45 V. The dead-time control (DTC) comparator has no offset unless externally altered and can provide 0% to 100% dead time. The on-chip oscillator can be operated by terminating RT and CT. During low  $V_{CC}$  conditions, the undervoltage lockout control circuit feature locks the outputs off until the internal circuitry is operational.

The TL1451A is characterized for operation from  $-40^{\circ}\text{C}$  to  $125^{\circ}\text{C}$ .

### AVAILABLE OPTIONS<sup>†</sup>

T <sub>A</sub>	PACKAGED DEVICES <sup>‡</sup>
	TSSOP (PW) <sup>§</sup>
$-40^{\circ}\text{C}$ to $125^{\circ}\text{C}$	TL1451AQPWRQ1

<sup>†</sup> For the most current package and ordering information, see the Package Option Addendum at the end of this document, or see the TI web site at <http://www.ti.com>.

<sup>‡</sup> Package drawings, thermal data, and symbolization are available at <http://www.ti.com/packaging>.

<sup>§</sup> The PW package is only available left-end taped and reeled.



Please be aware that an important notice concerning availability, standard warranty, and use in critical applications of Texas Instruments semiconductor products and disclaimers thereto appears at the end of this data sheet.

PRODUCTION DATA information is current as of publication date. Products conform to specifications per the terms of Texas Instruments standard warranty. Production processing does not necessarily include testing of all parameters.

 **TEXAS  
INSTRUMENTS**  
[www.ti.com](http://www.ti.com)

Copyright © 2008, Texas Instruments Incorporated  
On products compliant to MIL-PRF-38535, all parameters are tested unless otherwise noted. On all other products, production processing does not necessarily include testing of all parameters.

# TL1451A-Q1

## DUAL PULSE-WIDTH-MODULATION CONTROL CIRCUITS

SGLS304A – JUNE 2005 – REVISED JUNE 2008

### functional block diagram

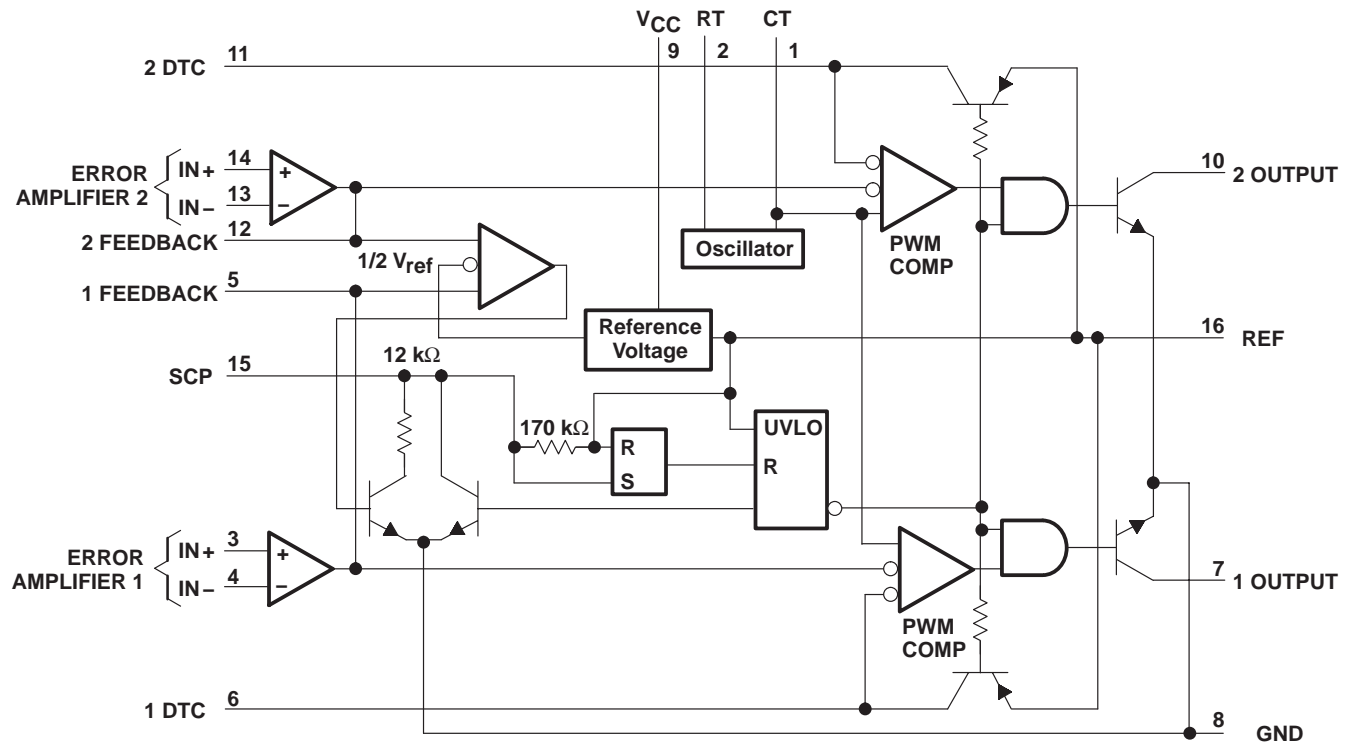

#### COMPONENT COUNT

Resistors	65
Capacitors	8
Transistors	105
JFETs	18

# TL1451A-Q1

## DUAL PULSE-WIDTH-MODULATION CONTROL CIRCUITS

SGLS304A – JUNE 2005 – REVISED JUNE 2008

### absolute maximum ratings over operating free-air temperature range†

Supply voltage, $V_{CC}$ .....	51 V
Amplifier input voltage, $V_I$ .....	20 V
Collector output voltage, $V_O$ .....	51 V
Collector output current, $I_O$ .....	21 mA
Continuous power total dissipation .....	See Dissipation Rating Table
Operating free-air temperature range, $T_A$ .....	-40°C to 125°C
Storage temperature range, $T_{stg}$ .....	-65°C to 150°C
Lead temperature 1,6 mm (1/16 inch) from case for 10 seconds .....	260°C

† Stresses beyond those listed under “absolute maximum ratings” may cause permanent damage to the device. These are stress ratings only, and functional operation of the device at these or any other conditions beyond those indicated under “recommended operating conditions” is not implied. Exposure to absolute-maximum-rated conditions for extended periods may affect device reliability.

**DISSIPATION RATING TABLE**

PACKAGE	$T_A \leq 25^\circ\text{C}$ POWER RATING	DERATING FACTOR ABOVE $T_A = 25^\circ\text{C}$	$T_A = 70^\circ\text{C}$ POWER RATING	$T_A = 85^\circ\text{C}$ POWER RATING	$T_A = 125^\circ\text{C}$ POWER RATING
PW	838 mW	6.7 mW/°C	536 mW	436 mW	168 mW

### recommended operating conditions

	MIN	MAX	UNIT
Supply voltage, $V_{CC}$	3.6	50	V
Amplifier input voltage, $V_I$	1.05	1.45	V
Collector output voltage, $V_O$		50	V
Collector output current, $I_O$		20	mA
Current into feedback terminal		45	$\mu\text{A}$
Feedback resistor, $R_F$	100		k $\Omega$
Timing capacitor, $C_T$	150	15000	pF
Timing resistor, $R_T$	5.1	100	k $\Omega$
Oscillator frequency	1	500	kHz
Operating free-air temperature, $T_A$	-40	125	°C

# TL1451A-Q1

## DUAL PULSE-WIDTH-MODULATION CONTROL CIRCUITS

SGLS304A – JUNE 2005 – REVISED JUNE 2008

electrical characteristics over recommended operating free-air temperature range,  $V_{CC} = 6\text{ V}$ ,  $f = 200\text{ kHz}$  (unless otherwise noted)

### reference section

PARAMETER	TEST CONDITIONS		TL1451AQ			UNIT
			MIN	TYP†	MAX	
Output voltage (pin 16)	$I_O = 1\text{ mA}$	$T_A = 25^\circ\text{C}$	2.4	2.5	2.6	V
		$T_A = \text{MIN and } 125^\circ\text{C}$	2.35	2.46	2.65	
Output voltage change with temperature			-0.63%		$\pm 4\%^\ddagger$	
Input voltage regulation	$V_{CC} = 3.6\text{ V to } 40\text{ V}$	$T_A = 25^\circ\text{C}$		2.0	12.5	mV
		$T_A = 125^\circ\text{C}$		0.7	15	
		$T_A = \text{MIN}$		0.3	30	
Output voltage regulation	$I_O = 0.1\text{ mA to } 1\text{ mA}$	$T_A = 25^\circ\text{C}$		1	7.5	mV
		$T_A = 125^\circ\text{C}$		0.3	14	
		$T_A = \text{MIN}$		0.3	20	
Short-circuit output current	$V_O = 0$		3	10	30	mA

† All typical values are at  $T_A = 25^\circ\text{C}$  unless otherwise indicated.

‡ These parameters are not production tested.

### undervoltage lockout section

PARAMETER	TEST CONDITIONS		TL1451AQ			UNIT
			MIN	TYP†	MAX	
Upper threshold voltage ( $V_{CC}$ )		$T_A = 25^\circ\text{C}$		2.72		V
		$T_A = 125^\circ\text{C}$		1.7		
		$T_A = \text{MIN}$		3.15		
Lower threshold voltage ( $V_{CC}$ )		$T_A = 25^\circ\text{C}$		2.6		V
		$T_A = 125^\circ\text{C}$		1.65		
		$T_A = \text{MIN}$		3.09		
Hysteresis ( $V_{CC}$ )		$T_A = 25^\circ\text{C}$	80	120		mV
		$T_A = 125^\circ\text{C}$	10	50		
		$T_A = \text{MIN}$	10	60		
Reset threshold voltage ( $V_{CC}$ )		$T_A = 25^\circ\text{C}$		1.5		V
		$T_A = 125^\circ\text{C}$		0.95		
		$T_A = \text{MIN}$		1.5		

† All typical values are at  $T_A = 25^\circ\text{C}$  unless otherwise indicated.

# TL1451A-Q1

## DUAL PULSE-WIDTH-MODULATION CONTROL CIRCUITS

SGLS304A – JUNE 2005 – REVISED JUNE 2008

### short-circuit protection control section

PARAMETER	TEST CONDITIONS	TL1451AQ			UNIT
		MIN	TYP†	MAX	
Input threshold voltage (SCP)	$T_A = 25^\circ\text{C}$	650	700	750	mV
	$T_A = 125^\circ\text{C}$	400	478	650	
	$T_A = \text{MIN}$	800	880	950	
Standby voltage (SCP)		140	185	230	mV
Latched input voltage (SCP)	$T_A = 25^\circ\text{C}$		60	120	mV
	$T_A = 125^\circ\text{C}$		70	120	
	$T_A = \text{MIN}$		60	120	
Equivalent timing resistance			170		k $\Omega$
Comparator threshold voltage (FEEDBACK)			1.18		V

† All typical values are at  $T_A = 25^\circ\text{C}$  unless otherwise indicated.

### oscillator section

PARAMETER	TEST CONDITIONS	TL1451AQ			UNIT
		MIN	TYP†	MAX	
Frequency	$C_T = 330\text{ pF}$ , $R_T = 10\text{ k}\Omega$	$T_A = 25^\circ\text{C}$	200		kHz
		$T_A = 125^\circ\text{C}$	195		
		$T_A = \text{MIN}$	193		
Standard deviation of frequency	$C_T = 330\text{ pF}$ , $R_T = 10\text{ k}\Omega$		2%		
Frequency change with voltage	$V_{CC} = 3.6\text{ V to }40\text{ V}$	$T_A = 25^\circ\text{C}$	1%		
		$T_A = 125^\circ\text{C}$	1%		
		$T_A = \text{MIN}$	3%		
Frequency change with temperature			1.37%	$\pm 10\%^\ddagger$	

† All typical values are at  $T_A = 25^\circ\text{C}$  unless otherwise indicated.

‡ These parameters are not production tested.

### dead-time control section

PARAMETER	TEST CONDITIONS	TL1451AQ			UNIT
		MIN	TYP†	MAX	
Input bias current (DTC)	$T_A = 25^\circ\text{C}$			1	$\mu\text{A}$
	$T_A = \text{MIN and } 125^\circ\text{C}$			3	
Latch mode (source) current (DTC)		-80	-145		$\mu\text{A}$
Latched input voltage (DTC)	$T_A = 25^\circ\text{C}$	2.3		V	
	$T_A = 125^\circ\text{C}$	2.22	2.32		
	$T_A = \text{MIN}$	2.28	2.4		
Input threshold voltage at $f = 10\text{ kHz}$ (DTC)	Zero duty cycle		2.05	2.25 <sup>‡</sup>	V
	Maximum duty cycle	1.2 <sup>‡</sup>	1.45		

† All typical values are at  $T_A = 25^\circ\text{C}$  unless otherwise indicated.

‡ These parameters are not production tested.

# TL1451A-Q1

## DUAL PULSE-WIDTH-MODULATION CONTROL CIRCUITS

SGLS304A – JUNE 2005 – REVISED JUNE 2008

### error-amplifier section

PARAMETER	TEST CONDITIONS	TL1451AQ			UNIT
		MIN	TYP†	MAX	
Input offset voltage	$V_O$ (FEEDBACK) = 1.25 V	$T_A = 25^\circ\text{C}$		±7	mV
		$T_A = 125^\circ\text{C}$		±10	
		$T_A = \text{MIN}$		±12	
Input offset current	$V_O$ (FEEDBACK) = 1.25 V	$T_A = 25^\circ\text{C}$		±100	nA
		$T_A = 125^\circ\text{C}$		±100	
		$T_A = \text{MIN}$		±200	
Input bias current	$V_O$ (FEEDBACK) = 1.25 V	$T_A = 25^\circ\text{C}$	160	500	nA
		$T_A = 125^\circ\text{C}$	100	500	
		$T_A = \text{MIN}$	142	700	
Common-mode input voltage range	$V_{CC} = 3.6 \text{ V to } 40 \text{ V}$	1.05 to 1.45			V
Open-loop voltage amplification	$R_F = 200 \text{ k}\Omega$	$T_A = 25^\circ\text{C}$	70	80	dB
		$T_A = 125^\circ\text{C}$	70	80	
		$T_A = \text{MIN}$	64	80	
Unity-gain bandwidth			1.5		MHz
Common-mode rejection ratio		60	80		dB
Positive output voltage swing		2			V
Negative output voltage swing				1	V
Output (sink) current (FEEDBACK)	$V_{ID} = -0.1 \text{ V}, V_O = 1.25 \text{ V}$	$T_A = 25^\circ\text{C}$	0.5	1.6	mA
		$T_A = 125^\circ\text{C}$	0.4	1.8	
		$T_A = \text{MIN}$	0.3	1.7	
Output (source) current (FEEDBACK)	$V_{ID} = 0.1 \text{ V}, V_O = 1.25 \text{ V}$	$T_A = 25^\circ\text{C}$	-45	-70	$\mu\text{A}$
		$T_A = 125^\circ\text{C}$	-25	-50	
		$T_A = \text{MIN}$	-15	-70	

† All typical values are at  $T_A = 25^\circ\text{C}$  unless otherwise indicated.

### output section

PARAMETER	TEST CONDITIONS	TL1451AQ			UNIT
		MIN	TYP†	MAX	
Collector off-state current	$V_O = 50 \text{ V}$			10	$\mu\text{A}$
Output saturation voltage	$T_A = 25^\circ\text{C}$		1.2	2	V
	$T_A = 125^\circ\text{C}$		1.6	2.4	
	$T_A = \text{MIN}$		1.36	2.2	
Short-circuit output current	$V_O = 6 \text{ V}$			90	mA

† All typical values are at  $T_A = 25^\circ\text{C}$  unless otherwise indicated.

### pwm comparator section

PARAMETER	TEST CONDITIONS	TL1451AQ			UNIT
		MIN	TYP†	MAX	
Input threshold voltage at $f = 10 \text{ kHz}$ (FEEDBACK)	Zero duty cycle		2.05	2.25‡	V
	Maximum duty cycle	1.2‡	1.45		

† All typical values are at  $T_A = 25^\circ\text{C}$  unless otherwise indicated.

‡ These parameters are not production tested.

# TL1451A-Q1 DUAL PULSE-WIDTH-MODULATION CONTROL CIRCUITS

SGLS304A – JUNE 2005 – REVISED JUNE 2008

## total device

PARAMETER	TEST CONDITIONS	TL1451AQ		UNIT	
		MIN	TYP†		MAX
Standby supply current	Off-state		1.3	1.8	mA
Average supply current	$R_T = 10\text{ k}\Omega$		1.7	2.4	mA

† All typical values are at  $T_A = 25^\circ\text{C}$  unless otherwise indicated.

## PARAMETER MEASUREMENT INFORMATION

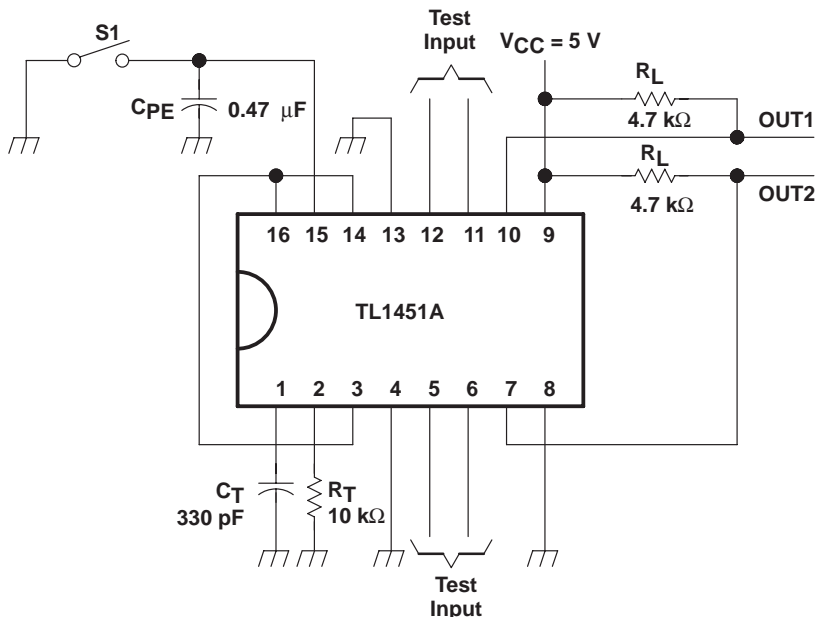
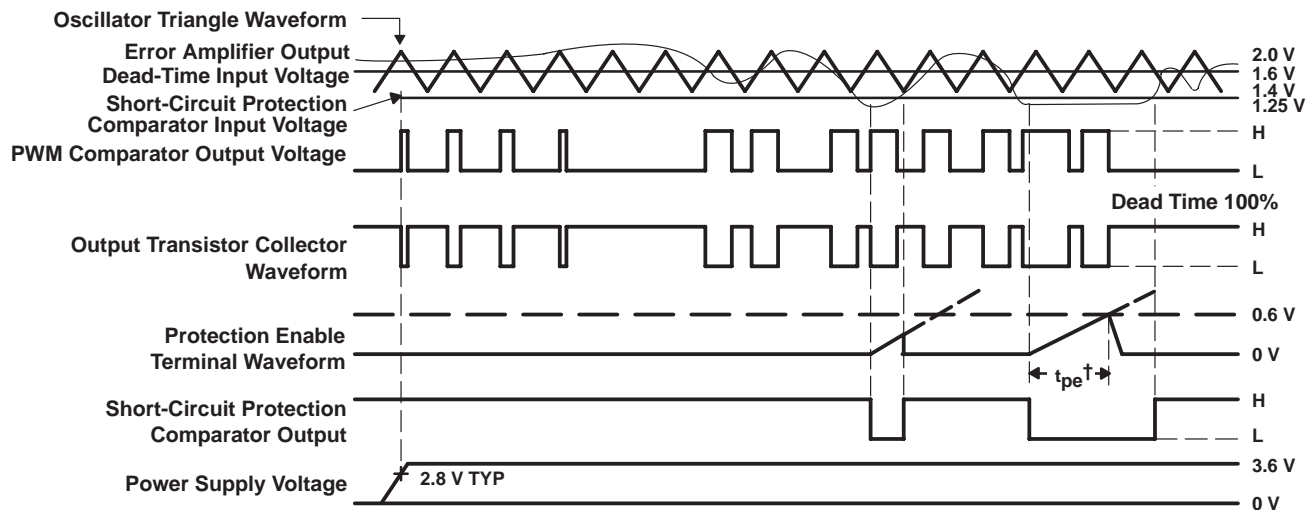

Figure 1. Test Circuit



† Protection Enable Time,  $t_{pe} = (0.051 \times 10^6 \times C_{pe})$  in seconds

Figure 2. TL1451A Timing Diagram

# TL1451A-Q1 DUAL PULSE-WIDTH-MODULATION CONTROL CIRCUITS

SGLS304A – JUNE 2005 – REVISED JUNE 2008

## TYPICAL CHARACTERISTICS

TRIANGLE OSCILLATOR FREQUENCY  
vs  
TIMING RESISTANCE

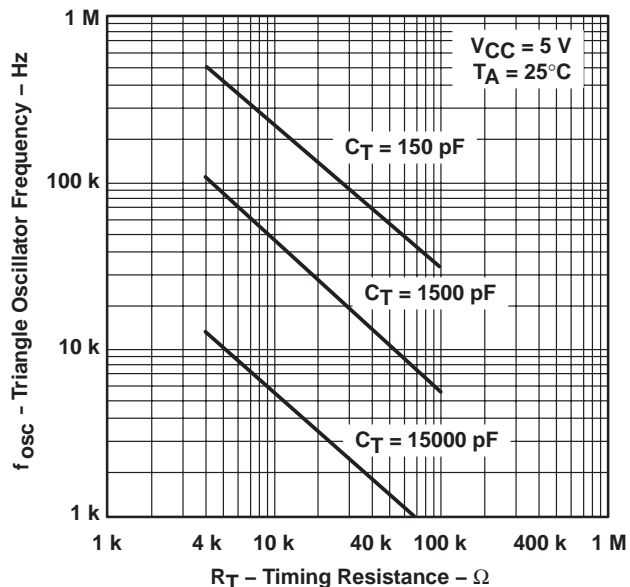

Figure 3

OSCILLATOR FREQUENCY VARIATION  
vs  
FREE-AIR TEMPERATURE

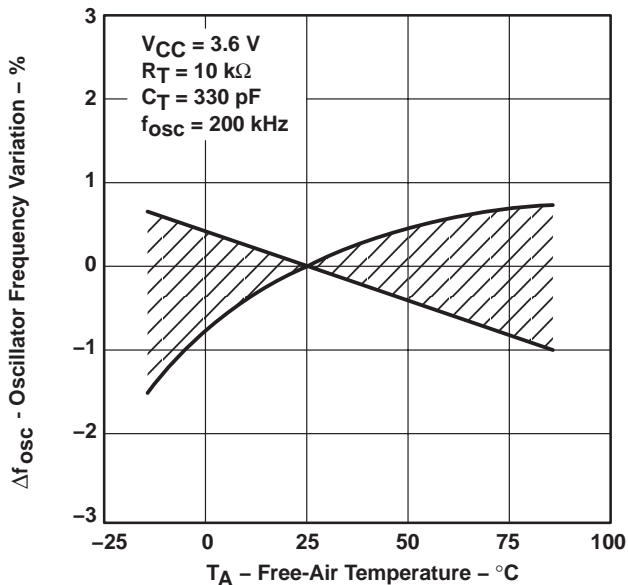

Figure 4

TRIANGLE WAVEFORM SWING VOLTAGE  
vs  
TIMING CAPACITANCE

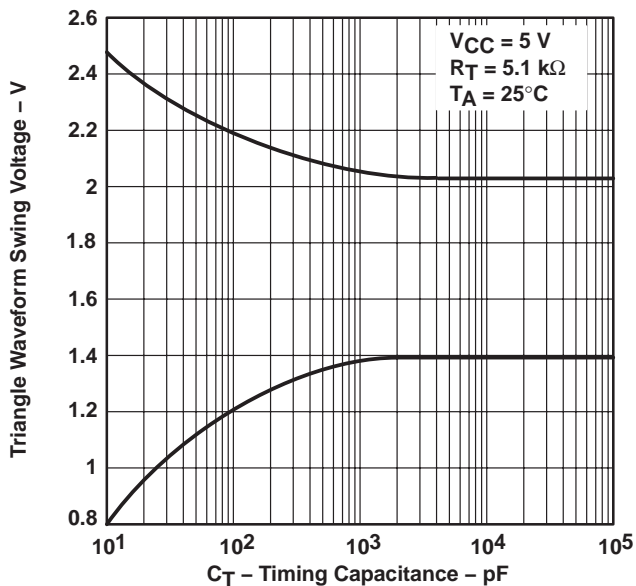

Figure 5

TRIANGLE WAVEFORM PERIOD  
vs  
TIMING CAPACITANCE

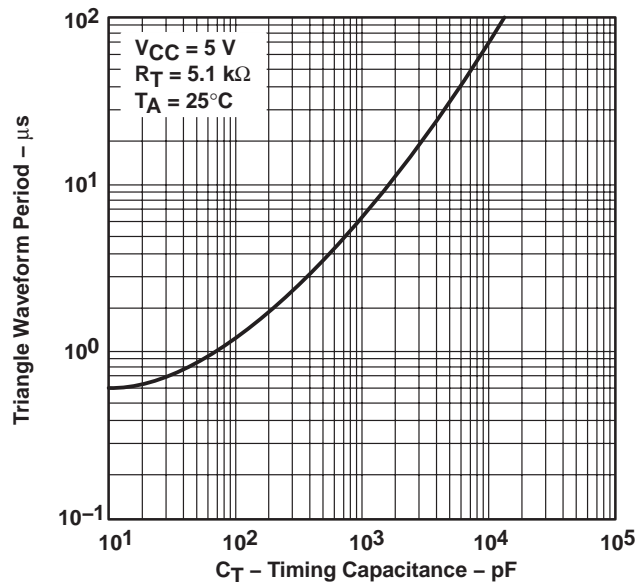
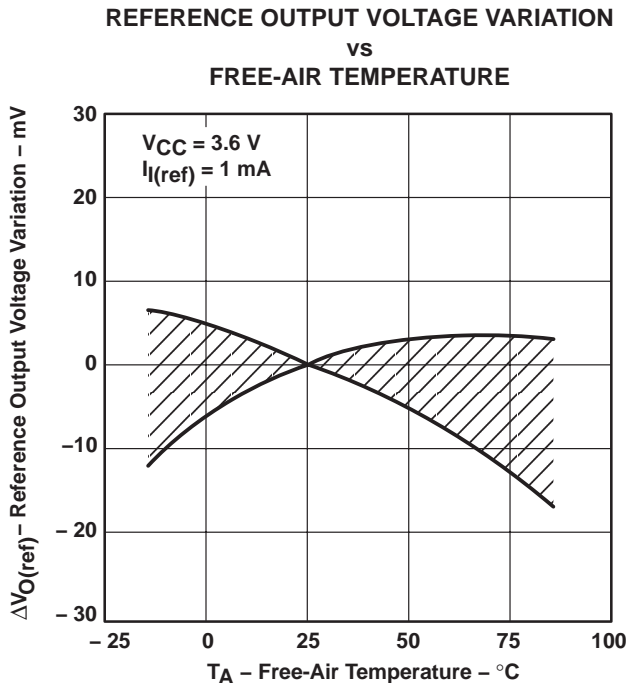

Figure 6



**TYPICAL CHARACTERISTICS**



**Figure 7**

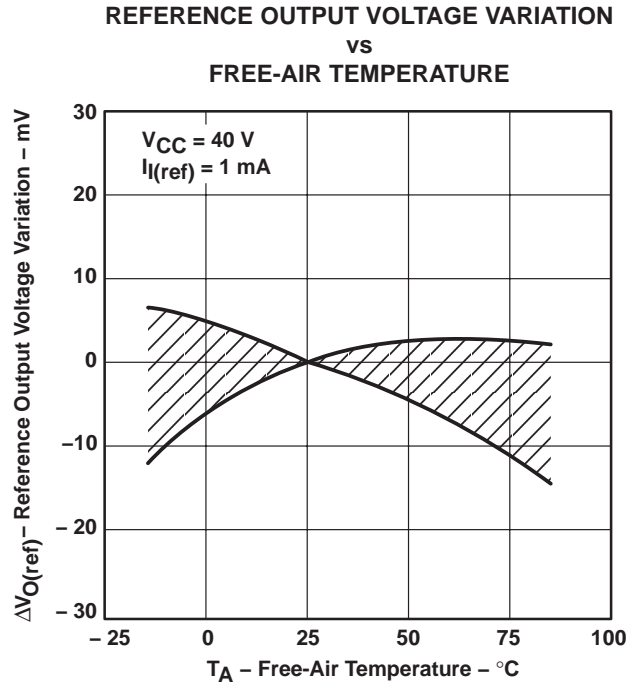

**Figure 8**

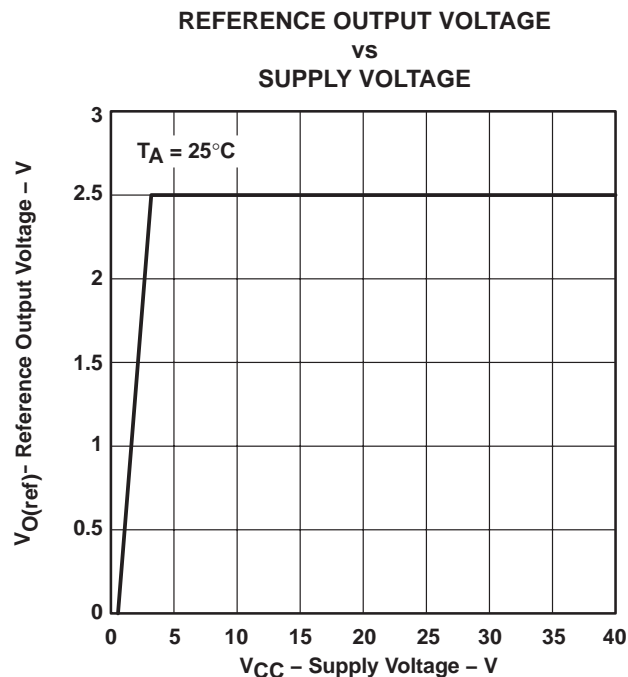

**Figure 9**

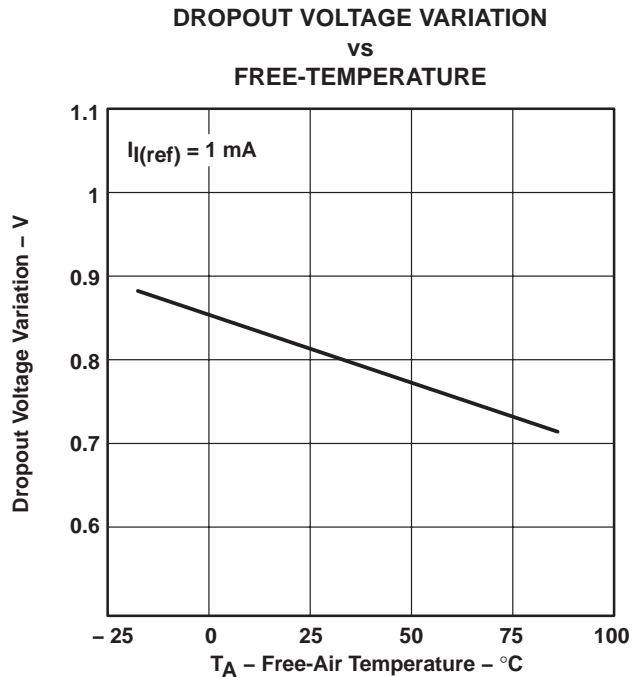

**Figure 10**

# TL1451A-Q1 DUAL PULSE-WIDTH-MODULATION CONTROL CIRCUITS

SGLS304A – JUNE 2005 – REVISED JUNE 2008

## TYPICAL CHARACTERISTICS

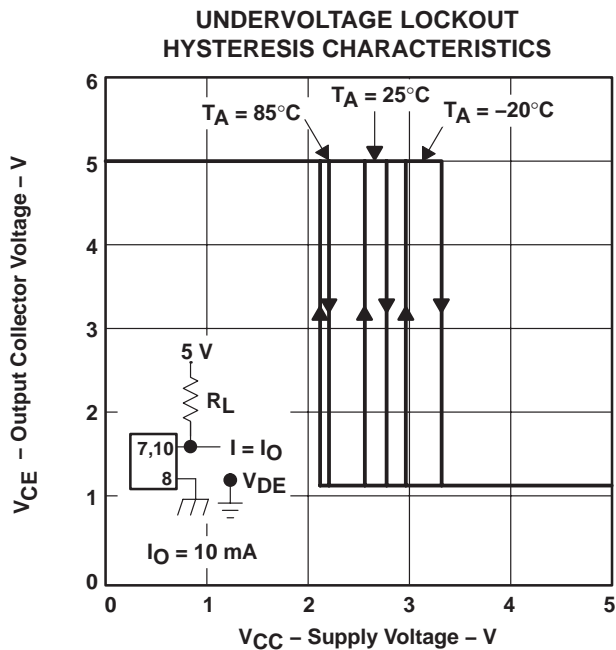

Figure 11

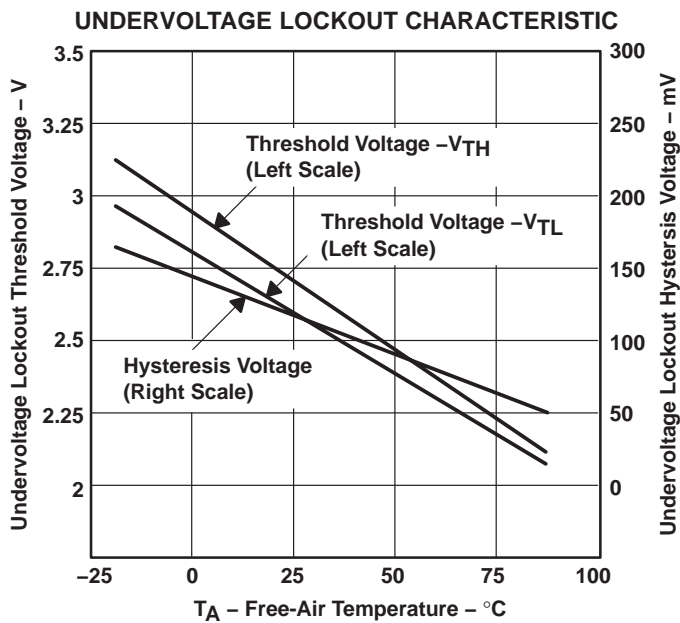

Figure 12

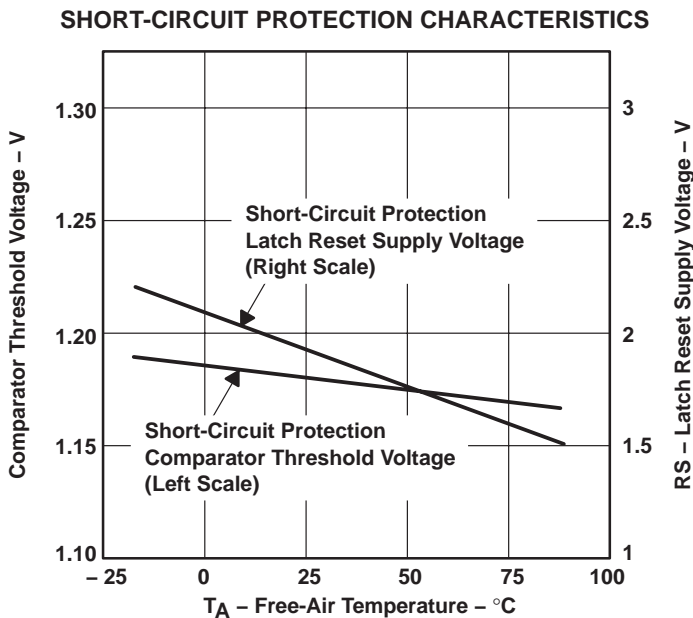
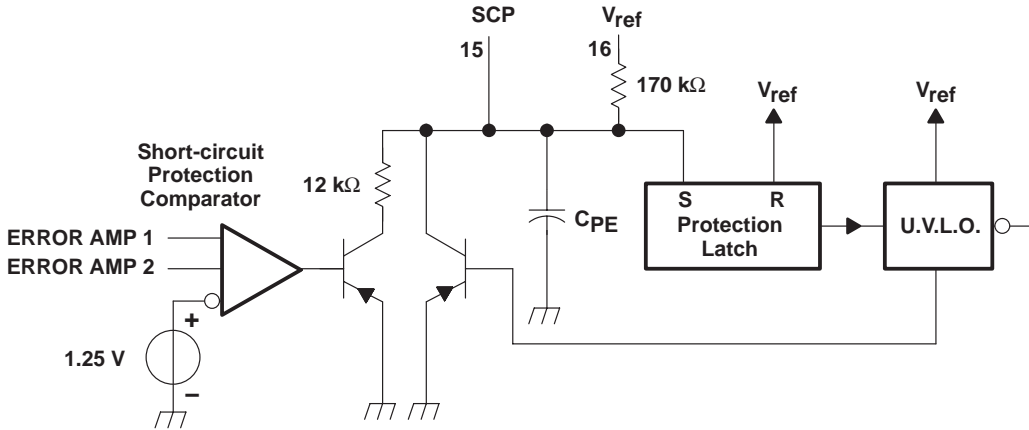
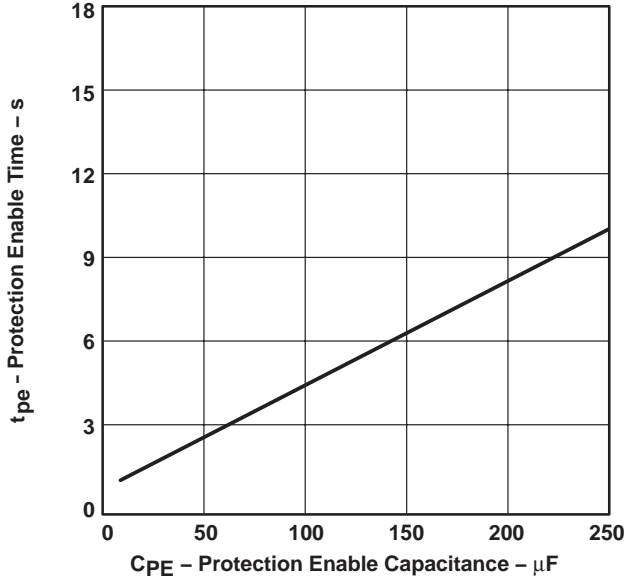

Figure 13

**TYPICAL CHARACTERISTICS**

**PROTECTION ENABLE TIME  
vs  
PROTECTION ENABLE CAPACITANCE**



**Figure 14**

# TL1451A-Q1

## DUAL PULSE-WIDTH-MODULATION CONTROL CIRCUITS

SGLS304A – JUNE 2005 – REVISED JUNE 2008

### TYPICAL CHARACTERISTICS

ERROR AMP MAXIMUM OUTPUT VOLTAGE SWING  
vs  
FREQUENCY

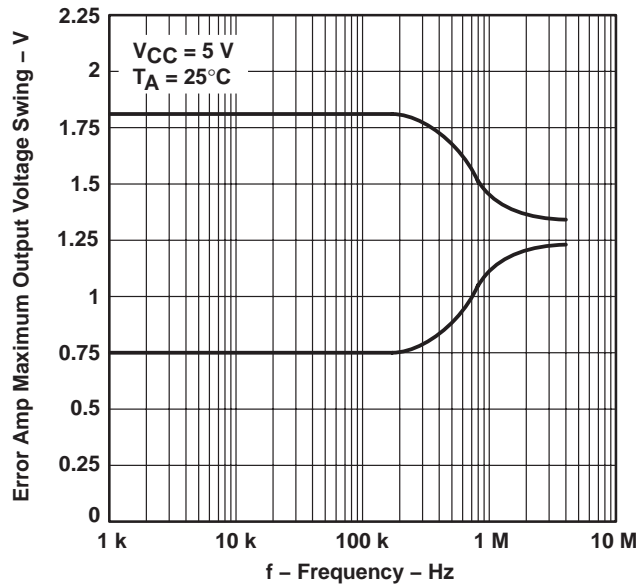

Figure 15

OPEN-LOOP VOLTAGE AMPLIFICATION  
vs  
FREQUENCY

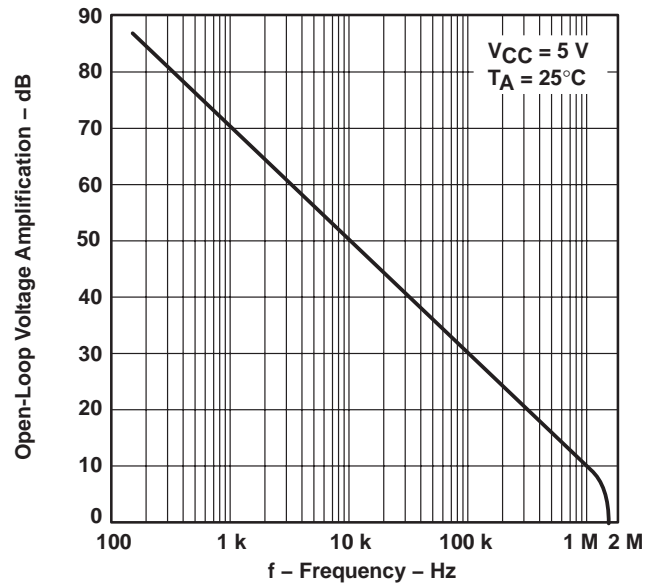

Figure 16

GAIN (AMPLIFIER IN  
UNITY-GAIN CONFIGURATION)  
vs  
FREQUENCY

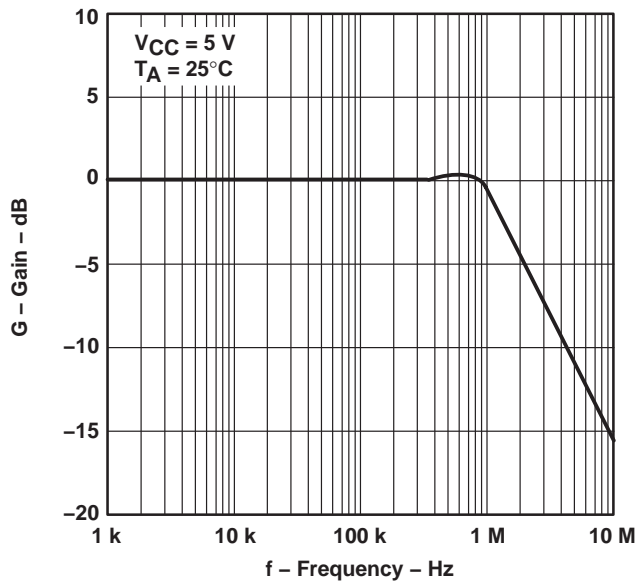
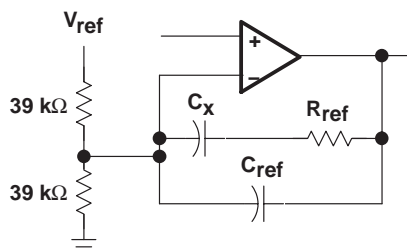
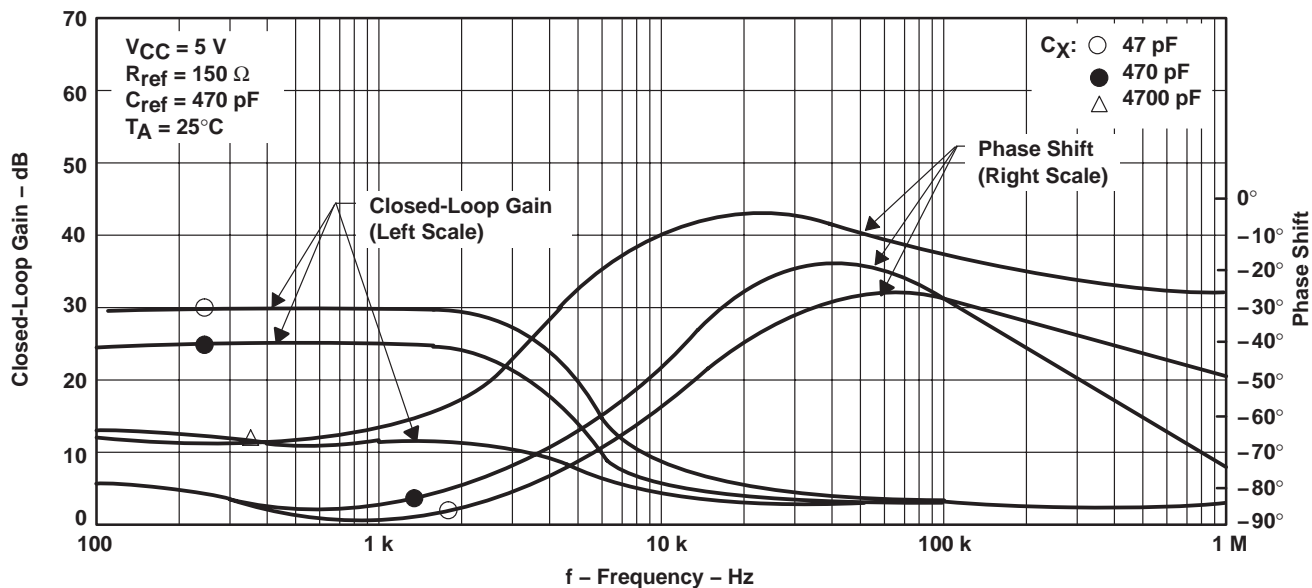

Figure 17

## TYPICAL CHARACTERISTICS

### CLOSED-LOOP GAIN AND PHASE SHIFT vs FREQUENCY



Test Circuit

Figure 18

# TL1451A-Q1 DUAL PULSE-WIDTH-MODULATION CONTROL CIRCUITS

SGLS304A – JUNE 2005 – REVISED JUNE 2008

## TYPICAL CHARACTERISTICS

### CLOSED-LOOP GAIN AND PHASE SHIFT vs FREQUENCY

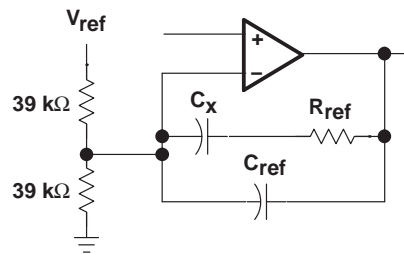
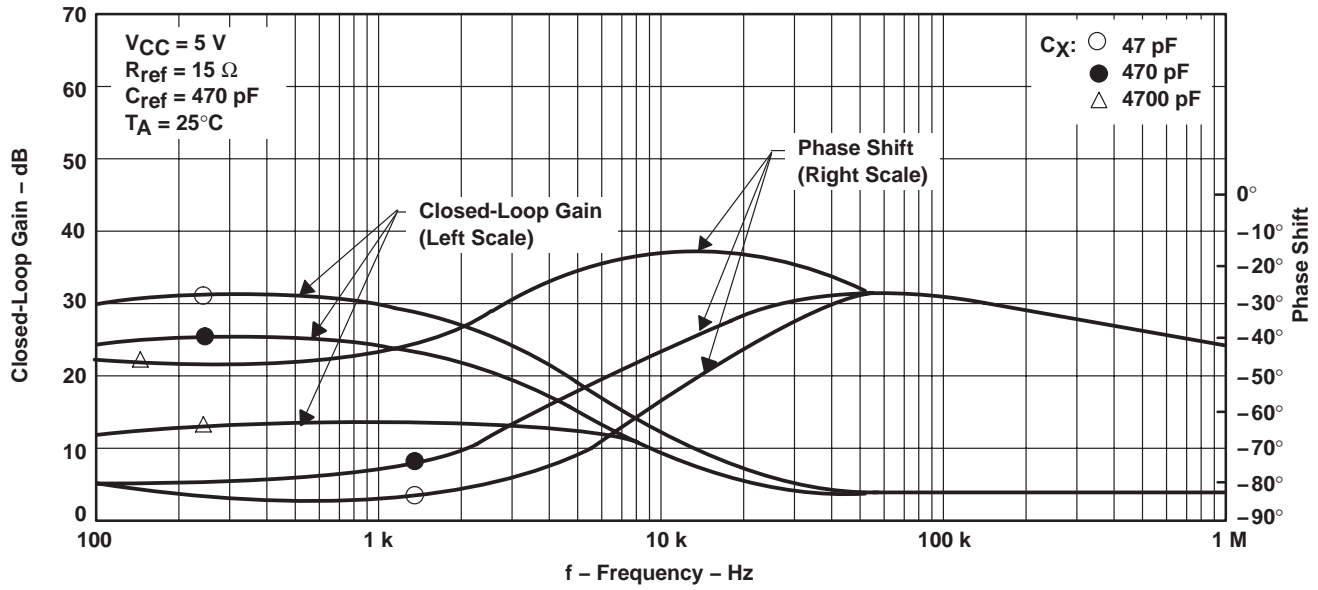

Test Circuit

Figure 19

**TYPICAL CHARACTERISTICS**

**CLOSED-LOOP GAIN AND PHASE SHIFT  
 VS  
 FREQUENCY**

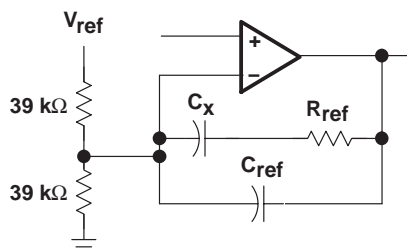
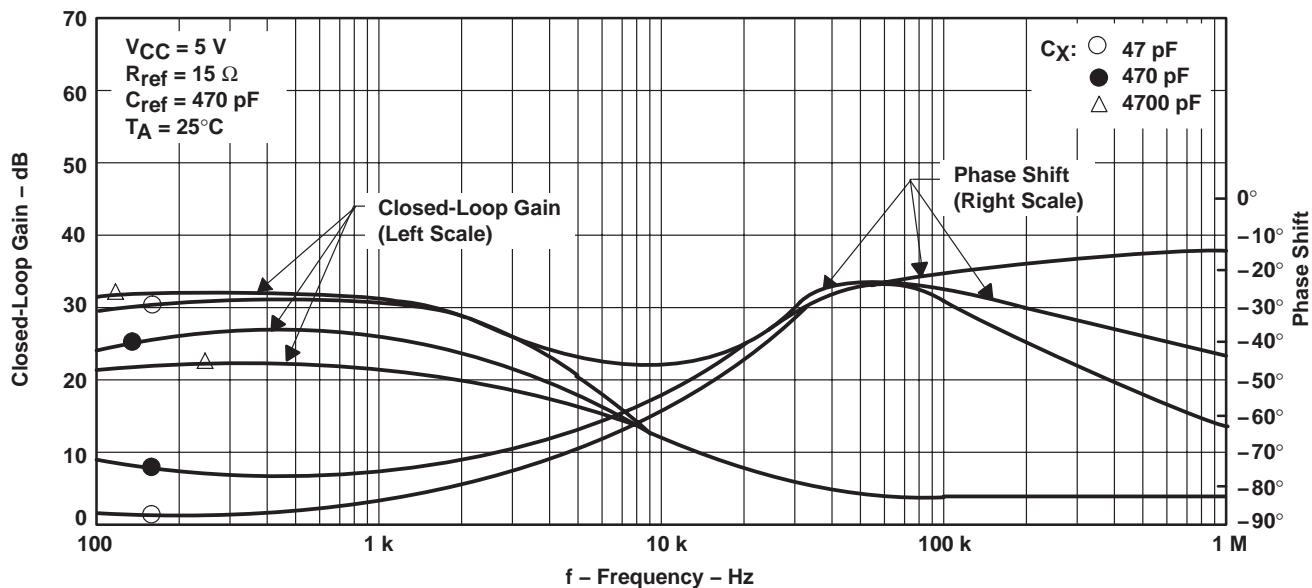

Test Circuit

Figure 20

# TL1451A-Q1

## DUAL PULSE-WIDTH-MODULATION CONTROL CIRCUITS

SGLS304A – JUNE 2005 – REVISED JUNE 2008

### TYPICAL CHARACTERISTICS

#### CLOSED-LOOP GAIN AND PHASE SHIFT vs FREQUENCY

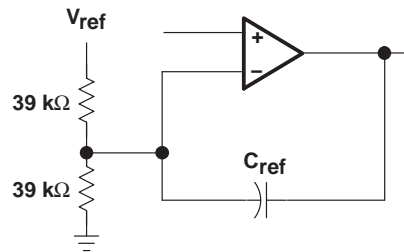
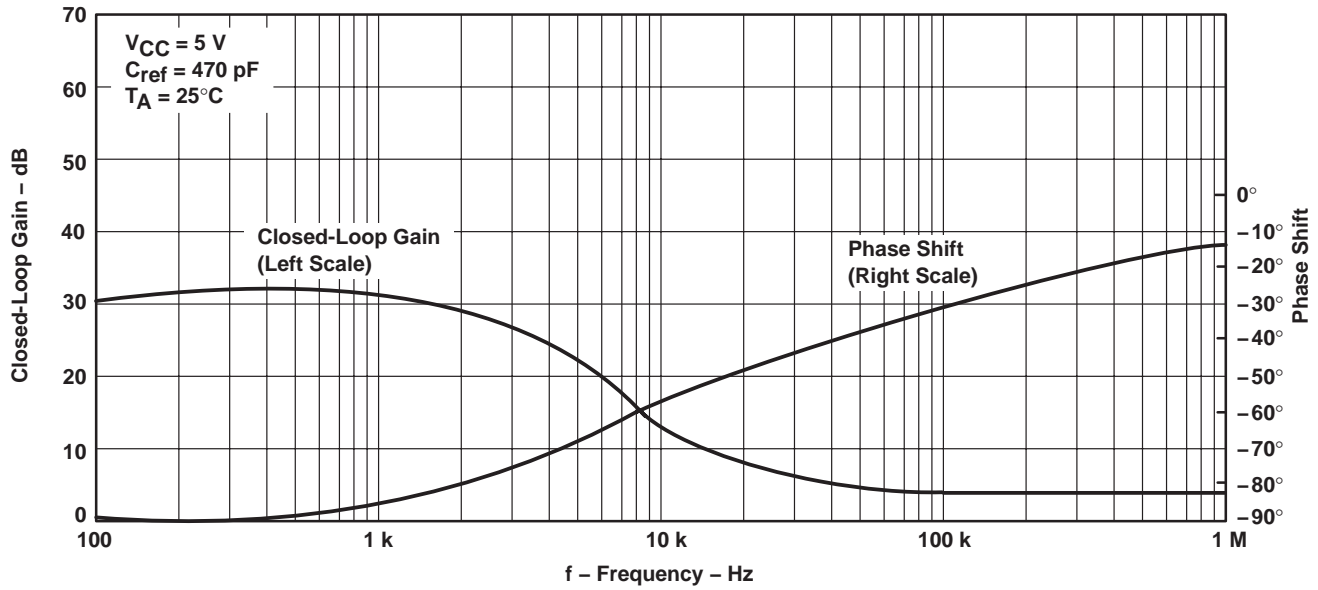

Test Circuit

Figure 21



**TYPICAL CHARACTERISTICS**

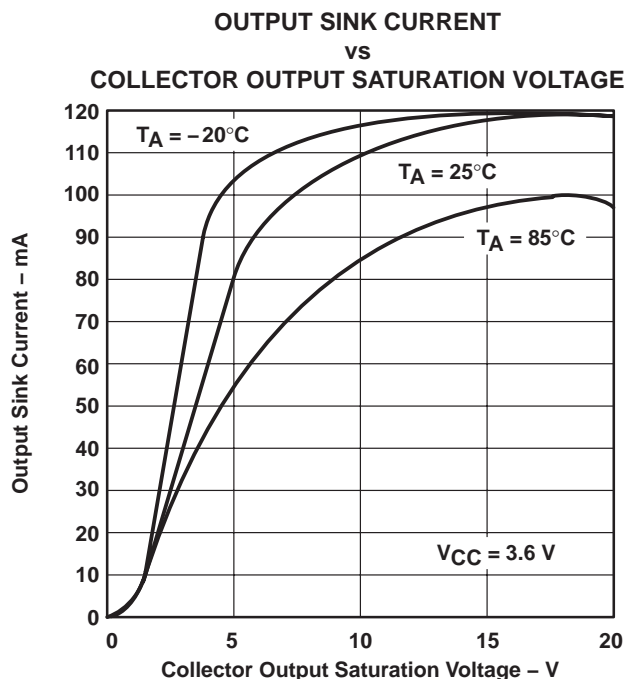
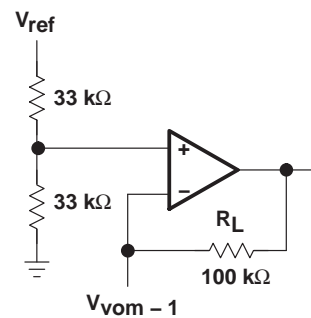
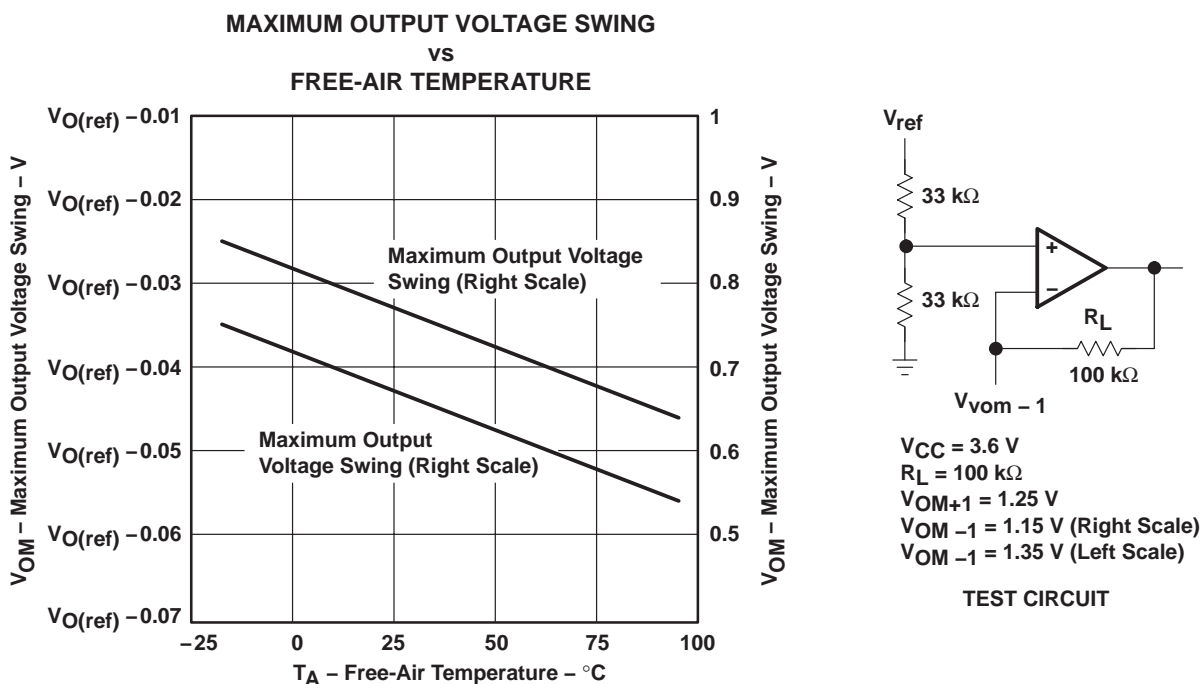

Figure 22



$V_{CC} = 3.6$  V  
 $R_L = 100$  kΩ  
 $V_{OM+1} = 1.25$  V  
 $V_{OM-1} = 1.15$  V (Right Scale)  
 $V_{OM-1} = 1.35$  V (Left Scale)

TEST CIRCUIT

Figure 23

# TL1451A-Q1

## DUAL PULSE-WIDTH-MODULATION CONTROL CIRCUITS

SGLS304A – JUNE 2005 – REVISED JUNE 2008

### TYPICAL CHARACTERISTICS

OUTPUT TRANSISTOR ON DUTY CYCLE  
vs  
DEAD-TIME INPUT VOLTAGE

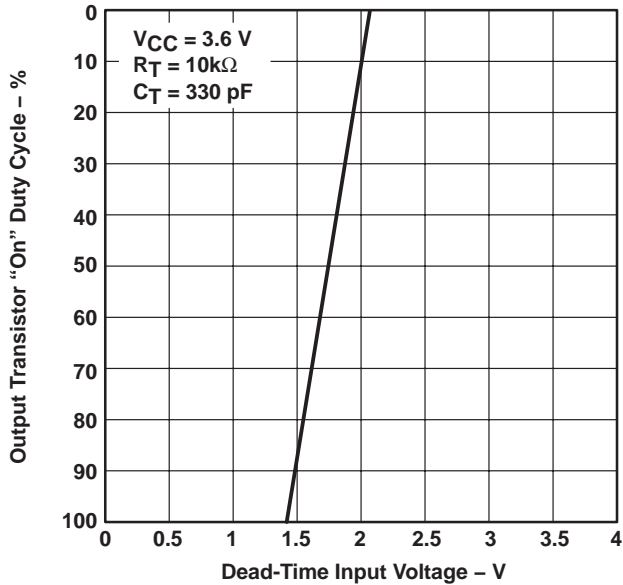

Figure 24

STANDBY CURRENT  
vs  
SUPPLY VOLTAGE

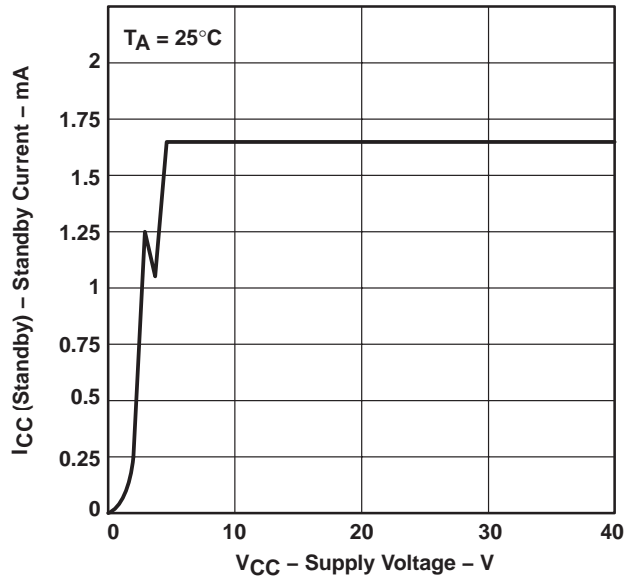

Figure 25

STANDBY CURRENT  
vs  
FREE-AIR TEMPERATURE

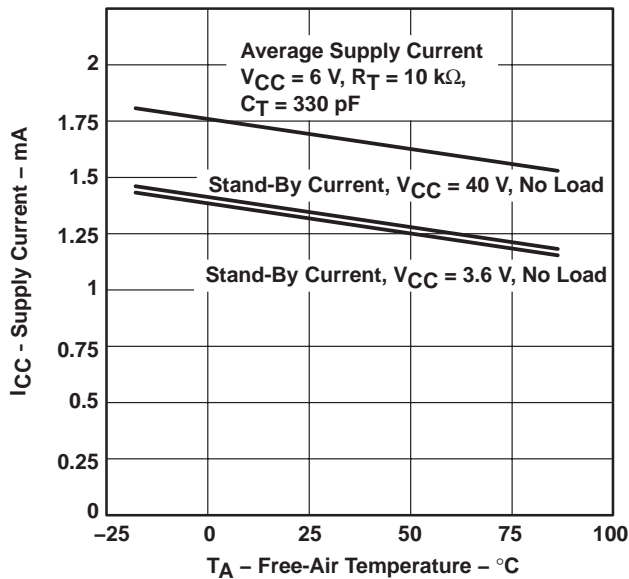

Figure 26

MAXIMUM CONTINUOUS POWER DISSIPATION  
vs  
FREE-AIR TEMPERATURE

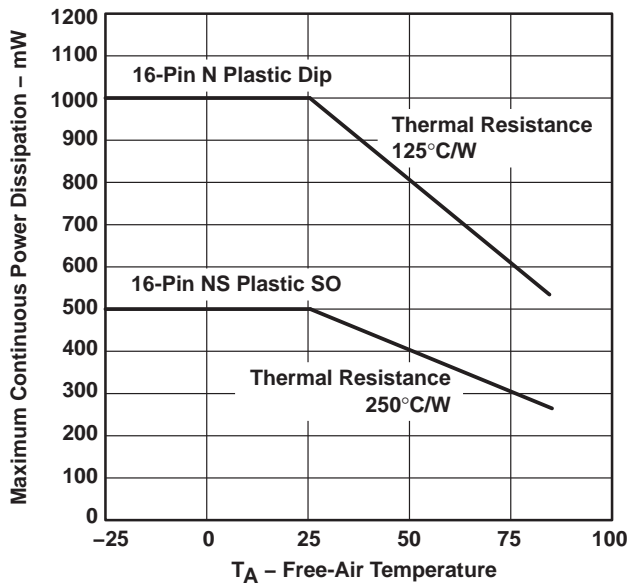
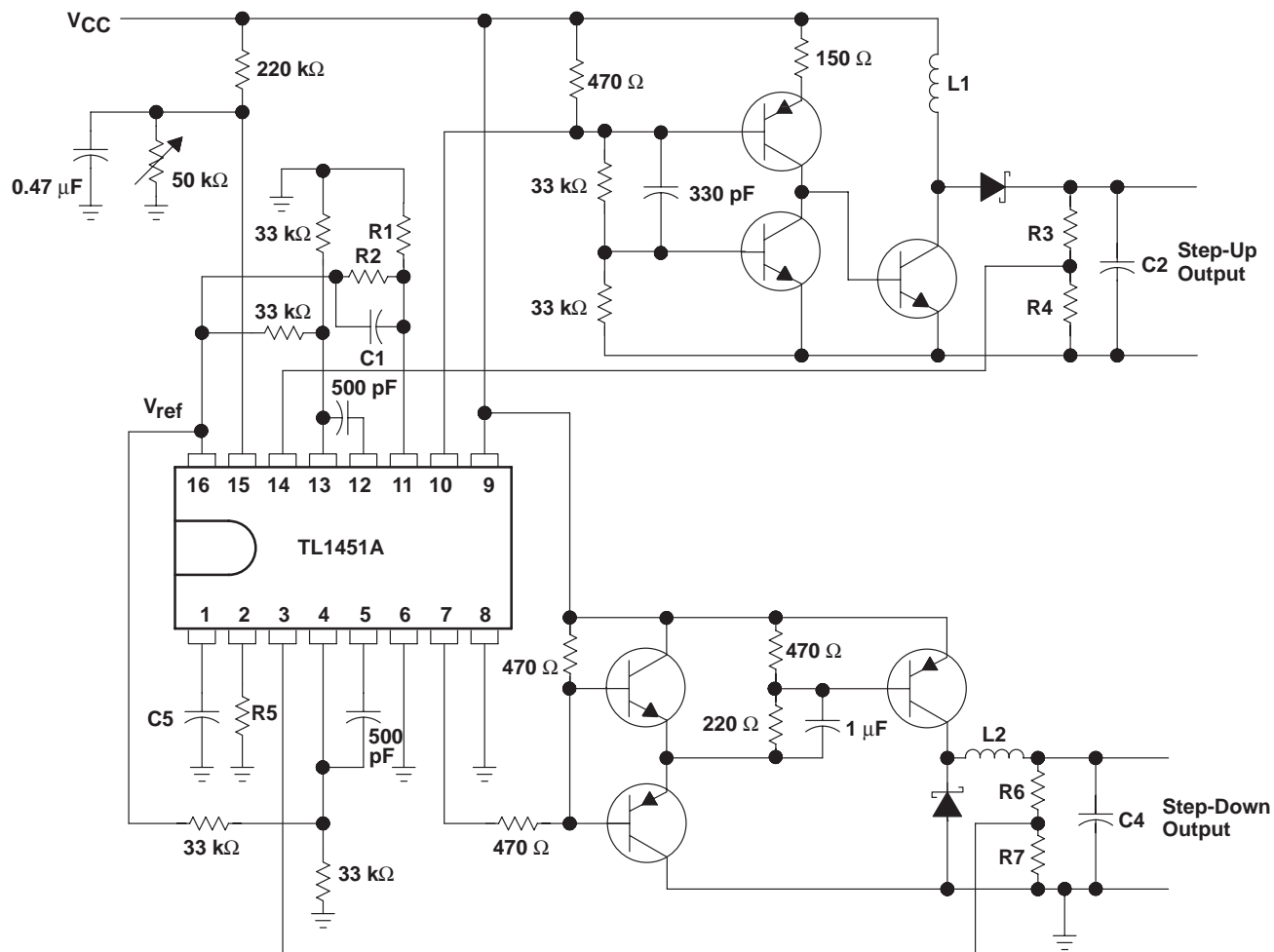

Figure 27

## APPLICATION INFORMATION



NOTE A: Values for R1 through R7, C1 through C4, and L1 and L2 depend upon individual application.

**Figure 28. High-Speed Dual Switching Regulator**

**PACKAGING INFORMATION**

Orderable Device	Status (1)	Package Type	Package Drawing	Pins	Package Qty	Eco Plan (2)	Lead finish/ Ball material (6)	MSL Peak Temp (3)	Op Temp (°C)	Device Marking (4/5)	Samples
TL1451AQPWRG4Q1	ACTIVE	TSSOP	PW	16	2000	RoHS & Green	NIPDAU	Level-1-260C-UNLIM	-40 to 125	1451AQ	<a href="#">Samples</a>
TL1451AQPWRQ1	ACTIVE	TSSOP	PW	16	2000	RoHS & Green	NIPDAU	Level-1-260C-UNLIM	-40 to 125	1451AQ	<a href="#">Samples</a>

(1) The marketing status values are defined as follows:

**ACTIVE:** Product device recommended for new designs.

**LIFEBUY:** TI has announced that the device will be discontinued, and a lifetime-buy period is in effect.

**NRND:** Not recommended for new designs. Device is in production to support existing customers, but TI does not recommend using this part in a new design.

**PREVIEW:** Device has been announced but is not in production. Samples may or may not be available.

**OBSOLETE:** TI has discontinued the production of the device.

(2) **RoHS:** TI defines "RoHS" to mean semiconductor products that are compliant with the current EU RoHS requirements for all 10 RoHS substances, including the requirement that RoHS substance do not exceed 0.1% by weight in homogeneous materials. Where designed to be soldered at high temperatures, "RoHS" products are suitable for use in specified lead-free processes. TI may reference these types of products as "Pb-Free".

**RoHS Exempt:** TI defines "RoHS Exempt" to mean products that contain lead but are compliant with EU RoHS pursuant to a specific EU RoHS exemption.

**Green:** TI defines "Green" to mean the content of Chlorine (Cl) and Bromine (Br) based flame retardants meet JS709B low halogen requirements of <=1000ppm threshold. Antimony trioxide based flame retardants must also meet the <=1000ppm threshold requirement.

(3) MSL, Peak Temp. - The Moisture Sensitivity Level rating according to the JEDEC industry standard classifications, and peak solder temperature.

(4) There may be additional marking, which relates to the logo, the lot trace code information, or the environmental category on the device.

(5) Multiple Device Markings will be inside parentheses. Only one Device Marking contained in parentheses and separated by a "~" will appear on a device. If a line is indented then it is a continuation of the previous line and the two combined represent the entire Device Marking for that device.

(6) Lead finish/Ball material - Orderable Devices may have multiple material finish options. Finish options are separated by a vertical ruled line. Lead finish/Ball material values may wrap to two lines if the finish value exceeds the maximum column width.

**Important Information and Disclaimer:**The information provided on this page represents TI's knowledge and belief as of the date that it is provided. TI bases its knowledge and belief on information provided by third parties, and makes no representation or warranty as to the accuracy of such information. Efforts are underway to better integrate information from third parties. TI has taken and continues to take reasonable steps to provide representative and accurate information but may not have conducted destructive testing or chemical analysis on incoming materials and chemicals. TI and TI suppliers consider certain information to be proprietary, and thus CAS numbers and other limited information may not be available for release.

In no event shall TI's liability arising out of such information exceed the total purchase price of the TI part(s) at issue in this document sold by TI to Customer on an annual basis.

**OTHER QUALIFIED VERSIONS OF TL1451A-Q1 :**

- Catalog: [TL1451A](#)
- Enhanced Product: [TL1451A-EP](#)

## NOTE: Qualified Version Definitions:

- Catalog - TI's standard catalog product
- Enhanced Product - Supports Defense, Aerospace and Medical Applications

**TAPE AND REEL INFORMATION**

**QUADRANT ASSIGNMENTS FOR PIN 1 ORIENTATION IN TAPE**

\*All dimensions are nominal

Device	Package Type	Package Drawing	Pins	SPQ	Reel Diameter (mm)	Reel Width W1 (mm)	A0 (mm)	B0 (mm)	K0 (mm)	P1 (mm)	W (mm)	Pin1 Quadrant
TL1451AQPWRG4Q1	TSSOP	PW	16	2000	330.0	12.4	6.9	5.6	1.6	8.0	12.0	Q1
TL1451AQPWRQ1	TSSOP	PW	16	2000	330.0	12.4	6.9	5.6	1.6	8.0	12.0	Q1

**TAPE AND REEL BOX DIMENSIONS**

\*All dimensions are nominal

Device	Package Type	Package Drawing	Pins	SPQ	Length (mm)	Width (mm)	Height (mm)
TL1451AQPWRG4Q1	TSSOP	PW	16	2000	853.0	449.0	35.0
TL1451AQPWRQ1	TSSOP	PW	16	2000	853.0	449.0	35.0



4220204/A 02/2017

NOTES:

1. All linear dimensions are in millimeters. Any dimensions in parenthesis are for reference only. Dimensioning and tolerancing per ASME Y14.5M.
2. This drawing is subject to change without notice.
3. This dimension does not include mold flash, protrusions, or gate burrs. Mold flash, protrusions, or gate burrs shall not exceed 0.15 mm per side.
4. This dimension does not include interlead flash. Interlead flash shall not exceed 0.25 mm per side.
5. Reference JEDEC registration MO-153.



# EXAMPLE BOARD LAYOUT

PW0016A

TSSOP - 1.2 mm max height

SMALL OUTLINE PACKAGE



LAND PATTERN EXAMPLE  
EXPOSED METAL SHOWN  
SCALE: 10X



4220204/A 02/2017

NOTES: (continued)

- 6. Publication IPC-7351 may have alternate designs.
- 7. Solder mask tolerances between and around signal pads can vary based on board fabrication site.

# EXAMPLE STENCIL DESIGN

PW0016A

TSSOP - 1.2 mm max height

SMALL OUTLINE PACKAGE



SOLDER PASTE EXAMPLE  
BASED ON 0.125 mm THICK STENCIL  
SCALE: 10X

4220204/A 02/2017

NOTES: (continued)

8. Laser cutting apertures with trapezoidal walls and rounded corners may offer better paste release. IPC-7525 may have alternate design recommendations.
9. Board assembly site may have different recommendations for stencil design.

## IMPORTANT NOTICE AND DISCLAIMER

TI PROVIDES TECHNICAL AND RELIABILITY DATA (INCLUDING DATASHEETS), DESIGN RESOURCES (INCLUDING REFERENCE DESIGNS), APPLICATION OR OTHER DESIGN ADVICE, WEB TOOLS, SAFETY INFORMATION, AND OTHER RESOURCES "AS IS" AND WITH ALL FAULTS, AND DISCLAIMS ALL WARRANTIES, EXPRESS AND IMPLIED, INCLUDING WITHOUT LIMITATION ANY IMPLIED WARRANTIES OF MERCHANTABILITY, FITNESS FOR A PARTICULAR PURPOSE OR NON-INFRINGEMENT OF THIRD PARTY INTELLECTUAL PROPERTY RIGHTS.

These resources are intended for skilled developers designing with TI products. You are solely responsible for (1) selecting the appropriate TI products for your application, (2) designing, validating and testing your application, and (3) ensuring your application meets applicable standards, and any other safety, security, or other requirements. These resources are subject to change without notice. TI grants you permission to use these resources only for development of an application that uses the TI products described in the resource. Other reproduction and display of these resources is prohibited. No license is granted to any other TI intellectual property right or to any third party intellectual property right. TI disclaims responsibility for, and you will fully indemnify TI and its representatives against, any claims, damages, costs, losses, and liabilities arising out of your use of these resources.

TI's products are provided subject to TI's Terms of Sale ([www.ti.com/legal/termsofsale.html](http://www.ti.com/legal/termsofsale.html)) or other applicable terms available either on [ti.com](http://ti.com) or provided in conjunction with such TI products. TI's provision of these resources does not expand or otherwise alter TI's applicable warranties or warranty disclaimers for TI products.

Mailing Address: Texas Instruments, Post Office Box 655303, Dallas, Texas 75265  
Copyright © 2020, Texas Instruments Incorporated