

## GaAs MMIC SP8T NON-REFLECTIVE POSITIVE CONTROL SWITCH, DC\* - 8 GHz



### Typical Applications

This switch is suitable for usage in DC - 8.0 GHz 50-Ohm or 75-Ohm systems:

- Broadband
- Fiber Optics
- Switched Filter Banks
- Wireless below 8 GHz

### Features

- Broadband Performance: DC - 8 GHz
- High Isolation: >30 dB@ 6 GHz
- Low Insertion Loss: 2.5 dB@ 6 GHz
- Integrated Positive Supply 3:8 TTL Decoder
- 4x4 mm SMT Package

### Functional Diagram

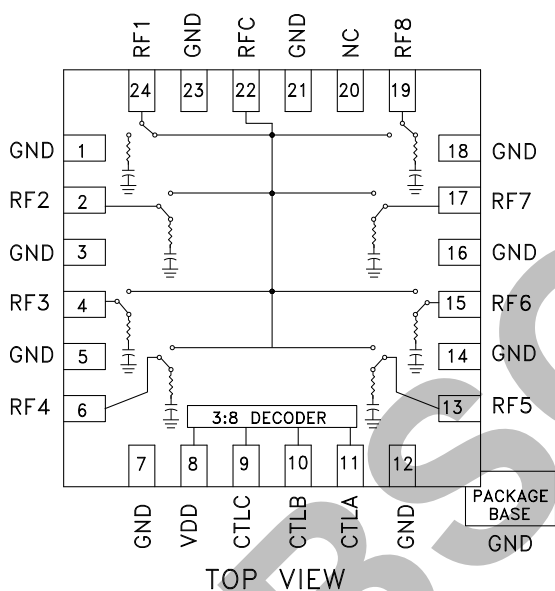

### General Description

The HMC321LP4 & HMC321LP4E are broadband non-reflective GaAs MESFET SP8T switches in low cost leadless surface mount packages. Covering DC to 8 GHz, this switch offers high isolation and low insertion loss. This switch also includes an on board binary decoder circuit which reduces the required logic control lines to three. The switch operates using a positive control voltage of 0/+5 volts, and requires a fixed bias of +5v. This switch is suitable for usage in 50-Ohm or 75-Ohm systems.

\* DC blocking capacitors are required at ports RFC and RF1, 2, 3, 4, 5, 6, 7, 8. Their value will determine the lowest transmission frequency.

### Electrical Specifications, $T_A = +25^\circ \text{C}$ , With 0/+5V Control, 50 Ohm System

| Parameter   | Frequency     | Min.                             | Typ. | Max. | Units |
|---|---------------|----------------------------------|------|------|-------|
| Insertion Loss  | DC - 2.0 GHz  |                                  | 2.3  | 2.7  | dB    |
|   | DC - 4.0 GHz  |                                  | 2.5  | 2.9  | dB    |
|   | DC - 8.0 GHz  |                                  | 2.7  | 3.1  | dB    |
| Isolation   | DC - 2.0 GHz  | 35                               | 40   |      | dB    |
|   | DC - 4.0 GHz  | 30                               | 35   |      | dB    |
|   | DC - 6.0 GHz  | 25                               | 30   |      | dB    |
|   | DC - 8.0 GHz  | 20                               | 25   |      | dB    |
| Return Loss   | "On State"    | DC - 4.0 GHz                     | 8    | 12   | dB    |
|   |               | DC - 8.0 GHz                     | 7    | 10   | dB    |
| Return Loss (RF1 - RF8)   | "Off State"   | 2.0 - 8.0 GHz                    | 7    | 12   | dB    |
| Input Power for 1 dB Compression  | 0.5 - 8.0 GHz | 19                               | 23   |      | dBm   |
| Input Third Order Intercept<br>(Two-tone Input Power = +7 dBm Each Tone, 1 MHz Spacing) | 0.5 - 8.0 GHz | 33                               | 40   |      | dBm   |
| Switching Characteristics   | DC - 8.0 GHz  | tRISE, tFALL (10/90% RF)         |      | 50   | ns    |
|   |               | tON, tOFF (50% CTL to 10/90% RF) |      | 150  | ns    |
|   |               |                                  |      |      |       |

Information furnished by Analog Devices is believed to be accurate and reliable. However, no responsibility is assumed by Analog Devices for its use, nor for any infringements of patents or other rights of third parties that may result from its use. Specifications subject to change without notice. No license is granted by implication or otherwise under any patent or patent rights of Analog Devices. Trademarks and registered trademarks are the property of their respective owners.

For price, delivery, and to place orders: Analog Devices, Inc., One Technology Way, P.O. Box 9106, Norwood, MA 02062-9106 Phone: 781-329-4700 • Order online at [www.analog.com](http://www.analog.com) Application Support: Phone: 1-800-ANALOG-D

## GaAs MMIC SP8T NON-REFLECTIVE POSITIVE CONTROL SWITCH, DC\* - 8 GHz



**Insertion Loss vs. Temperature**

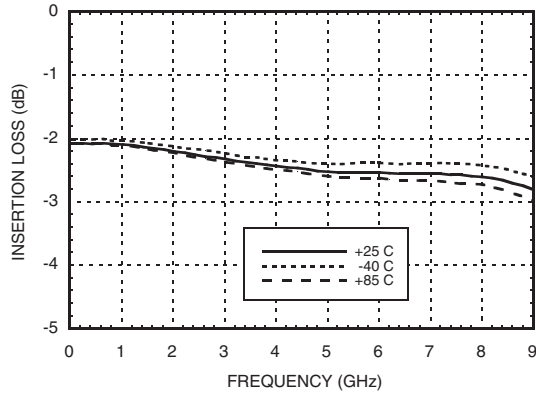

**Isolation**

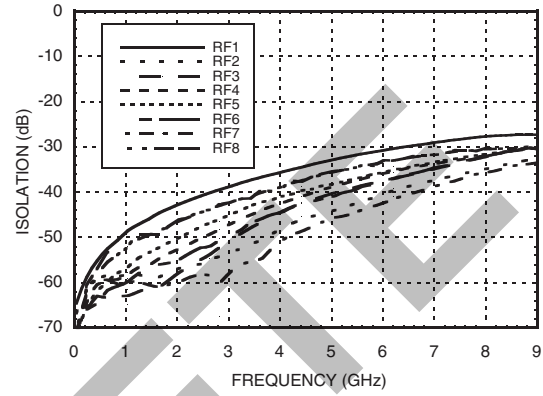

**Return Loss**

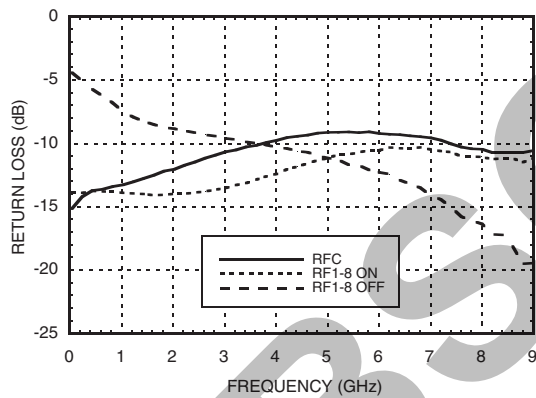

**0.1 and 1 dB Input Compression Point**

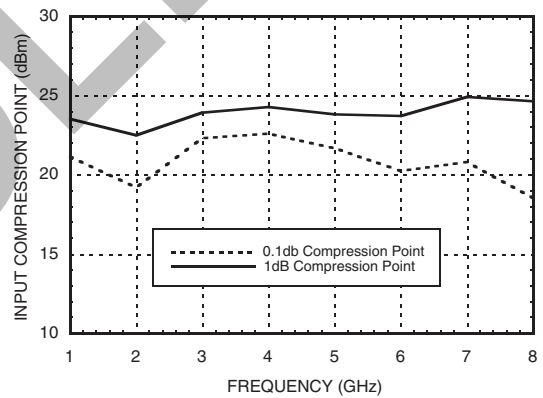

**Input Third Order Intercept Point**

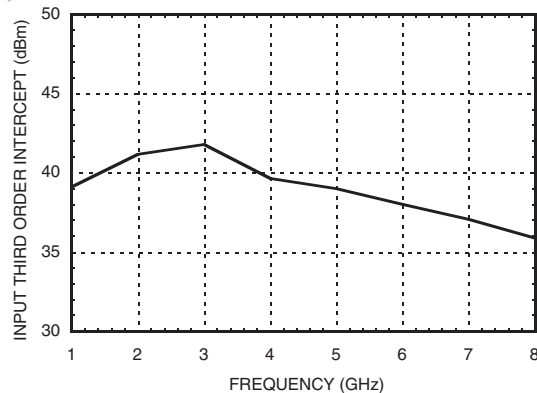

Information furnished by Analog Devices is believed to be accurate and reliable. However, no responsibility is assumed by Analog Devices for its use, nor for any infringements of patents or other rights of third parties that may result from its use. Specifications subject to change without notice. No license is granted by implication or otherwise under any patent or patent rights of Analog Devices. Trademarks and registered trademarks are the property of their respective owners.

For price, delivery, and to place orders: Analog Devices, Inc., One Technology Way, P.O. Box 9106, Norwood, MA 02062-9106 Phone: 781-329-4700 • Order online at [www.analog.com](http://www.analog.com) Application Support: Phone: 1-800-ANALOG-D

**GaAs MMIC SP8T NON-REFLECTIVE  
POSITIVE CONTROL SWITCH, DC\* - 8 GHz**

**Bias Voltage & Current**

| Vdd Range = +5.0 Vdc ± 10% |                 |                 |
|----------------------------|-----------------|-----------------|
| Vdd (Vdc)                  | Idd (Typ.) (mA) | Idd (Max.) (mA) |
| +5.0                       | 5.0             | 9.0             |

**Control Voltages**

| State | Bias Condition                   |
|-------|----------------------------------|
| Low   | 0 to +0.8 Vdc @ 5 uA Typical     |
| High  | +2.0 to +5.0 Vdc @ 25 uA Typical |

**Truth Table**

| Control Input |      |      | Signal Path State |
|---------------|------|------|-------------------|
| A             | B    | C    | RFCOM to:         |
| Low           | Low  | Low  | RF1               |
| High          | Low  | Low  | RF2               |
| Low           | High | Low  | RF3               |
| High          | High | Low  | RF4               |
| Low           | Low  | High | RF5               |
| High          | Low  | High | RF6               |
| Low           | High | High | RF7               |
| High          | High | High | RF8               |

*Note:*  
DC blocking capacitors are required at ports RFC and RF1, 2, 3, 4, 5, 6, 7, 8. Their value will determine the lowest transmission frequency.

## GaAs MMIC SP8T NON-REFLECTIVE POSITIVE CONTROL SWITCH, DC\* - 8 GHz



### Absolute Maximum Ratings

|                                   |                       |
|-----------------------------------|-----------------------|
| Bias Voltage Range (Port Vdd)     | +7.0 Vdc              |
| Control Voltage Range (A, B, & C) | -0.5V to Vdd +1.0 Vdc |
| Storage Temperature               | -65 to +150 °C        |
| Operating Temperature             | -40 to +85 °C         |
| Maximum Input Power Vdd = +5V     | +26 dBm               |
| ESD Sensitivity (HBM)             | Class 1A              |



ELECTROSTATIC SENSITIVE DEVICE  
OBSERVE HANDLING PRECAUTIONS

### Outline Drawing

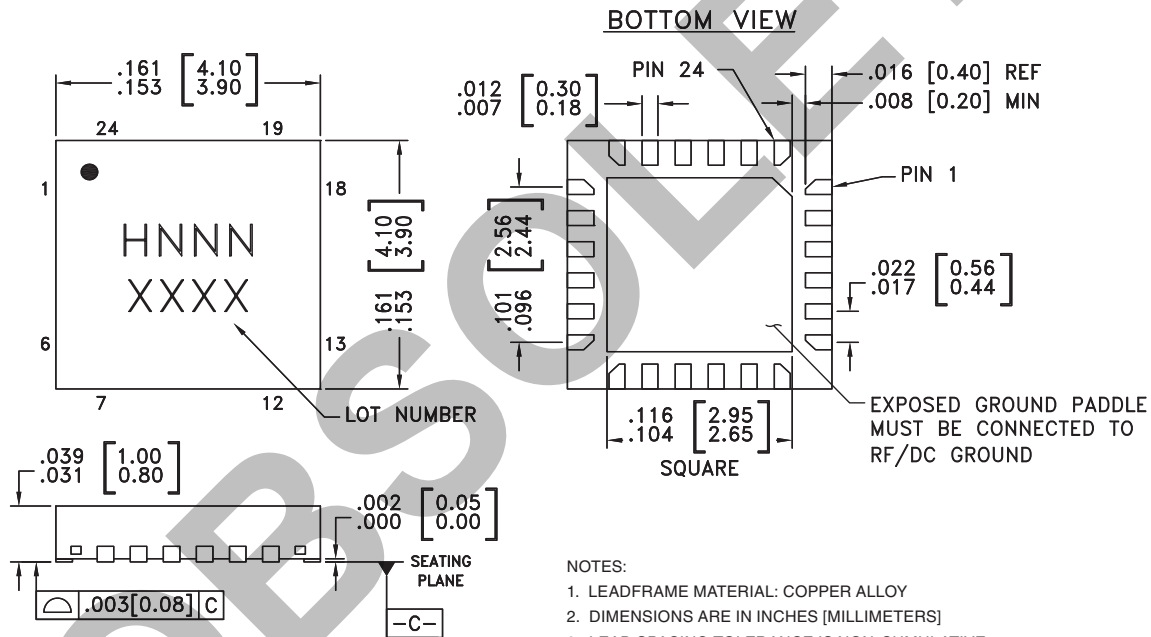

NOTES:

- LEADFRAME MATERIAL: COPPER ALLOY
- DIMENSIONS ARE IN INCHES [MILLIMETERS]
- LEAD SPACING TOLERANCE IS NON-CUMULATIVE.
- PAD BURR LENGTH SHALL BE 0.15mm MAXIMUM.  
PAD BURR HEIGHT SHALL BE 0.05mm MAXIMUM.
- PACKAGE WARP SHALL NOT EXCEED 0.05mm.
- ALL GROUND LEADS AND GROUND PADDLE MUST BE SOLDERED TO PCB RF GROUND.
- REFER TO HITTITE APPLICATION NOTE FOR SUGGESTED LAND PATTERN.

### Package Information

| Part Number | Package Body Material                              | Lead Finish   | MSL Rating          | Package Marking <sup>[3]</sup> |
|-------------|--|---------------|---------------------|--------------------------------|
| HMC321LP4   | Low Stress Injection Molded Plastic                | Sn/Pb Solder  | MSL1 <sup>[1]</sup> | H321<br>XXXX                   |
| HMC321LP4E  | RoHS-compliant Low Stress Injection Molded Plastic | 100% matte Sn | MSL1 <sup>[2]</sup> | H321<br>XXXX                   |

[1] Max peak reflow temperature of 235 °C

[2] Max peak reflow temperature of 260 °C

[3] 4-Digit lot number XXXX

## GaAs MMIC SP8T NON-REFLECTIVE POSITIVE CONTROL SWITCH, DC\* - 8 GHz

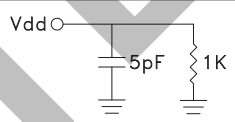
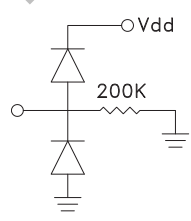

### Pin Descriptions

| Pin Number                         | Function        | Description   | Interface Schematic  |
|------------------------------------|-----------------|---|--|
| 1, 3, 5, 7, 12, 14, 16, 18, 21, 23 | GND             | Package bottom has exposed metal paddle that must also be connected to PCB RF ground. |   |
| 2, 4, 6, 13, 15, 17, 19, 22, 24    | RF1 - RF8 & RFC | This pin is DC coupled and matched to 50 Ohm. Blocking capacitors are required.       |  |
| 8                                  | VDD             | Supply Voltage +5V ± 10%  |   |
| 9                                  | CTL C           | See truth table and control voltage table.  |  |
| 10                                 | CTL B           | See truth table and control voltage table.  |  |
| 11                                 | CTL A           | See truth table and control voltage table.  |  |
| 20                                 | N/C             | This pin should be connected to PCB RF ground to maximize isolation.                  |  |

OBSOLETE

## GaAs MMIC SP8T NON-REFLECTIVE POSITIVE CONTROL SWITCH, DC\* - 8 GHz



### Evaluation PCB

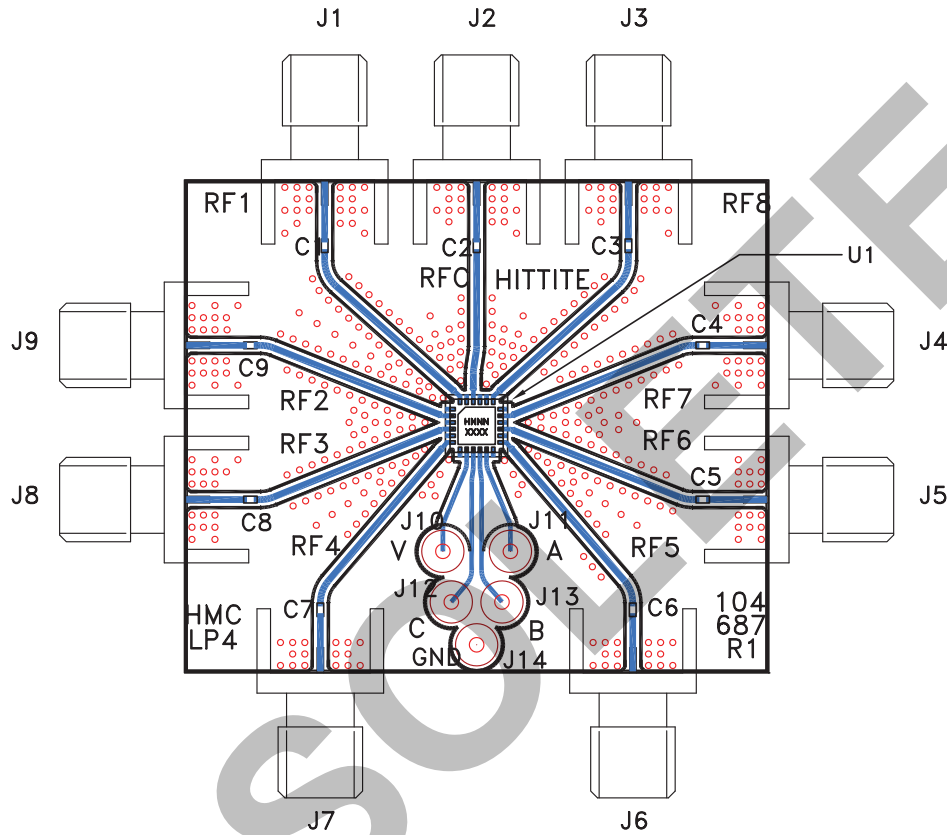

### List of Materials for Evaluation PCB 104769 [1]

| Item      | Description                         |
|-----------|-------------------------------------|
| J1 - J9   | PCB Mount SMA RF Connector          |
| J10 - J14 | DC Pin                              |
| C1 - C9   | 100 pF Capacitor, 0402 Pkg.         |
| U1        | HMC321LP4 / HMC321LP4E SP8T Switch  |
| PCB [2]   | 104687 Evaluation PCB 1.73" x 1.46" |

[1] Reference this number when ordering complete evaluation PCB

[2] Circuit Board Material: Rogers 4350

The circuit board used in the final application should be generated with proper RF circuit design techniques. Signal lines at the RF port should have 50 ohm impedance and the package ground leads and backside ground slug should be connected directly to the ground plane similar to that shown above. The evaluation circuit board shown above is available from Hittite Microwave Corporation upon request.