

USB-Compliant Single-Cell Li-Ion Switching Charger with USB-OTG Boost Regulator

FAN54015

Description

The FAN54015 combines a highly integrated switch-mode charger, to minimize single-cell Lithium-ion (Li-ion) charging time from a USB power source, and a boost regulator to power a USB peripheral from the battery.

The charging parameters and operating modes are programmable through an I²C Interface that operates up to 3.4 Mbps. The charger and boost regulator circuits switch at 3 MHz to minimize the size of external passive components.

The FAN54015 provides battery charging in three phases: conditioning, constant current and constant voltage.

To ensure USB compliance and minimize charging time, the input current limit can be changed through the I²C by the host processor. Charge termination is determined by a programmable minimum current level. A safety timer with reset control provides a safety backup for the I²C host. Charge status is reported to the host through the I²C port.

The integrated circuit (IC) automatically restarts the charge cycle when the battery falls below an internal threshold. If the input source is removed, the IC enters a high-impedance mode, preventing leakage from the battery to the input. Charge current is reduced when the die temperature reaches 120°C, protecting the device and PCB from damage.

The FAN54015 can operate as a boost regulator on command from the system. The boost regulator includes a soft-start that limits inrush current from the battery and uses the same external components used for charging the battery.

Features

- Fully Integrated, High-Efficiency Charger for Single-Cell Li-Ion and Li-Polymer Battery Packs
- Faster Charging than Linear
- Charge Voltage Accuracy: +0.5% at 25°C
+1% from 0 to 125°C
- +5% Input Current Regulation Accuracy
- +5% Charge Current Regulation Accuracy
- 20 V Absolute Maximum Input Voltage
- 6 V Maximum Input Operating Voltage
- 1.45 A Maximum Charge Rate
- Programmable through High-Speed I²C Interface (3.4 Mb/s) with Fast Mode Plus Compatibility
 - ◆ Input Current
 - ◆ Fast-Charge / Termination Current
 - ◆ Charger Voltage
 - ◆ Termination Enable



ON Semiconductor®

www.onsemi.com

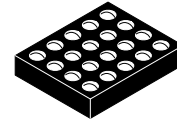

WLCSP20 1.96x1.87x0.586
CASE 567SL

MARKING DIAGRAM

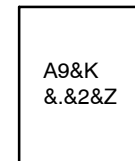

A9 = Specific Device Code
&K = 2-Digits Lot Run Traceability Code
&. = Pin One Dot
&2 = 2-Digit Date Code Format
&Z = Assembly Plant Code

ORDERING INFORMATION

See detailed ordering and shipping information on page 31 of this data sheet.

Features (continued)

- 3 MHz Synchronous Buck PWM Controller with Wide Duty Cycle Range
- Small Footprint 1 mH External Inductor
- Safety Timer with Reset Control
- 1.8 V Regulated Output from VBUS for Auxiliary Circuits
- Dynamic Input Voltage Control
- Low Reverse Leakage to Prevent Battery Drain to VBUS
- 5 V, 500 mA Boost Mode for USB OTG for 3.0 V to 4.5 V Battery Input
- Available in a 1.96 x 1.87 mm, 20-bump, 0.4 mm Pitch WLCSP Package
- These are Pb-Free Devices

Applications

- Cell Phones, Smart Phones, PDAs
- Tablet, Portable Media Players
- Gaming Device, Digital Cameras

FAN54015

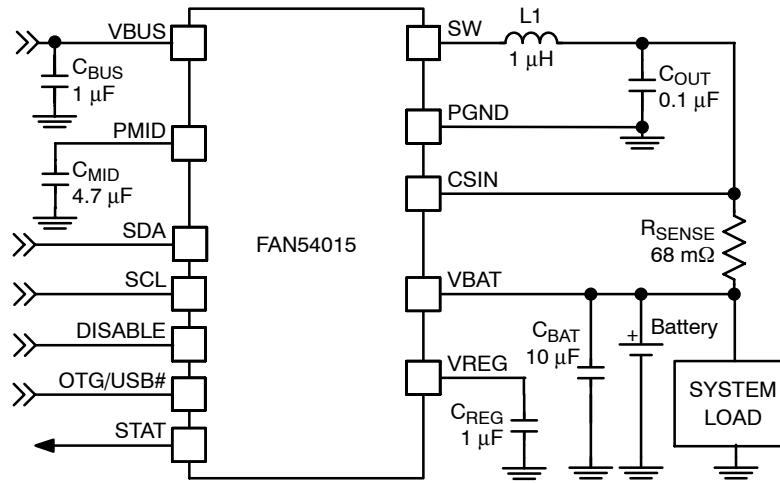

Figure 1. Typical Application

Table 1. FEATURE SUMMARY

Part Number	Slave Address	Automatic Charge	Special Charger (Note 1)	Safety Limits	Battery Absent Behavior	E2 Pin	VREG (E3 Pin)
FAN54015UCX	1101010	Yes	Yes	Yes	ON	DISABLE	1.8 V

1. A "special charger" is a current-limited charger that is not a USB compliant source.

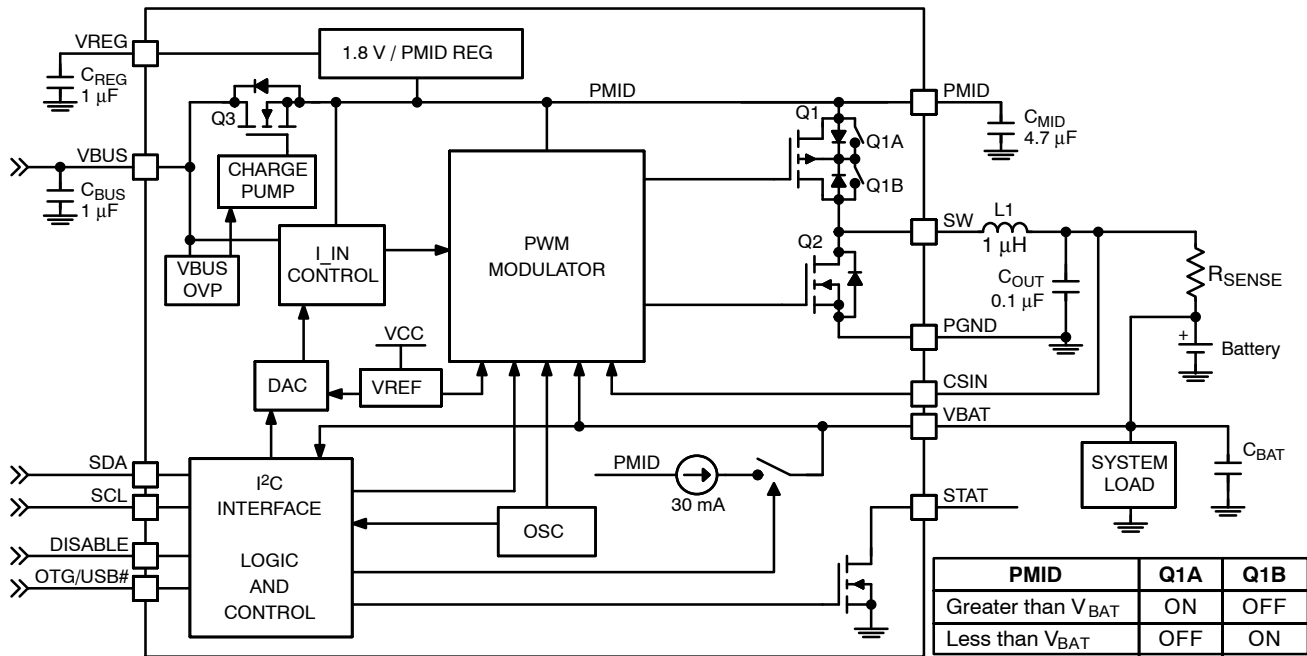

Figure 2. IC and System Block Diagram

FAN54015

Table 2. RECOMMENDED EXTERNAL COMPONENTS

Component	Description	Vendor	Parameter	Typ	Unit
L1	1 μ H \pm 20%, 1.6 A, DCR = 55 m Ω , 2520	Murata: LQM2HPN1R0	L	1.0	mH
	1 μ H \pm 30%, 1.4 A, DCR = 85 m Ω , 2016	Murata: LQM2MPN1R0			
CBAT	10 μ F, 20%, 6.3 V, X5R, 0603	Murata: GRM188R60J106M TDK: C1608X5R0J106M	C	10	mF
CMID	4.7 μ F, 10%, 6.3 V, X5R, 0603	Murata: GRM188R60J475K TDK: C1608X5R0J475K	C (Note 2)	4.7	mF
CBUS	1.0 μ F, 10%, 25 V, X5R, 0603	Murata GRM188R61E105K TDK:C1608X5R1E105M	C	1.0	mF

2. A 6.3 V rating is sufficient for C_{MID} because PMID is protected from over-voltage surges on VBUS by Q3 (Figure 2).



Figure 3. WLCSP-20 Pin Assignments

PIN DEFINITIONS

Pin #	Name	Description
A1, A2	VBUS	<i>Charger Input Voltage</i> and USB-OTG output voltage. Bypass with a 1 μ F capacitor to PGND.
A3	NC	<i>No Connect</i> . No external connection is made between this pin and the IC's internal circuitry.
A4	SCL	<i>I²C Interface Serial Clock</i> . This pin should not be left floating.
B1-B3	PMID	<i>Power Input Voltage</i> . Power input to the charger regulator, bypass point for the input current sense, and high-voltage input switch. Bypass with a minimum of 4.7 μ F, 6.3 V capacitor to PGND.
B4	SDA	<i>I²C Interface Serial Data</i> . This pin should not be left floating.
C1 - C3	SW	<i>Switching Node</i> . Connect to output inductor.
C4	STAT	<i>Status</i> . Open-drain output indicating charge status. The IC pulls this pin LOW when charging.
D1 - D3	PGND	<i>Power Ground</i> . Power return for gate drive and power transistors. The connection from this pin to the bottom of C _{MID} should be as short as possible.
D4	OTG	<i>On-The-Go</i> . Enables boost regulator in conjunction with OTG_EN and OTG_PL bits (see Table 16). On VBUS Power-On Reset (POR), this pin sets the input current limit for t _{15MIN} charging.
E1	CSIN	<i>Current-Sense Input</i> . Connect to the sense resistor in series with the battery. The IC uses this node to sense current into the battery. Bypass this pin with a 0.1 μ F capacitor to PGND.
E2	DISABLE	<i>Charge Disable</i> . If this pin is HIGH, charging is disabled. When LOW, charging is controlled by the I ² C registers. When this pin is HIGH, the 15-minute timer is reset. This pin does not affect the 32-second timer.
E3	VREG	<i>Regulator Output</i> . Connect to a 1 μ F capacitor to PGND. This pin can supply up to 2mA of DC load current. The output voltage is PMID, which is limited to 1.8 V.
E4	VBAT	<i>Battery Voltage</i> . Connect to the positive (+) terminal of the battery pack. Bypass with a 0.1 μ F capacitor to PGND if the battery is connected through long leads.

FAN54015

ABSOLUTE MAXIMUM RATINGS

Symbol	Parameter		Min	Max	Unit
V _{BUS}	VBUS Voltage	Continuous	-1.4	20.0	V
		Pulsed, 100 ms Maximum Non-Repetitive	-2.0		
V _{STAT}	STAT Voltage		-0.3	16.0	V
V _I	PMID Voltage		-	7.0	V
	SW, CSIN, VBAT, DISABLE Voltage		-0.3	7.0	
V _O	Voltage on Other Pins		-0.3	6.5 (Note 3)	V
$\frac{dV_{BUS}}{dt}$	Maximum V _{BUS} Slope above 5.5 V when Boost or Charger are Active		-	4	V/ μ s
ESD	Electrostatic Discharge Protection Level	Human Body Model per JESD22-A114	2000		V
		Charged Device Model per JESD22-C101	500		
T _J	Junction Temperature		-40	+150	°C
T _{STG}	Storage Temperature		-65	+150	°C
T _L	Lead Soldering Temperature, 10 Seconds		-	+260	°C

Stresses exceeding those listed in the Maximum Ratings table may damage the device. If any of these limits are exceeded, device functionality should not be assumed, damage may occur and reliability may be affected.

3. Lesser of 6.5 V or V_I + 0.3 V.

RECOMMENDED OPERATING CONDITIONS

Symbol	Parameter		Min	Max	Unit
V _{BUS}	Supply Voltage		4	6	V
V _{BAT(MAX)}	Maximum Battery Voltage when Boost enabled		-	4.5	V
$-\frac{dV_{BUS}}{dt}$	Negative VBUS Slew Rate during VBUS Short Circuit, C _{MID} ≤ 4.7 μ F (see VBUS Short While Charging)	T _A ≤ 60°C	-	4	V/ μ s
		T _A ≥ 60°C	-	2	
T _A	Ambient Temperature		-30	+85	°C
T _J	Junction Temperature (see Thermal Regulation and Protection section)		-30	+120	°C

Functional operation above the stresses listed in the Recommended Operating Ranges is not implied. Extended exposure to stresses beyond the Recommended Operating Ranges limits may affect device reliability.

THERMAL PROPERTIES

Symbol	Parameter	Value	Unit
θ_{JA}	Junction-to-Ambient Thermal Resistance	60	°C/W
θ_{JB}	Junction-to-PCB Thermal Resistance	20	°C/W

Junction-to-ambient thermal resistance is a function of application and board layout. This data is measured with four-layer 2s2p boards in accordance to JEDEC standard JESD51. Special attention must be paid not to exceed junction temperature T_{J(max)} at a given ambient temperature T_A. For measured data, see Table 11.

FAN54015

ELECTRICAL SPECIFICATIONS (Unless otherwise specified: according to the circuit of Figure 1; recommended operating temperature range for T_J and T_A ; $V_{BUS} = 5.0\text{ V}$; HZ_MODE ; $OPA_MODE = 0$; (Charge Mode); SCL , SDA , $OTG = 0$ or 1.8 V ; and typical values are for $T_J = 25^\circ\text{C}$)

Symbol	Parameter	Conditions	Min	Typ	Max	Unit
--------	-----------	------------	-----	-----	-----	------

POWER SUPPLIES

I_{VBUS}	VBUS Current	$V_{BUS} > V_{BUS(min)}$, PWM Switching	-	10	-	mA
		$V_{BUS} > V_{BUS(min)}$; PWM Enabled, Not Switching (Battery OVP Condition); I_{IN} Setting = 100 mA	-	2.5	-	mA
		$0^\circ\text{C} < T_J < 85^\circ\text{C}$, $HZ_MODE = 1$ $V_{BAT} < V_{LOWV}$, 32S Mode	-	63	90	μA
I_{LKG}	VBAT to VBUS Leakage Current	$0^\circ\text{C} < T_J < 85^\circ\text{C}$, $HZ_MODE = 1$, $V_{BAT} = 4.2\text{ V}$, $V_{BUS} = 0\text{ V}$	-	0.2	5.0	μA
I_{BAT}	Battery Discharge Current in High-Impedance Mode	$0^\circ\text{C} < T_J < 85^\circ\text{C}$, $HZ_MODE = 1$, $V_{BAT} = 4.2\text{ V}$	-	-	20	μA
		DISABLE = 1, $0^\circ\text{C} < T_J < 85^\circ\text{C}$, $V_{BAT} = 4.2\text{ V}$	-	-	10	

CHARGER VOLTAGE REGULATION

V_{OREG}	Charge Voltage Range		3.5	-	4.4	V
	Charge Voltage Accuracy	$T_A = 25^\circ\text{C}$	-0.5%	-	+0.5%	
		$T_J = 0$ to 125°C	-1%	-	+1%	

CHARGING CURRENT REGULATION

I_{OCHRG}	Output Charge Current Range	$V_{LOWV} < V_{BAT} < V_{OREG}$, $R_{SENSE} = 68\text{ m}\Omega$	550	-	1450	mA
	Charge Current Accuracy Across R_{SENSE}	$20\text{ mV} \leq V_{IREG} \leq 40\text{ mV}$	92	97	102	%
		$V_{IREG} > 40\text{ mV}$	94	97	100	%

WEAK BATTERY DETECTION

V_{LOWV}	Weak Battery Threshold Range		3.4	-	3.7	V
	Weak Battery Threshold Accuracy		-5	-	+5	%
	Weak Battery Deglitch Time	Rising Voltage	-	30	-	ms

LOGIC LEVELS: DISABLE, SDA, SCL, OTG

V_{IH}	High-Level Input Voltage		1.05	-	-	V
V_{IL}	Low-Level Input Voltage		-	-	0.4	V
I_{IN}	Input Bias Current	Input Tied to GND or V_{IN}	-	0.01	1.00	μA

CHARGE TERMINATION DETECTION

$I_{(TERM)}$	Termination Current Range	$V_{BAT} > V_{OREG} - V_{RCH}$, $R_{SENSE} = 68\text{ m}\Omega$	50	-	400	mA
	Termination Current Accuracy	$[V_{CSIN} - V_{BAT}]$ from 3 mV to 20 mV	-25	-	+25	%
		$[V_{CSIN} - V_{BAT}]$ from 20 mV to 40 mV	-5	-	+5	
	Termination Current Deglitch Time	2 mV Overdrive	-	30	-	ms

1.8 V LINEAR REGULATOR

V_{REG}	1.8 V Regulator Output	I_{REG} from 0 to 2 mA	1.7	1.8	1.9	V
-----------	------------------------	--------------------------	-----	-----	-----	---

INPUT POWER SOURCE DETECTION

$V_{IN(MIN)1}$	VBUS Input Voltage Rising	To Initiate and Pass VBUS Validation	-	4.29	4.42	V
$V_{IN(MIN)2}$	Minimum VBUS During Charge	During Charging	-	3.71	3.94	V
t_{VBUS_VALID}	VBUS Validation Time		-	30	-	ms

SPECIAL CHARGER (V_{BUS})

V_{SP}	Special Charger Setpoint Accuracy		-3	-	+3	%
----------	-----------------------------------	--	----	---	----	---

FAN54015

ELECTRICAL SPECIFICATIONS (Unless otherwise specified: according to the circuit of Figure 1; recommended operating temperature range for T_J and T_A ; $V_{BUS} = 5.0\text{ V}$; HZ_MODE ; $OPA_MODE = 0$; (Charge Mode); SCL , SDA , $OTG = 0$ or 1.8 V ; and typical values are for $T_J = 25^\circ\text{C}$) (continued)

Symbol	Parameter	Conditions	Min	Typ	Max	Unit
--------	-----------	------------	-----	-----	-----	------

INPUT CURRENT LIMIT

I_{INLIM}	Input Current Limit Threshold	I_{IN} Set to 100 mA	88	93	98	mA
		I_{IN} Set to 500 mA	450	475	500	

V_{REF} BIAS GENERATOR

V_{REF}	Bias Regulator Voltage	$V_{BUS} > V_{IN(MIN)}$ or $V_{BAT} > V_{BAT(MIN)}$	-	-	6.5	V
	Short-Circuit Current Limit		-	20	-	mA

BATTERY RECHARGE THRESHOLD

V_{RCH}	Recharge Threshold	Below $V_{(OREG)}$	100	120	150	mV
	Deglitch Time	V_{BAT} Falling Below V_{RCH} Threshold	-	130	-	ms

STAT OUTPUT

$V_{STAT(OL)}$	STAT Output Low	$I_{STAT} = 10\text{ mA}$	-	-	0.4	V
$I_{STAT(OH)}$	STAT High Leakage Current	$V_{STAT} = 5\text{ V}$	-	-	1	μA

BATTERY DETECTION

I_{DETECT}	Battery Detection Current before Charge Done (Sink Current) (Note 4)	Begins after Termination Detected and $V_{BAT} \leq V_{OREG} - V_{RCH}$	-	-0.80	-	mA
t_{DETECT}	Battery Detection Time			262		ms

SLEEP COMPARATOR

V_{SLP}	Sleep-Mode Entry Threshold, $V_{BUS} - V_{BAT}$	$2.3\text{ V} \leq V_{BAT} \leq V_{OREG}$; V_{BUS} Falling	0	0.04	0.10	V
t_{SLP_EXIT}	Deglitch Time for V_{BUS} Rising Above V_{BAT} by V_{SLP}	Rising Voltage	-	30	-	ms

POWER SWITCHES (see Figure 2)

$R_{DS(ON)}$	Q3 On Resistance (V_{BUS} to $PMID$)	$I_{N(LIMIT)} = 500\text{ mA}$	-	180	250	m Ω
	Q1 On Resistance ($PMID$ to SW)		-	130	225	
	Q2 On Resistance (SW to GND)		-	150	225	

CHARGER PWM MODULATOR

f_{SW}	Oscillator Frequency		2.7	3.0	3.3	MHz
D_{MAX}	Maximum Duty Cycle		-	-	100	%
D_{MIN}	Minimum Duty Cycle		-	0	-	%
I_{SYNC}	Synchronous to Non-Synchronous Current Cut-Off Threshold (Note 5)	Low-Side MOSFET (Q2) Cycle-by-Cycle Current Limit	-	140	-	mA

BOOST MODE OPERATION ($OPA_MODE = 1$, $HZ_MODE = 0$)

V_{BOOST}	Boost Output Voltage at V_{BUS}	$2.5\text{ V} < V_{BAT} < 4.5\text{ V}$, I_{LOAD} from 0 to 200 mA	4.80	5.07	5.17	V
		$3.0\text{ V} < V_{BAT} < 4.5\text{ V}$, I_{LOAD} from 0 to 500 mA	4.77	5.07	5.17	
$I_{BAT(BOOST)}$	Boost Mode Quiescent Current	PFM Mode, $V_{BAT} = 3.6\text{ V}$, $I_{OUT} = 0$	-	140	300	μA
$I_{LIMPK(BST)}$	Q2 Peak Current Limit		1272	1590	1908	mA
$UVLO_{BST}$	Minimum Battery Voltage for Boost Operation	While Boost Active	-	2.42	-	V
		To Start Boost Regulator	-	2.58	2.70	

V_{BUS} LOAD RESISTANCE

R_{VBUS}	V_{BUS} to $PGND$ Resistance	Normal Operation	-	1500	-	k Ω
		Charger Validation	-	100	-	Ω

FAN54015

ELECTRICAL SPECIFICATIONS (Unless otherwise specified: according to the circuit of Figure 1; recommended operating temperature range for T_J and T_A ; $V_{BUS} = 5.0\text{ V}$; HZ_MODE ; $OPA_MODE = 0$; (Charge Mode); SCL, SDA, OTG = 0 or 1.8 V; and typical values are for $T_J = 25^\circ\text{C}$) (continued)

Symbol	Parameter	Conditions	Min	Typ	Max	Unit
PROTECTION AND TIMERS						
V _{BUS} OVP	VBUS Over-Voltage Shutdown	V _{BUS} Rising	6.09	6.29	6.49	V
	Hysteresis	V _{BUS} Falling	–	100	–	mV
I _{LIMPK} (CHG)	Q1 Cycle-by-Cycle Peak Current Limit	Charge Mode	–	2.3	–	A
V _{SHORT}	Battery Short-Circuit Threshold	V _{BAT} Rising	1.95	2.00	2.05	V
	Hysteresis	V _{BAT} Falling	–	100	–	mV
I _{SHORT}	Linear Charging Current	V _{BAT} < V _{SHORT}	20	30	40	mA
T _{SHUTDOWN}	Thermal Shutdown Threshold (Note 6)	T _J Rising	–	145	–	°C
	Hysteresis (Note 6)	T _J Falling	–	10	–	
T _{CF}	Thermal Regulation Threshold (Note 6)	Charge Current Reduction Begins	–	120	–	°C
t _{INT}	Detection Interval		–	2.1	–	s
t _{32S}	32-Second Timer (Note 7)	Charger Enabled	20.5	25.2	28.0	s
		Charger Disabled	18.0	25.2	34.0	
t _{15MIN}	15-Minute Timer	15-Minute Mode	12.0	13.5	15.0	min
Δt _{LF}	Low-Frequency Timer Accuracy	Charger Inactive	–25	–	25	%

Product parametric performance is indicated in the Electrical Characteristics for the listed test conditions, unless otherwise noted. Product performance may not be indicated by the Electrical Characteristics if operated under different conditions.

4. Negative current is current flowing from the battery to V_{BUS} (discharging the battery).
5. Q2 always turns on for 60 ns, then turns off if current is below I_{SYNC}.
6. Guaranteed by design; not tested in production.
7. This tolerance (%) applies to all timers on the IC, including soft-start and deglitching timers.

I²C TIMING SPECIFICATIONS (Guaranteed by design)

Symbol	Parameter	Conditions	Min	Typ	Max	Unit	
f _{SCL}	SCL Clock Frequency	Standard Mode	–	–	100	kHz	
		Fast Mode	–	–	400		
		High-Speed Mode, C _B ≤ 100 pF	–	–	3400		
		High-Speed Mode, C _B ≤ 400 pF	–	–	1700		
t _{BUF}	Bus-Free Time between STOP and START Conditions	Standard Mode	–	4.7	–	μs	
		Fast Mode	–	1.3	–		
t _{HD;STA}	START or Repeated START Hold Time	Standard Mode	–	4	–	μs	
		Fast Mode	–	600	–		ns
		High-Speed Mode	–	160	–		
t _{LOW}	SCL LOW Period	Standard Mode	–	4.7	–	μs	
		Fast Mode	–	1.3	–		μs
		High-Speed Mode, C _B ≤ 100 pF	–	160	–		
		High-Speed Mode, C _B ≤ 400 pF	–	320	–		
t _{HIGH}	SCL HIGH Period	Standard Mode	–	4	–	μs	
		Fast Mode	–	600	–		ns
		High-Speed Mode, C _B ≤ 100 pF	–	60	–		
		High-Speed Mode, C _B ≤ 400 pF	–	120	–		
t _{SU;STA}	Repeated START Setup Time	Standard Mode	–	4.7	–	μs	
		Fast Mode	–	600	–		ns

FAN54015

I²C TIMING SPECIFICATIONS (Guaranteed by design) (continued)

Symbol	Parameter	Conditions	Min	Typ	Max	Unit
		High-Speed Mode	-	160	-	ns
t _{SU;DAT}	Data Setup Time	Standard Mode	-	250	-	ns
		Fast Mode	-	100	-	
		High-Speed Mode	-	10	-	
t _{HD;DAT}	Data Hold Time	Standard Mode	0	-	3.45	μs
		Fast Mode	0	-	900	ns
		High-Speed Mode, C _B ≤ 100 pF	0	-	70	ns
		High-Speed Mode, C _B ≤ 400 pF	0	-	150	ns
t _{RCL}	SCL Rise Time	Standard Mode	20 + 0.1 C _B		1000	ns
		Fast Mode	20 + 0.1 C _B		300	
		High-Speed Mode, C _B ≤ 100 pF	-	10	80	
		High-Speed Mode, C _B ≤ 400 pF	-	20	160	
t _{FCL}	SCL Fall Time	Standard Mode	20 + 0.1 C _B		300	ns
		Fast Mode	20 + 0.1 C _B		300	
		High-Speed Mode, C _B ≤ 100 pF	-	10	40	
		High-Speed Mode, C _B ≤ 400 pF	-	20	80	
t _{RDA} t _{RCL1}	SDA Rise Time Rise Time of SCL after a Repeated START Condition and after ACK Bit	Standard Mode	20 + 0.1 C _B		1000	ns
		Fast Mode	20 + 0.1 C _B		300	
		High-Speed Mode, C _B ≤ 100 pF	-	10	80	
		High-Speed Mode, C _B ≤ 400 pF	-	20	160	
t _{FDA}	SDA Fall Time	Standard Mode	20 + 0.1 C _B		300	ns
		Fast Mode	20 + 0.1 C _B		300	
		High-Speed Mode, C _B ≤ 100 pF	-	10	80	
		High-Speed Mode, C _B ≤ 400 pF	-	20	160	
t _{SU;STO}	Stop Condition Setup Time	Standard Mode	-	4	-	μs
		Fast Mode	-	600	-	ns
		High-Speed Mode	-	160	-	ns
C _B	Capacitive Load for SDA, SCL		-	-	400	pF

TIMING DIAGRAMS

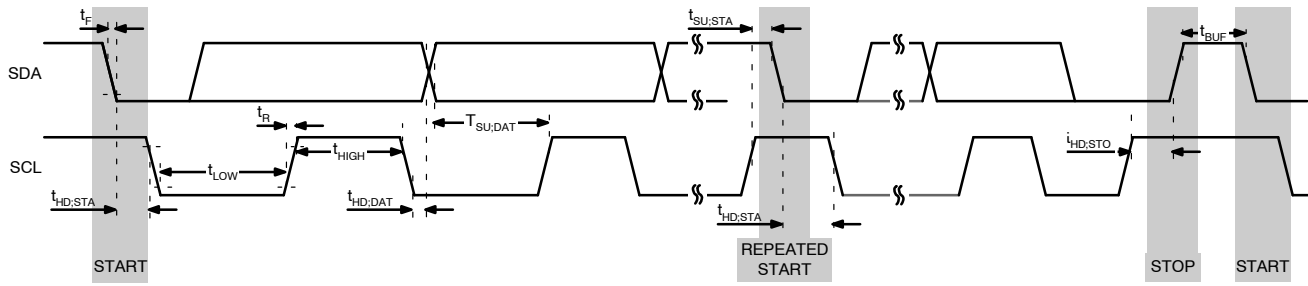
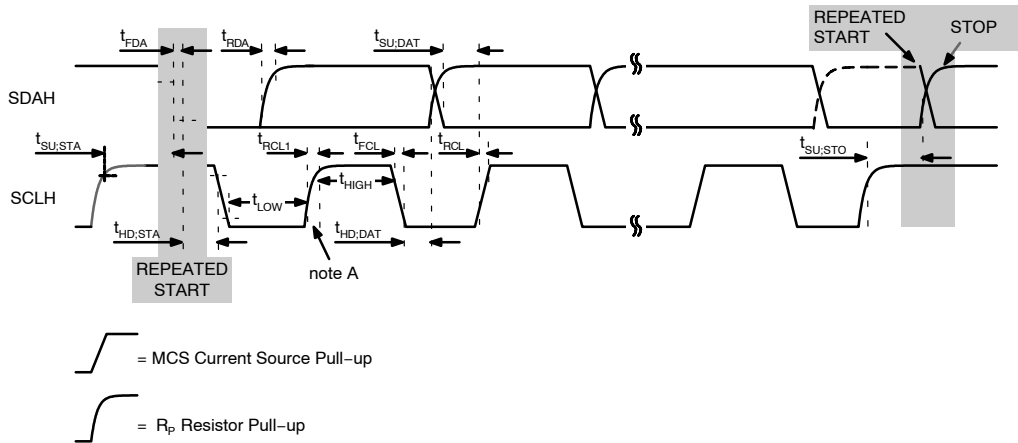

Figure 4. I²C Interface Timing for Fast and Slow Modes



Note A: First rising edge of SCLH after Repeated Start and after each ACK bit.

Figure 5. I²C Interface Timing for High-Speed Mode

CHARGE MODE TYPICAL CHARACTERISTICS

(Unless otherwise specified, circuit of Figure 1, $V_{OREG} = 4.2\text{ V}$, $V_{BUS} = 5.0\text{ V}$, and $T_A = 25^\circ\text{C}$)

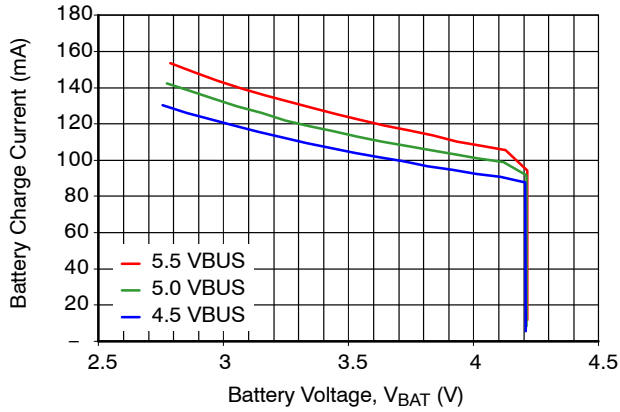

Figure 6. Battery Charge Current vs. V_{BUS} with $I_{INLIM} = 100\text{ mA}$

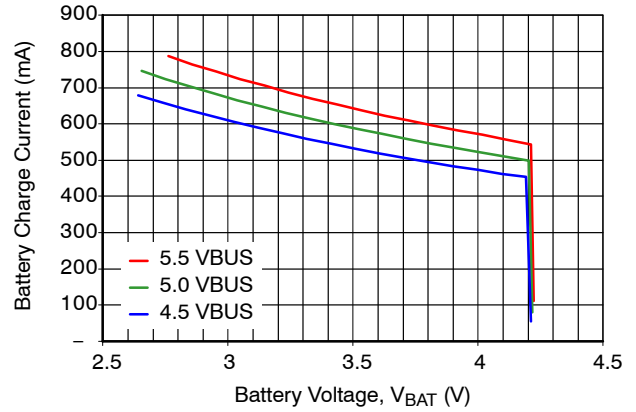

Figure 7. Battery Charge Current vs. V_{BUS} with $I_{INLIM} = 500\text{ mA}$

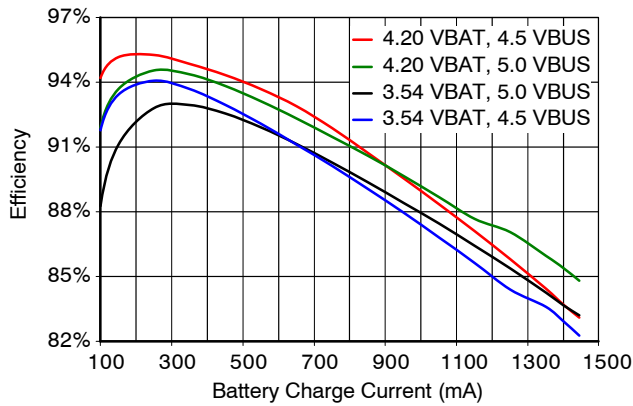

Figure 8. Charger Efficiency, No I_{INLIM} , $I_{OCHARGE} = 1450\text{ mA}$

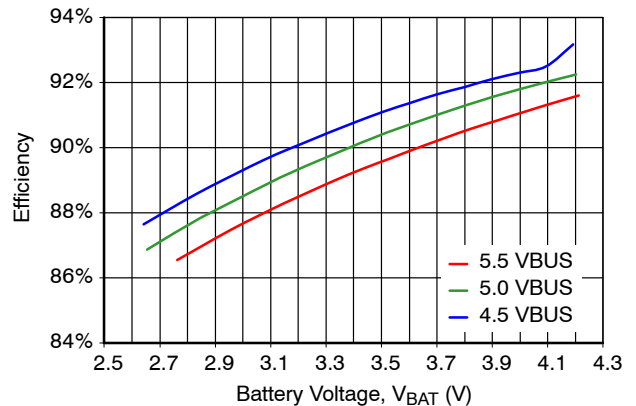

Figure 9. Charger Efficiency vs. V_{BUS} , $I_{INLIM} = 500\text{ mA}$

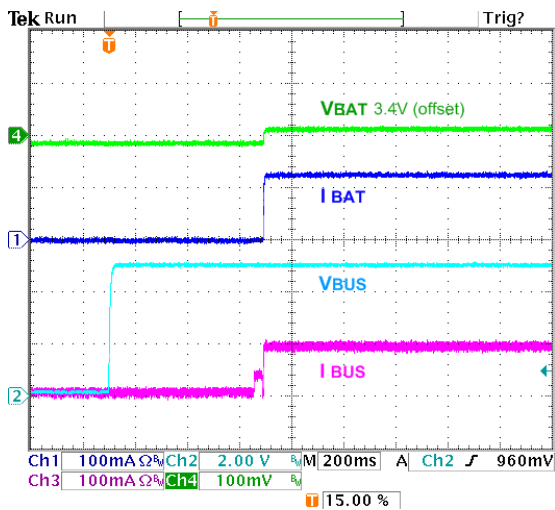

Figure 10. Auto-Charge Startup at V_{BUS} Plug-in, $I_{INLIM} = 100\text{ mA}$, $OTG = 1$, $V_{BAT} = 3.4\text{ V}$

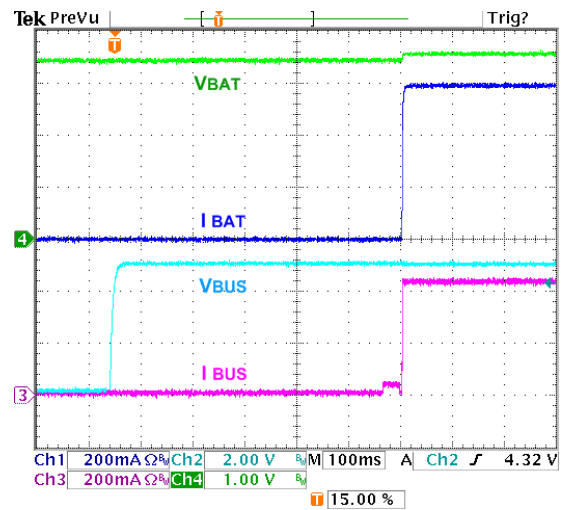

Figure 11. Auto-Charge Startup at V_{BUS} Plug-in, $I_{INLIM} = 500\text{ mA}$, $OTG=1$, $V_{BAT} = 3.4\text{ V}$

CHARGE MODE TYPICAL CHARACTERISTICS

(Unless otherwise specified, circuit of Figure 1, $V_{OREG} = 4.2\text{ V}$, $V_{BUS} = 5.0\text{ V}$, and $T_A = 25^\circ\text{C}$) (continued)

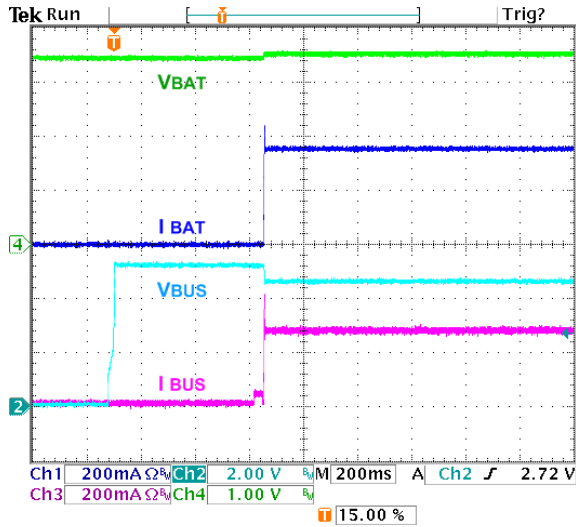

Figure 12. AutoCharge Startup with 300mA Limited Charger / Adaptor, $I_{INLIM} = 500\text{ mA}$, $OTG = 1$, $V_{BAT} = 3.4\text{ V}$

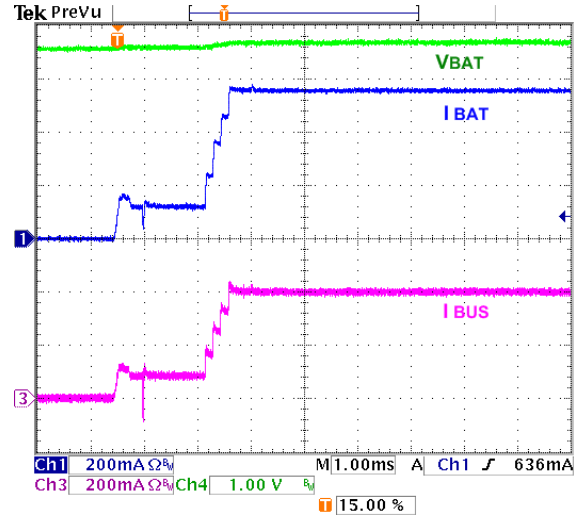

Figure 13. Charger Startup with HZ_MODE Bit Reset, $I_{INLIM} = 500\text{ mA}$, $I_{OCHARGE} = 1050\text{ mA}$, $OREG = 4.2\text{ V}$, $V_{BAT} = 3.6\text{ V}$

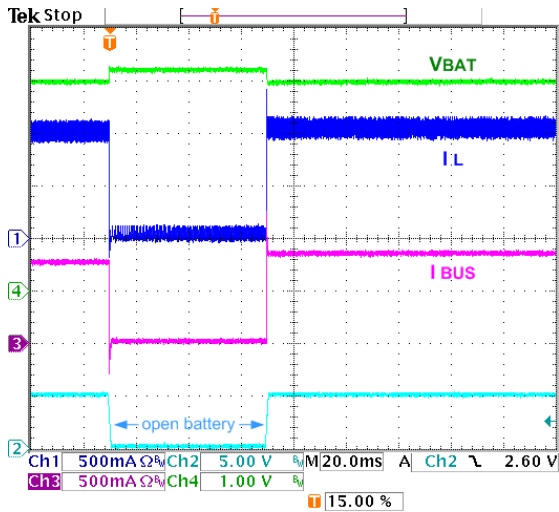

Figure 14. Battery Removal / Insertion During Charging, $V_{BAT} = 3.9\text{ V}$, $I_{OCHARGE} = 1050\text{ mA}$, No I_{INLIM} , $TE = 0$

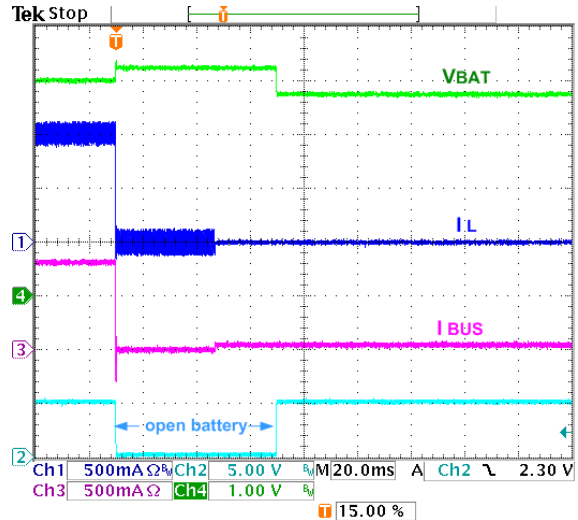

Figure 15. Battery Removal / Insertion During Charging, $V_{BAT} = 3.9\text{ V}$, $I_{OCHARGE} = 1050\text{ mA}$, No I_{INLIM} , $TE = 1$

CHARGE MODE TYPICAL CHARACTERISTICS

(Unless otherwise specified, circuit of Figure 1, $V_{OREG} = 4.2\text{ V}$, $V_{BUS} = 5.0\text{ V}$, and $T_A = 25^\circ\text{C}$) (continued)

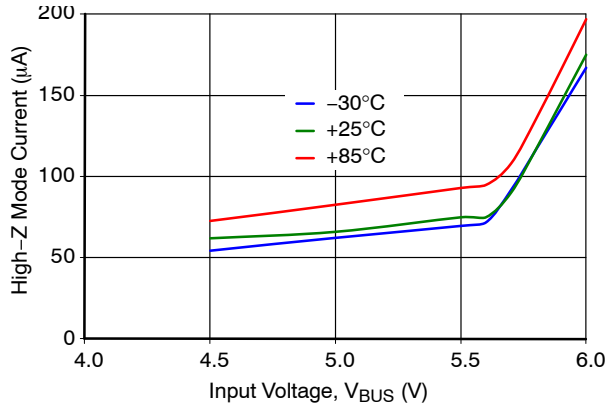

Figure 16. V_{BUS} Current in High-Impedance Mode with Battery Open

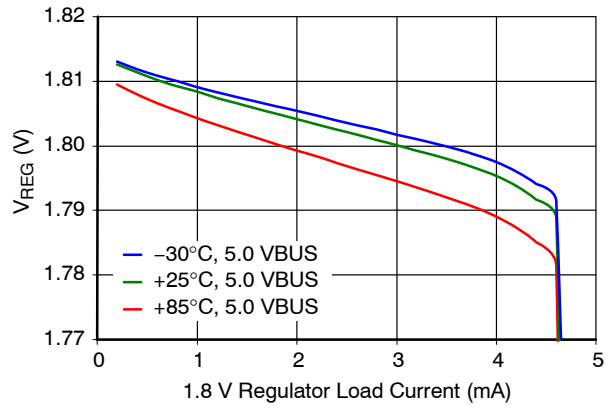

Figure 17. V_{REG} 1.8 V Output Regulation

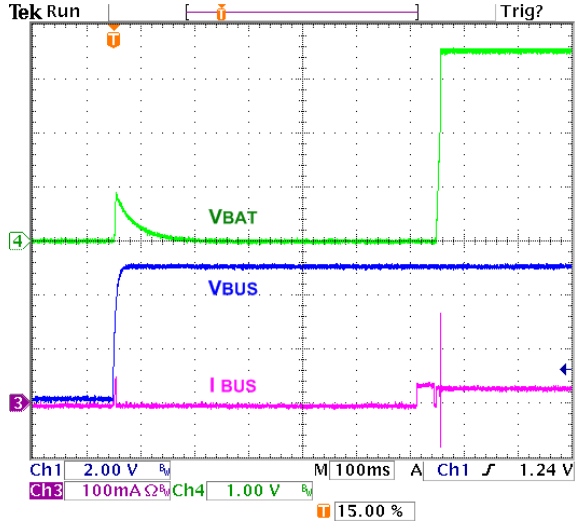

Figure 18. No Battery, V_{BUS} at Power Up

BOOST MODE TYPICAL CHARACTERISTICS

(Unless otherwise specified, using circuit of Figure 1, $V_{BAT} = 3.6\text{ V}$, $T_A = 25^\circ\text{C}$)

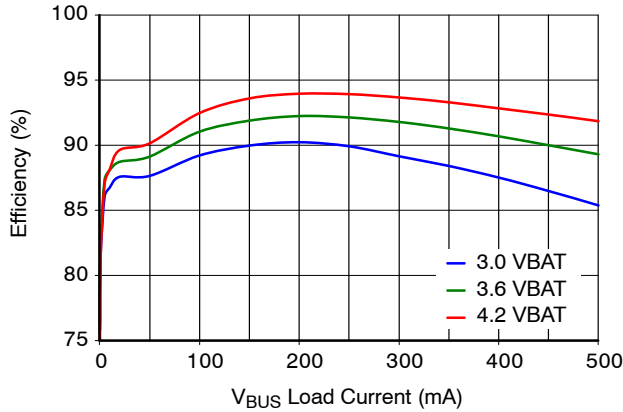

Figure 19. Efficiency vs. V_{BAT}

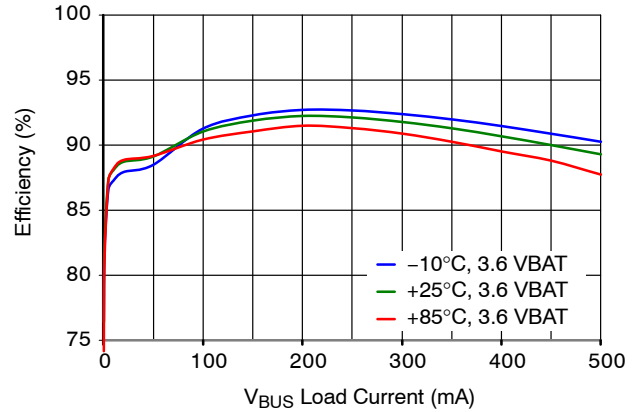

Figure 20. Efficiency Over Temperature

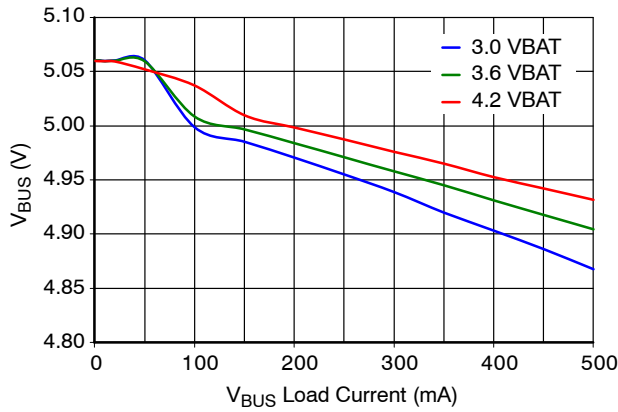

Figure 21. Output Regulation vs. V_{BAT}

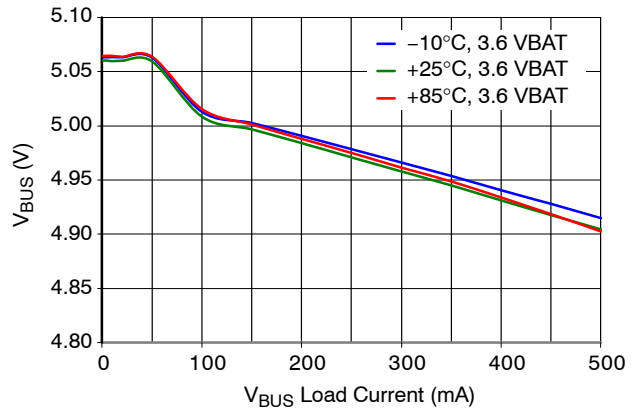

Figure 22. Output Regulation Over Temperature

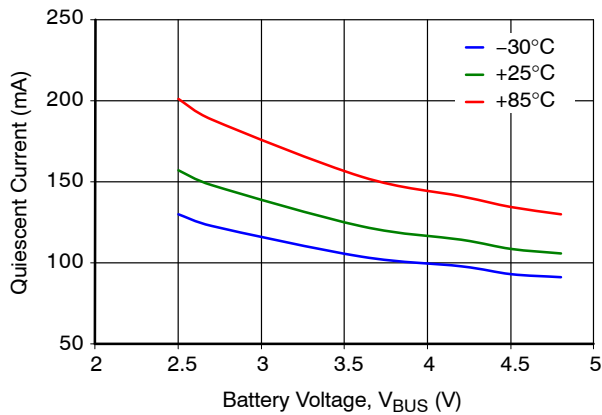

Figure 23. Quiescent Current

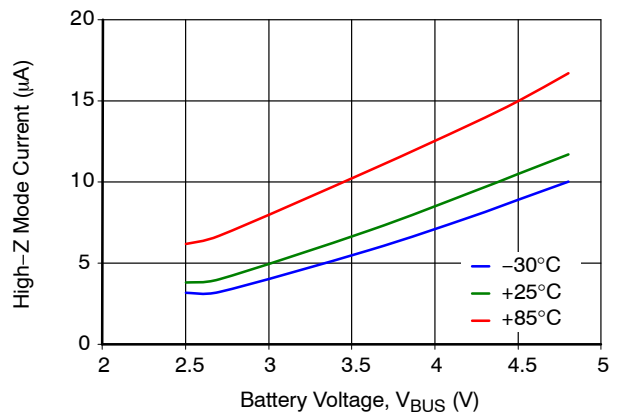

Figure 24. High-Impedance Mode Battery Current

BOOST MODE TYPICAL CHARACTERISTICS

(Unless otherwise specified, using circuit of Figure 1, $V_{BAT} = 3.6\text{ V}$, $T_A = 25^\circ\text{C}$)

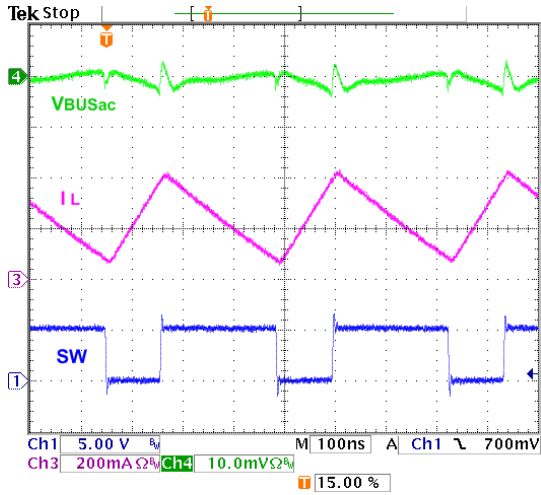

Figure 27. Boost PWM Waveform

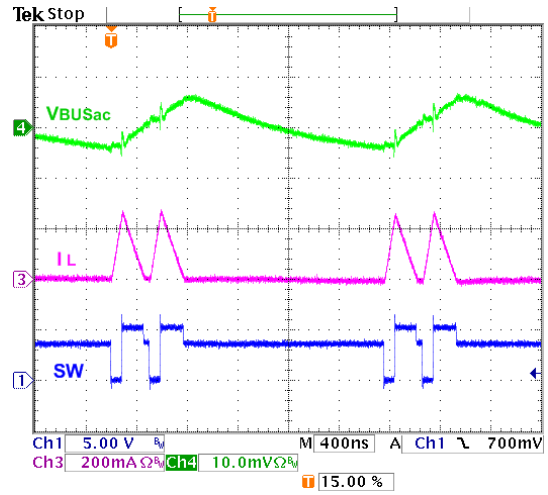

Figure 28. Boost PFM Waveform

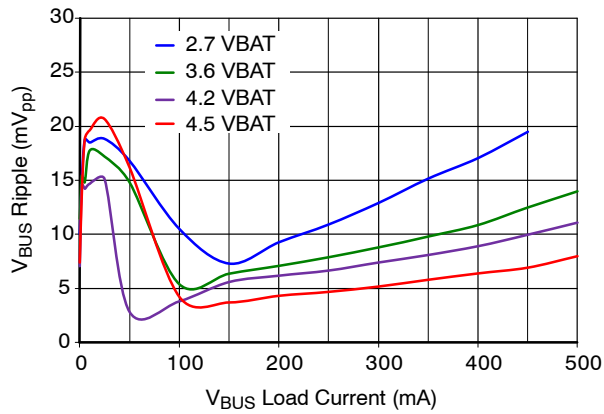

Figure 25. Output Ripple vs. V_{BAT}

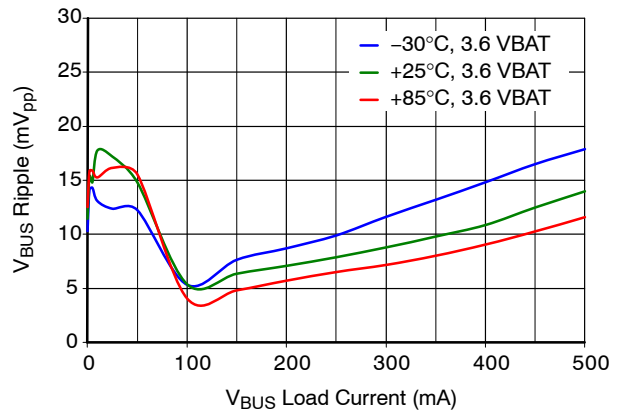

Figure 26. Output Ripple vs. Temperature

BOOST MODE TYPICAL CHARACTERISTICS

(Unless otherwise specified, using circuit of Figure 1, $V_{BAT} = 3.6\text{ V}$, $T_A = 25^\circ\text{C}$)

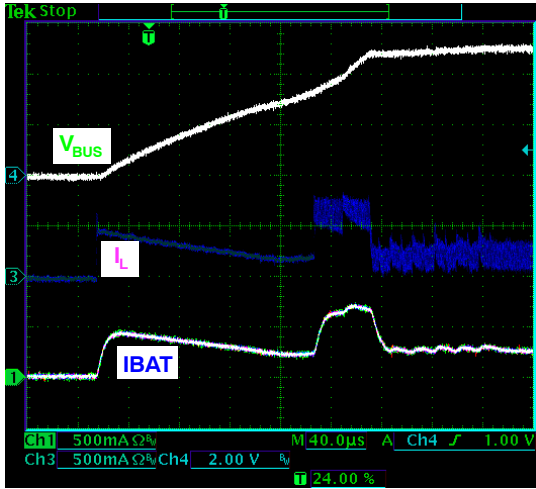

Figure 29. Startup, 3.6 V_{BAT} , 44 Ω Load, Additional 10 μF , X5R Across V_{BUS}

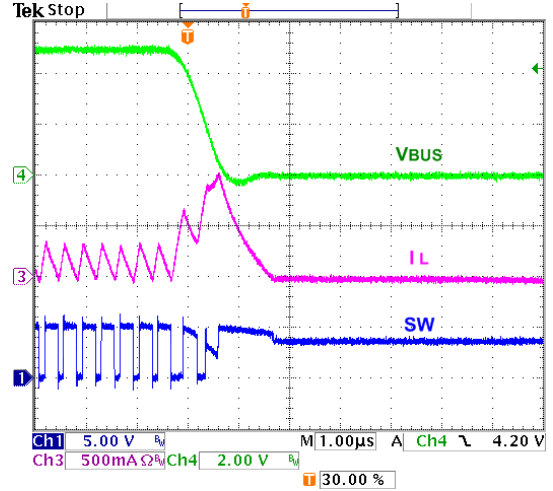

Figure 30. V_{BUS} Fault Response, 3.6 V_{BAT}

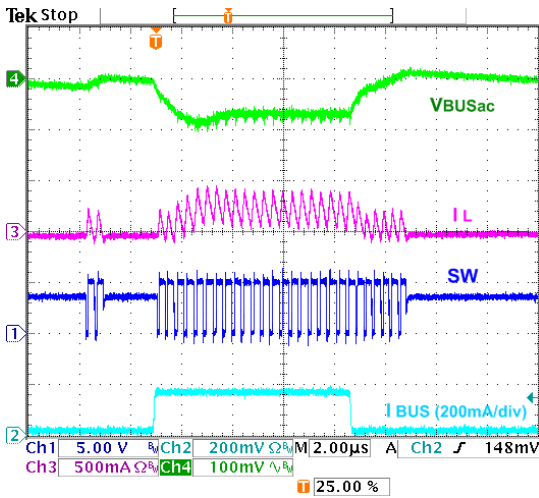

Figure 31. Load Transient, 5 – 155 – 5 mA, $t_R = t_F = 100\text{ ns}$

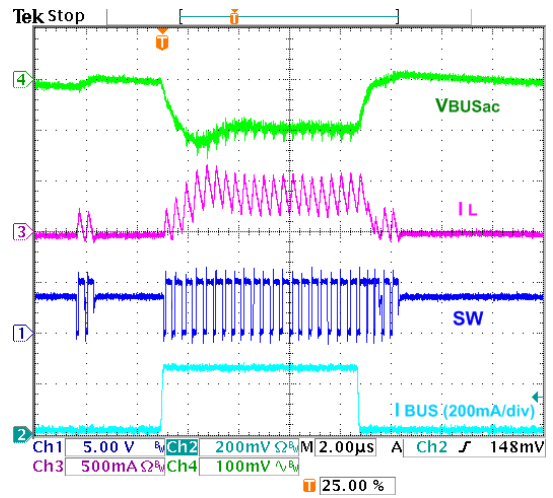

Figure 32. Load Transient, 5 – 255 – 5 mA, $t_R = t_F = 100\text{ ns}$

CIRCUIT DESCRIPTION / OVERVIEW

When charging batteries with a current-limited input source, such as USB, a switching charger’s high efficiency over a wide range of output voltages minimizes charging time.

FAN54015 combines a highly integrated synchronous buck regulator for charging with a synchronous boost regulator, which can supply 5 V to USB On-The-Go (OTG) peripherals. The regulator employs synchronous rectification for both the charger and boost regulators to maintain high efficiency over a wide range of battery voltages and charge states.

The FAN54015 has three operating modes:

1. Charge Mode:
Charges a single-cell Li-ion or Li-polymer battery.
2. Boost Mode:
Provides 5 V power to USB-OTG with an integrated synchronous rectification boost regulator using the battery as input.
3. High-Impedance Mode:
Both the boost and charging circuits are OFF in this mode. Current flow from VBUS to the battery or from the battery to VBUS is blocked in this mode. This mode consumes very little current from VBUS or the battery.

NOTE: Default settings are denoted by **bold typeface**.

Charge Mode

In Charge Mode, FAN54015 employs four regulation loops:

1. Input Current: Limits the amount of current drawn from VBUS. This current is sensed internally and can be programmed through the I²C interface.
2. Charging Current: Limits the maximum charging current. This current is sensed using an external R_{SENSE} resistor.
3. Charge Voltage: The regulator is restricted from exceeding this voltage. As the internal battery voltage rises, the battery’s internal impedance and R_{SENSE} work in conjunction with the charge voltage regulation to decrease the amount of current flowing to the battery. Battery charging is completed when the voltage across R_{SENSE} drops below the I_{TERM} threshold.
4. Temperature: If the IC’s junction temperature reaches 120°C, charge current is reduced until the IC’s temperature stabilizes at 120°C.
5. An additional loop limits the amount of drop on VBUS to a programmable voltage (V_{SP}) to accommodate “special chargers” that limit current to a lower current than might be available from a “normal” USB wall charger.

Battery Charging Curve

If the battery voltage is below V_{SHORT}, a linear current source pre-charges the battery until V_{BAT} reaches V_{SHORT}. The PWM charging circuit is then started and the battery is charged with a constant current if sufficient input power is available. The current slew rate is limited to prevent overshoot.

The FAN54015 is designed to work with a current-limited input source at VBUS. During the current regulation phase of charging, I_{INLIM} or the programmed charging current limits the amount of current available to charge the battery and power the system. The effect of I_{INLIM} on I_{CHARGE} can be seen in Figure 34.

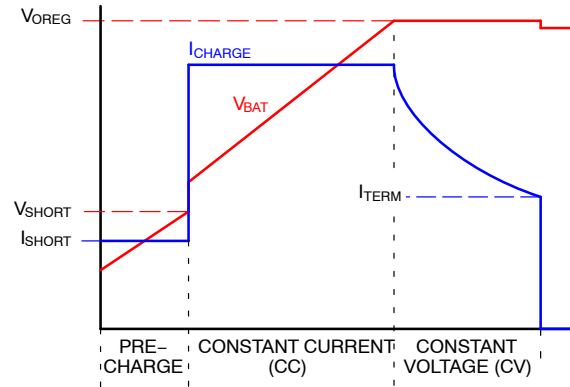

Figure 33. Charge Curve, I_{CHARGE} Not Limited by I_{INLIM}

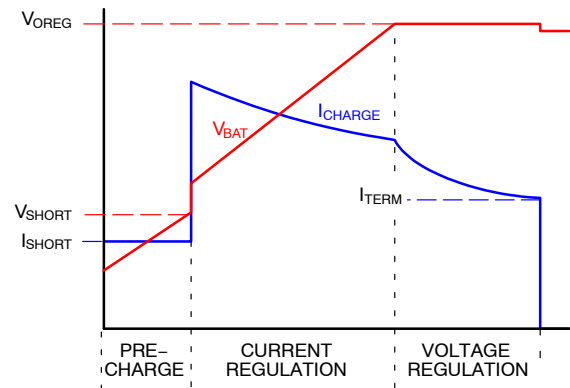

Figure 34. Charge Curve, I_{INLIM} Limits I_{CHARGE}

Assuming that V_{OREG} is programmed to the cell’s fully charged “float” voltage, the current that the battery accepts with the PWM regulator limiting its output (sensed at V_{BAT}) to V_{OREG} declines, and the charger enters the voltage regulation phase of charging. When the current declines to the programmed I_{TERM} value, the charge cycle is complete. Charge current termination can be disabled by resetting the TE bit (REG1[3]).

The charger output or “float” voltage can be programmed by the OREG bits from 3.5 V to 4.44 V in 20 mV increments, as shown in Table 3.

Table 3. OREG BITS (OREG[7:2]) VS. CHARGER V_{OUT} (V_{OREG}) FLOAT VOLTAGE

Decimal	Hex	VOREG	Decimal	Hex	VOREG
0	00	3.50	32	20	4.14
1	01	3.52	33	21	4.16
2	02	3.54	34	22	4.18
3	03	3.56	35	23	4.20
4	04	3.58	36	24	4.22
5	05	3.60	37	25	4.24
6	06	3.62	38	26	4.26
7	07	3.64	39	27	4.28
8	08	3.66	40	28	4.30
9	09	3.68	41	29	4.32
10	0A	3.70	42	2A	4.34
11	0B	3.72	43	2B	4.36
12	0C	3.74	44	2C	4.38
13	0D	3.76	45	2D	4.40
14	0E	3.78	46	2E	4.42
15	0F	3.80	47	2F	4.44
16	10	3.82	48	30	4.44
17	11	3.84	49	31	4.44
18	12	3.86	50	32	4.44
19	13	3.88	51	33	4.44
20	14	3.90	52	34	4.44
21	15	3.92	53	35	4.44
22	16	3.94	54	36	4.44
23	17	3.96	55	37	4.44
24	18	3.98	56	38	4.44
25	19	4.00	57	39	4.44
26	1A	4.02	58	3A	4.44
27	1B	4.04	59	3B	4.44
28	1C	4.06	60	3C	4.44
29	1D	4.08	61	3D	4.44
30	1E	4.10	62	3E	4.44

The following charging parameters can be programmed by the host through I²C:

Table 4. PROGRAMMABLE CHARGING PARAMETERS

Parameter	Name	Register
Output Voltage Regulation	V _{OREG}	REG2[7:2]
Battery Charging Current Limit	I _{OCHRG}	REG4[6:4]
Input Current Limit	I _{INLIM}	REG1[7:6]
Charge Termination Limit	I _{TERM}	REG4[2:0]
Weak Battery Voltage	V _{LOWV}	REG1[5:4]

A new charge cycle begins when one of the following occurs:

- The battery voltage falls below V_{OREG} - V_{RCH}
- VBUS Power on Reset (POR) clears and the battery voltage is below the weak battery threshold (V_{LOWV}).
- \overline{CE} or HZ_MODE is reset through I²C write to CONTROL1 (R1) register.

Charge Current Limit (I_{OCHARGE})

Table 5. I_{OCHARGE} (REG4 [6:4]) CURRENT AS FUNCTION OF I_{OCHARGE} BITS AND R_{SENSE} RESISTOR VALUES

DEC	BIN	HEX	V _{RSENSE} (mV)	I _{OCHARGE} (mA)	
				68 mΩ	100 mΩ
0	000	00	37.4	550	374
1	001	01	44.2	650	442
2	010	02	51.0	750	510
3	011	03	57.8	850	578
4	100	04	71.4	1050	714
5	101	05	78.2	1150	782
6	110	06	91.8	1350	918
7	111	07	98.6	1450	986

Termination Current Limit

Current charge termination is enabled when TE (REG1[3]) = 1. Typical termination current values are given in Table 6.

Table 6. I_{TERM} CURRENT AS FUNCTION OF I_{TERM} BITS (REG4[2:0]) AND R_{SENSE} RESISTOR VALUES

I _{TERM}	V _{RSENSE} (mV)	I _{TERM} (mA)	
		68 mΩ	100 mΩ
0	3.3	49	33
1	6.6	97	66
2	9.9	146	99
3	13.2	194	132
4	16.5	243	165
5	19.8	291	198
6	23.1	340	231
7	26.4	388	264

When the charge current falls below I_{TERM}, PWM charging stops and the STAT bits change to READY (00) for about 500 ms while the IC determines whether the battery and charging source are still connected. STAT then changes to CHARGE DONE (10), provided the battery and charger are still connected.

PWM Controller in Charge Mode

The IC uses a current-mode PWM controller to regulate the output voltage and battery charge currents. The synchronous rectifier (Q2) has a current limit that which off the FET when the current is negative by more than 140 mA peak. This prevents current flow from the battery.

Safety Timer

Section references Figure 39.

At the beginning of charging, the IC starts a 15-minute timer (t_{15MIN}). When this times out, charging is terminated. Writing to any register through I²C stops and resets the t_{15MIN} timer, which in turn starts a 32-second timer (t_{32S}). Setting the TMR_RST bit (REG0[7]) resets the t_{32S} timer. If the t_{32S} timer times out; charging is terminated, the registers are set to their default values, and charging resumes using the default values with the t_{15MIN} timer running.

Normal charging is controlled by the host with the t_{32S} timer running to ensure that the host is alive. Charging with the t_{15MIN} timer running is used for charging that is unattended by the host. If the t_{15MIN} timer expires; the IC turns off the charger, sets the CE bit, and indicates a timer fault (110) on the FAULT bits (REG0[2:0]). This sequence prevents overcharge if the host fails to reset the t_{32S} timer.

V_{BUS} POR / Non-Compliant Charger Rejection

When the IC detects that V_{BUS} has risen above V_{IN(MIN)1} (4.4 V), the IC applies a 100 Ω load from V_{BUS} to GND. To clear the V_{BUS} POR (Power-On-Reset) and begin charging, V_{BUS} must remain above V_{IN(MIN)1} and below V_{BUSOVP} for t_{VBUS_VALID} (30 ms) before the IC initiates charging. The V_{BUS} validation sequence always occurs before charging is initiated or re-initiated (for example, after a V_{BUS} OVP fault or a V_{RCH} recharge initiation).

t_{VBUS_VALID} ensures that unfiltered 50 / 60 Hz chargers and other non-compliant chargers are rejected.

USB-Friendly Boot Sequence

At V_{BUS} POR, when the battery voltage is above the weak battery threshold (V_{LOWV}), the IC operates in accordance with its I²C register settings. If V_{BAT} < V_{LOWV}, the IC sets all registers to their default values and enables the charger using an input current limit controlled by the OTG pin (100 mA if OTG is LOW and 500 mA if OTG is HIGH). This feature can revive a battery whose voltage is too low to ensure reliable host operation. Charging continues in the absence of host communication even after the battery has reached V_{OREG}, whose default value is 3.54 V, and the charger remains active until t_{15MIN} times out. Once the host processor begins writing to the IC, charging parameters are set by the host, which must continually reset the t_{32S} timer to continue charging using the programmed charging parameters. If t_{32S} times out, the register defaults are loaded, the FAULT bits are set to 110, STAT is pulsed HIGH, and charging continues with default charge parameters.

Input Current Limiting

To minimize charging time without overloading V_{BUS} current limitations, the IC's input current limit can be programmed by the I_{INLIM} bits (REG1[7:6]).

Table 7. INPUT CURRENT LIMIT

I _{INLIM} REG1[7:6]	Input Current Limit
00	100 mA
01	500 mA
10	800 mA
11	No limit

The OTG pin establishes the input current limit when t_{15MIN} is running.

FLOW CHARTS

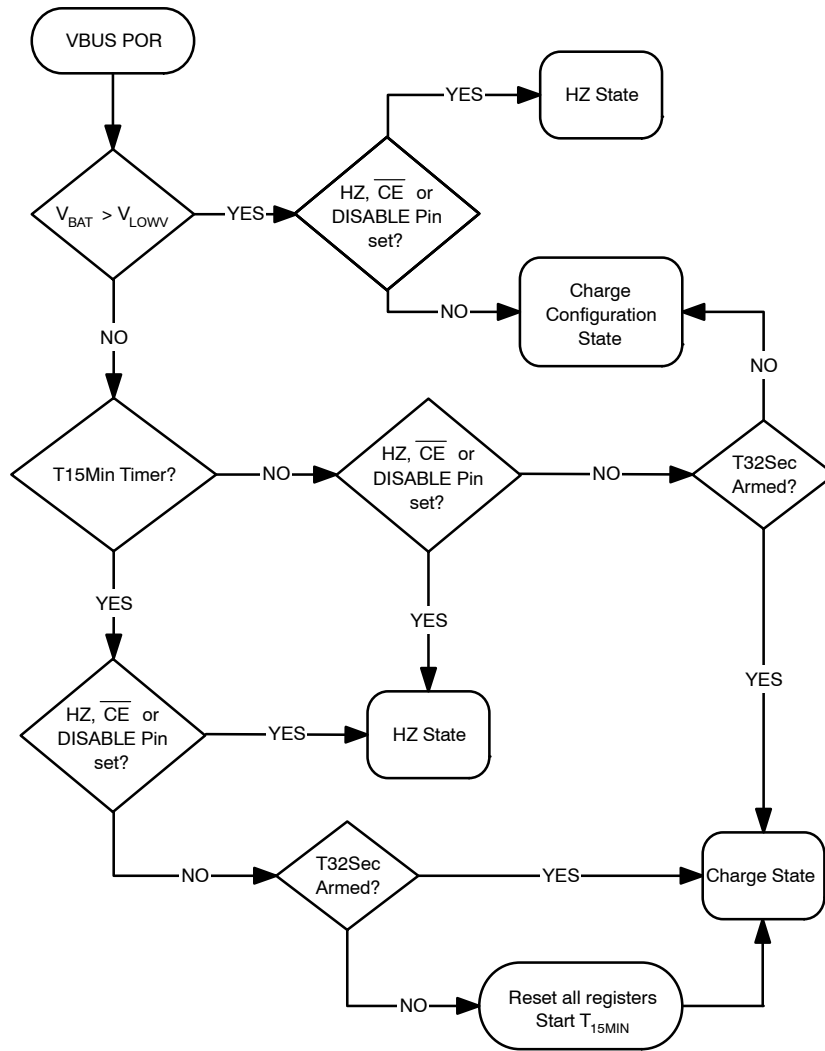

Figure 35. Charger VBUS PO

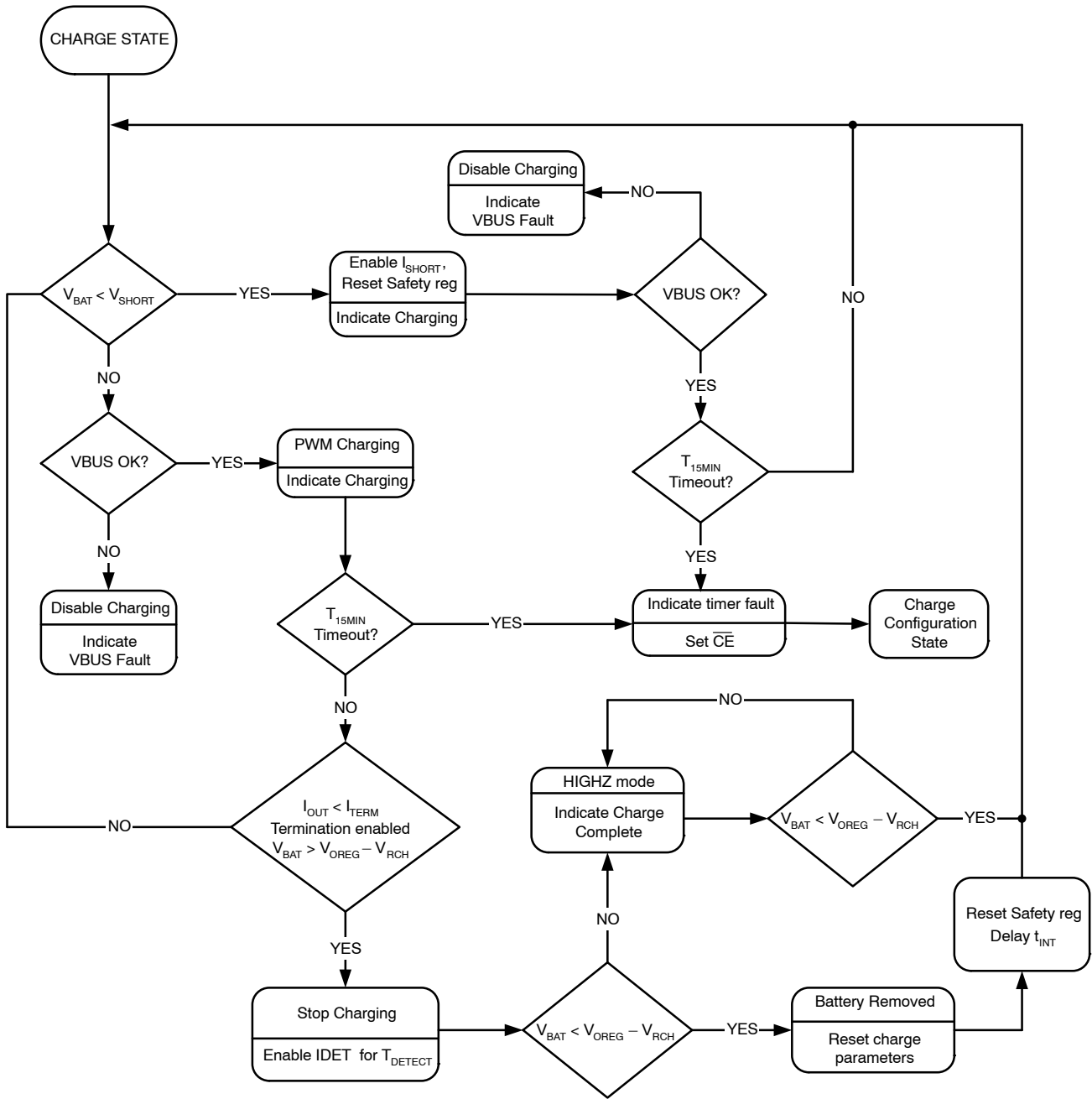

Figure 36. Charge Mode

FLOW CHARTS (continued)

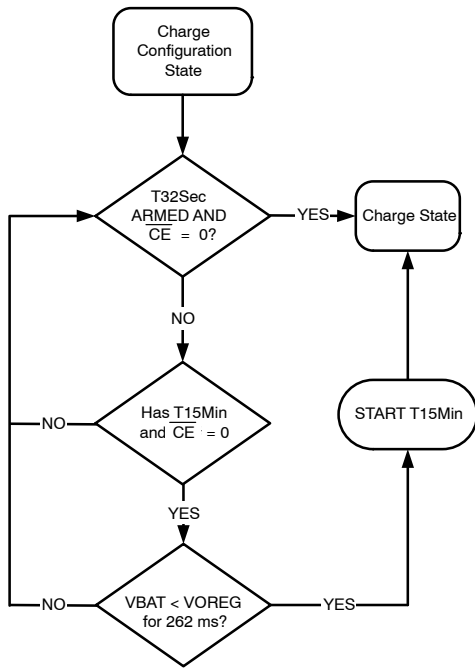

Figure 37. Charge Configuration

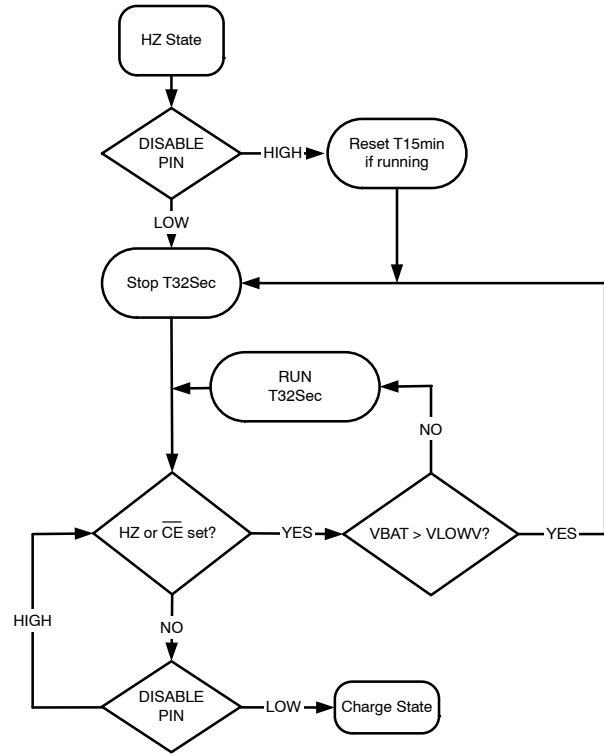

Figure 38. HZ-State

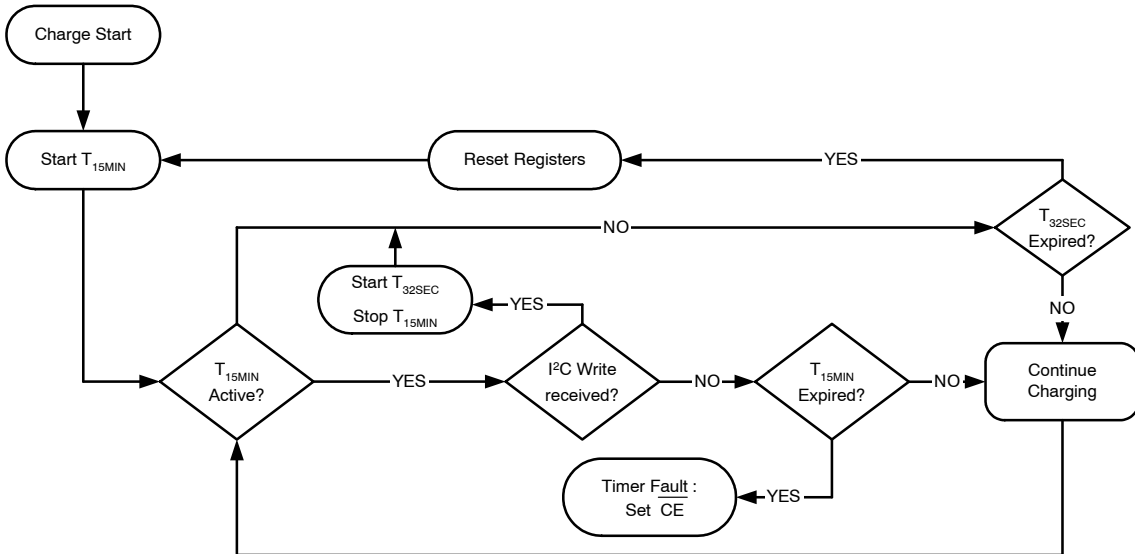

Figure 39. Timer Flow Chart

Special Charger

The FAN54015 has additional functionality to limit input current in case a current-limited “special charger” is supplying VBUS. These slowly increase the charging current until either:

- I_{NLIM} or $I_{OCHARGE}$ is reached

or

- $V_{BUS} = V_{SP}$

If V_{BUS} collapses to V_{SP} when the current is ramping up, the FAN54015 charge with an input current that keeps $V_{BUS} = V_{SP}$. When the V_{SP} control loop is limiting the charge current, the SP bit (REG5[4]) is set.

Table 8. V_{SP} AS FUNCTION OF SP BITS (REG5[2:0])

SP (REG5[2:0])			
DEC	BIN	HEX	V_{SP}
0	000	00	4.213
1	001	01	4.293
2	010	02	4.373
3	011	03	4.453
4	100	04	4.533
5	101	05	4.613
6	110	06	4.693
7	111	07	4.773

Safety Settings

FAN54015 contain a SAFETY register (REG6) that prevents the values in OREG (REG2[7:2]) and IOCHARGE (REG4[6:4]) from exceeding the values of the VSAFE and ISAFE values.

After V_{BAT} exceeds V_{SHORT} , the SAFETY register is loaded with its default value and may be written only before any other register is written. The entire desired Safety register value should be written twice to ensure the register bits are set. After writing to any other register, the SAFETY register is locked until V_{BAT} falls below V_{SHORT} .

The ISAFE (REG6[6:4]) and VSAFE (REG6[3:0]) registers establish values that limit the maximum values of IOCHARGE and VOREG used by the control logic. If the host attempts to write a value higher than VSAFE or ISAFE to OREG or IOCHARGE, respectively; the VSAFE, ISAFE value appears as the OREG, IOCHARGE register value, respectively.

Table 9. I_{SAFE} ($I_{OCHARGE}$ LIMIT) AS FUNCTION OF ISAFE BITS (REG6[6:4])

ISAFE (REG6[6:4])					
DEC	BIN	HEX	V_{RSENSE} (mV)	I_{SAFE} (mA)	
				68 mΩ	100 mΩ
0	000	00	37.4	550	374
1	001	01	44.2	650	442
2	010	02	51.0	750	510
3	011	03	57.8	850	578
4	100	04	71.4	1050	714
5	101	05	78.2	1150	782
6	110	06	91.8	1350	918
7	111	07	98.6	1450	986

Table 10. V_{SAFE} (V_{OREG} LIMIT) AS FUNCTION OF VSAFE BITS (REG6[3:0])

VSAFE (REG6[3:0])				
DEC	BIN	HEX	Max. OREG (REG2[7:2])	VOREG Max.
0	0000	00	100011	4.20
1	0001	01	100100	4.22
2	0010	02	100101	4.24
3	0011	03	100110	4.26
4	0100	04	100111	4.28
5	0101	05	101000	4.30
6	0110	06	101001	4.32
7	0111	07	101010	4.34
8	1000	08	101011	4.36
9	1001	09	101100	4.38
10	1010	0A	101101	4.40
11	1011	0B	101110	4.42
12	1100	0C	101111	4.44
13	1101	0D	110000	4.44
14	1110	0E	110001	4.44
15	1111	0F	110010	4.44

Thermal Regulation and Protection

When the IC’s junction temperature reaches T_{CF} (about 120°C), the charger reduces its output current to 550 mA to prevent overheating. If the temperature increases beyond $T_{SHUTDOWN}$; charging is suspended, the FAULT bits are set to 101, and STAT is pulsed HIGH. In Suspend Mode, all timers stop and the state of the IC’s logic is preserved. Charging resumes at programmed current after the die cools to about 120°C.

Additional θ_{JA} data points, measured using the FAN54015 evaluation board, are given in Table 11 (measured with $T_A = 25^\circ\text{C}$). Note that as power dissipation increases, the effective θ_{JA} decreases due to the larger difference between the die temperature and ambient.

Table 11. EVALUATION BOARD MEASURED θ_{JA}

Power (W)	θ_{JA}
0.504	54°C/W
0.844	50°C/W
1.506	46°C/W

Charge Mode Input Supply Protection

Sleep Mode

When V_{BUS} falls below $V_{BAT} + V_{SLP}$ and V_{BUS} is above $V_{IN(MIN)}$, the IC enters Sleep Mode to prevent the battery from draining into VBUS. During Sleep Mode, reverse current is disabled by body switching Q1.

Input Supply Low–Voltage Detection

The IC continuously monitors VBUS during charging. If V_{BUS} falls below $V_{IN(MIN)}$, the IC:

1. Terminates charging
2. Pulses the STAT pin, sets the STAT bits to 11, and sets the FAULT bits to 011.

If V_{BUS} recovers above the $V_{IN(MIN)}$ rising threshold after time t_{INT} (about two seconds), the charging process is repeated. This function prevents the USB power bus from collapsing or oscillating when the IC is connected to a suspended USB port or a low–current–capable OTG device.

Input Over–Voltage Detection

When the V_{BUS} exceeds $V_{BUS_{OVP}}$, the IC:

1. Turns off Q3
2. Suspends charging
3. Sets the FAULT bits to 001, sets the STAT bits to 11, and pulses the STAT pin.

When V_{BUS} falls about 150 mV below $V_{BUS_{OVP}}$, the fault is cleared and charging resumes after V_{BUS} is revalidated (see [VBUS POR / Non–Compliant Charger Rejection](#)).

VBUS Short While Charging

If VBUS is shorted with a very low impedance while the IC is charging with $I_{INLIMIT} = 100\text{ mA}$, the IC may not meet datasheet specifications until power is removed. To trigger

this condition, V_{BUS} must be driven from 5 V to GND with a high slew rate. Achieving this slew rate requires a 0 Ω short to the USB cable less than 10 cm from the connector.

Charge Mode Battery Detection & Protection

VBAT Over–Voltage Protection

The OREG voltage regulation loop prevents V_{BAT} from overshooting the OREG voltage by more than 50 mV when the battery is removed. When the PWM charger runs with no battery, the TE bit is not set and a battery is inserted that is charged to a voltage higher than V_{OREG} ; PWM pulses stop. If no further pulses occur for 30 ms, the IC sets the FAULT bits to 100, sets the STAT bits to 11, and pulses the STAT pin.

Battery Detection During Charging

The IC can detect the presence, absence, or removal of a battery if the termination bit (TE) is set. During normal charging, once V_{BAT} is close to V_{OREG} and the termination charge current is detected, the IC terminates charging and sets the STAT bits to 10. It then turns on a discharge current, I_{DETECT} , for t_{DETECT} . If V_{BAT} is still above $V_{OREG} - V_{RCH}$, the battery is present and the IC sets the FAULT bits to 000. If V_{BAT} is below $V_{OREG} - V_{RCH}$, the battery is absent and the IC:

1. Sets the registers to their default values.
2. Sets the FAULT bits to 111.
3. Resumes charging with default values after t_{INT} .

Battery Short–Circuit Protection

If the battery voltage is below the short–circuit threshold (V_{SHORT}); a linear current source, I_{SHORT} , supplies V_{BAT} until $V_{BAT} > V_{SHORT}$.

System Operation with No Battery

The FAN54015 continues charging after VBUS POR with the default parameters, regulating the V_{BAT} line to 3.54 V until the host processor issues commands or the 15–minute timer expires. In this way, the FAN54015 can start the system without a battery.

The FAN54015 soft–start function can interfere with the system supply with battery absent. The soft–start activates whenever V_{OREG} , I_{INLIM} , or $I_{OCHARGE}$ are set from a lower to higher value. During soft–start, the I_{IN} limit drops to 100 mA for about 1 ms unless I_{INLIM} is set to 11 (no limit). This could cause the system processor to fail to start. To avoid this behavior, use the following sequence.

1. Set the OTG pin HIGH. When VBUS is plugged in, I_{INLIM} is set to 500 mA until the system processor powers up and can set parameters through I²C.
2. Program the Safety Register.
3. Set I_{INLIM} to 11 (no limit).
4. Set OREG to the desired value (typically 4.18).
5. Reset the IO_LEVEL bit, then set IOCHARGE.
6. Set I_{INLIM} to 500 mA if a USB source is connected.

During the initial system startup, while the charger IC is being programmed, the system current is limited to 500 mA for 1 ms during steps 4 and 5. This is the value of the soft-start ICHARGE current used when I_{INLIM} is set to No Limit.

If the system is powered up without a battery present, the CV bit should be set. When a battery is inserted, the CV bit is cleared.

Charger Status / Fault Status

The STAT pin indicates the operating condition of the IC and provides a fault indicator for interrupt driven systems.

Table 12. STAT PIN FUNCTION

EN_STAT	Charge State	STAT Pin
0	X	OPEN
X	Normal Conditions	OPEN
1	Charging	LOW
X	Fault (Charging or Boost)	128 μs Pulse, then OPEN

The FAULT bits (R0[2:0]) indicate the type of fault in Charge Mode (see Table 13).

Table 13. FAULT STATUS BITS DURING CHARGE MODE

Fault Bit			Fault Description
B2	B1	B0	
0	0	0	Normal (No Fault)
0	0	1	VBUS OVP
0	1	0	Sleep Mode
0	1	1	Poor Input Source
1	0	0	Battery OVP
1	0	1	Thermal Shutdown
1	1	0	Timer Fault
1	1	1	No Battery

Charge Mode Control Bits

Setting either HZ_MODE or \overline{CE} through I²C disables the charger and puts the IC into High-Impedance Mode and resets t_{32S}. If V_{BAT} < V_{LOWV} while in High-Impedance Mode, t_{32S} begins running and, when it overflows, all registers (except SAFETY) reset, which enables t_{15MIN} charging on versions with the 15-minute timer.

When t_{15MIN} overflows, the IC sets the \overline{CE} bit and the IC enters High-Impedance Mode. If \overline{CE} was set by t_{15MIN} overflow, a new charge cycle can only be initiated through I²C or VBUS POR.

Setting the RESET bit clears all registers. If HZ_MODE or \overline{CE} bits were set when the RESET bit is set, these bits are also cleared, but the t_{32S} timer is not started, and the IC remains in High-Impedance Mode.

Table 14. DISABLE PIN AND \overline{CE} BIT FUNCTIONALITY

Charging	DISABLE Pin	\overline{CE}	HZ_MODE
ENABLE	0	0	0
DISABLE	X	1	X
DISABLE	X	X	1
DISABLE	1	X	X

Raising the DISABLE pin stops t_{32S} from advancing, but does not reset it. If the DISABLE pin is raised during t_{15MIN} charging, the t_{15MIN} timer is reset.

Operational Mode Control

OPA_MODE (REG1[0]) and the HZ_MODE (REG1[1]) bits in conjunction with the FAULT state define the operational mode of the charger.

Table 15. OPERATION MODE CONTROL

HZ_MODE	OPA_MODE	FAULT	Operation Mode
0	0	0	Charge
0	X	1	Charge Configure
0	1	0	Boost
1	X	X	High Impedance

The IC resets the OPA_MODE bit whenever the boost is deactivated, whether due to a fault or being disabled by setting the HZ_MODE bit.

BOOST MODE

Boost Mode can be enabled if the IC is in 32-Second Mode with the OTG pin and OPA_MODE bits as indicated in Table 16. The OTG pin ACTIVE state is 1 if OTG_PL = 1 and 0 when OTG_PL = 0.

If boost is active using the OTG pin, Boost Mode is initiated even if the HZ_MODE = 1. The HZ_MODE bit overrides the OPA_MODE bit.

Table 16. ENABLING BOOST

OTG_EN	OTG Pin	HZ_MODE	OPA_MODE	BOOST
1	ACTIVE	X	X	Enabled
X	X	0	1	Enabled
X	ACTIVE	X	0	Disabled
0	X	1	X	Disabled
1	ACTIVE	1	1	Disabled
0	ACTIVE	0	0	Disabled

To remain in Boost Mode, the TMR_RST must be set by the host before the t_{32S} timer times out. If t_{32S} times out in Boost Mode; the IC resets all registers, pulses the STAT pin, sets the FAULT bits to 110, and resets the BOOST bit. VBUS POR or reading R0 clears the fault condition.

Boost PWM Control

The IC uses a minimum on–time and computed minimum off– time to regulate V_{BUS}. The regulator achieves excellent transient response by employing current–mode modulation. This technique causes the regulator to exhibit a load line.

During PWM Mode, the output voltage drops slightly as the input current rises. With a constant V_{BAT}, this appears as a constant output resistance.

The “droop” caused by the output resistance when a load is applied allows the regulator to respond smoothly to load transients with no undershoot from the load line. This can be seen in Figure 31 and Figure 40.

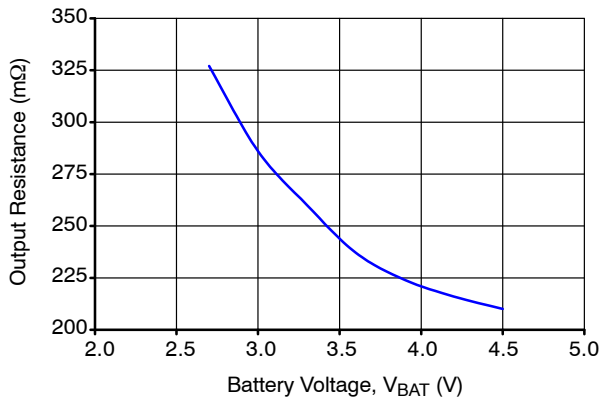

Figure 40. Output Resistance (R_{OUT})

V_{BUS} as a function of I_{LOAD} can be computed when the regulator is in PWM Mode (continuous conduction) as:

$$V_{OUT} = 5.07 - R_{OUT} \cdot I_{LOAD} \tag{eq. 1}$$

At V_{BAT} = 3.3 V, and I_{LOAD} = 200 mA, V_{BUS} would drop to:

$$V_{OUT} = 5.07 - 0.26 \cdot 0.2 = 5.018 \text{ V} \tag{eq. 2}$$

At V_{BAT} = 2.7 V, and I_{LOAD} = 200 mA, V_{BUS} would drop to:

$$V_{OUT} = 5.07 - 0.327 \cdot 0.2 = 5.005 \text{ V} \tag{eq. 3}$$

PFM Mode

If V_{BUS} > V_{REFBOOST} (nominally 5.07 V) when the minimum off–time has ended, the regulator enters PFM Mode. Boost pulses are inhibited until V_{BUS} < V_{REFBOOST}. The minimum on–time is increased to enable the output to pump up sufficiently with each PFM boost pulse. Therefore the regulator behaves like a constant on–time regulator, with the bottom of its output voltage ripple at 5.07 V in PFM Mode.

Table 17. Boost PWM Operating States

Mode	Description	Invoked When
LIN	Linear Startup	V _{BAT} > V _{BUS}
SS	Boost Soft–Start	V _{BUS} < V _{BST}
BST	Boost Operating Mode	V _{BAT} > UVLO _{BST} and SS Completed

Startup

When the boost regulator is shut down, current flow is prevented from V_{BAT} to V_{BUS}, as well as reverse flow from V_{BUS} to V_{BAT}.

LIN State

When EN rises, if V_{BAT} > UVLO_{BST}, the regulator first attempts to bring PMID within 400 mV of V_{BAT} using an internal 450 mA current source from V_{BAT} (LIN State). If PMID has not achieved V_{BAT} – 400 mV after 560 μs, a FAULT state is initiated.

SS State

When PMID > V_{BAT} – 400 mV, the boost regulator begins switching with a reduced peak current limit of about 50% of its normal current limit. The output slews up until V_{BUS} is within 5% of its setpoint; at which time, the regulation loop is closed and the current limit is set to 100%.

If the output fails to achieve 95% of its setpoint (V_{BST}) within 128 μs, the current limit is increased to 100%. If the output fails to achieve 95% of its setpoint after this second 384 μs period, a fault state is initiated.

BST State

This is the normal operating mode of the regulator. The regulator uses a minimum t_{OFF} – minimum t_{ON} modulation scheme. The minimum t_{OFF} is proportional to V_{IN} / V_{OUT}, which keeps the regulator’s switching frequency reasonably constant in CCM. t_{ON(MIN)} is proportional to V_{BAT} and is a higher value if the inductor current reached 0 before t_{OFF(MIN)} in the prior cycle.

To ensure the V_{BUS} does not pump significantly above the regulation point, the boost switch remains off as long as FB > V_{REF}.

Boost Faults

If a BOOST fault occurs:

1. The STAT pin pulses.
2. OPA_MODE bit is reset.
3. The power stage is in High–Impedance Mode.
4. The FAULT bits (REG0[2:0]) are set per Table 18.

Restart After Boost Faults

If boost was enabled with the OPA_MODE bit and OTG_EN = 0, Boost Mode can only be enabled through subsequent I²C commands since OPA_MODE is reset on boost faults. If OTG_EN = 1 and the OTG pin is still ACTIVE (see Table 16), the boost restarts after a 5.2 ms delay, as shown in Figure 41. If the fault condition persists, restart is attempted every 5 ms until the fault clears or an I²C command disables the boost.

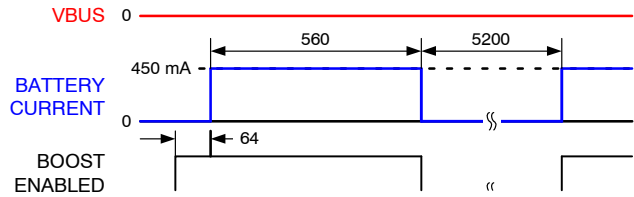

Figure 41. Boost Response Attempting to Start into V_{BUS} Short Circuit (Times in μs)

Table 18. FAULT BITS DURING BOOST MODE

Fault Bit			Fault Description
B2	B1	B0	
0	0	0	Normal (no fault)
0	0	1	V _{BUS} > V _{BUSOV} P
0	1	0	V _{BUS} fails to achieve the voltage required to advance to the next state during soft-start or sustained (>50 μs) current limit during the BST state.
0	1	1	V _{BAT} < UVLO _{BST}
1	0	0	N/A: This code does not appear.
1	0	1	Thermal shutdown
1	1	0	Timer fault; all registers reset.
1	1	1	N/A: This code does not appear.

VREG Pin

The 1.8 V regulated output on this pin can be disabled through I²C by setting the DIS_VREG bit (REG5[6]). VREG can supply up to 2 mA. This circuit, which is powered from PMID, is enabled only when PMID > V_{BAT} and does not drain current from the battery. During boost, V_{REG} is off. It is also off when the HZ_MODE bit (REG1[1]) = 1.

Monitor Register (Reg10H)

Additional status monitoring bits enable the host processor to have more visibility into the status of the IC. The monitor bits are real-time status indicators and are not internally debounced or otherwise time qualified.

The state of the MONITOR register bits listed in High-Impedance Mode is only valid when V_{BUS} is valid.

Table 19. MONITOR REGISTER BIT DEFINITIONS

BIT#	NAME	STATE		Active When
		0	1	
MONITOR Address 10H				
7	ITERM_CMP	V _{CSIN} - V _{BAT} < V _{ITERM}	V _{CSIN} - V _{BAT} > V _{ITERM}	Charging with TE = 1
		V _{CSIN} - V _{BAT} < 1 mV	V _{CSIN} - V _{BAT} > 1mV	Charging with TE = 0
6	VBAT_CMP	V _{BAT} < V _{SHORT}	V _{BAT} > V _{SHORT}	Charging
		V _{BAT} < V _{LOWV}	V _{BAT} > V _{LOWV}	High-Impedance Mode
		V _{BAT} < UVLO _{BST}	V _{BAT} > UVLO _{BST}	Boosting
5	LINCHG	Linear Charging Not Enabled	Linear Charging Enabled	Charging
4	T_120	T _J < 120°C	T _J > 120°C	
3	ICHG	Charging Current Controlled by I _{CHARGE} Control Loop	Charging Current Not Controlled by I _{CHARGE} Control Loop	Charging
2	IBUS	I _{BUS} Limiting Charging Current	Charge Current Not Limited by I _{BUS}	Charging
1	VBUS_VALID	V _{BUS} Not Valid	V _{BUS} is Valid	V _{BUS} > V _{BAT}
0	CV	Constant Current Charging	Constant Voltage Charging	Charging

I²C INTERFACE

The FAN54015’s serial interface is compatible with Standard, Fast, Fast Plus, and High-Speed Mode I²C-Bus specifications. The SCL line is an input and the SDA line is a bi-directional open-drain output; it can only pull down the bus when active. The SDA line only pulls LOW during data reads and signaling ACK. All data is shifted in MSB (bit 7) first.

Slave Address

Table 20. I²C SLAVE ADDRESS BYTE

Part Type	7	6	5	4	3	2	1	0
FAN54015	1	1	0	1	0	1	0	R/W

In hex notation, the slave address assumes a 0 LSB. The hex slave address for the FAN54015 is D4H and is D6H for all other parts in the family.

Bus Timing

As shown in Figure 42, data is normally transferred when SCL is LOW. Data is clocked in on the rising edge of SCL. Typically, data transitions shortly at or after the falling edge of SCL to allow ample time for the data to set up before the

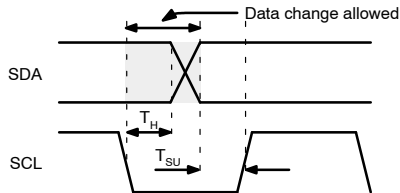

Figure 42. Data Transfer Timing

Each bus transaction begins and ends with SDA and SCL HIGH. A transaction begins with a START condition, which is defined as SDA transitioning from 1 to 0 with SCL HIGH, as shown in Figure 43.

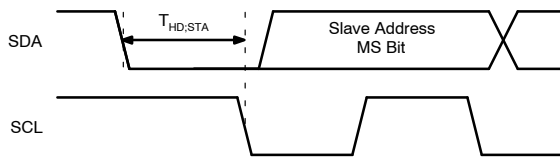

Figure 43. Start Bit

A transaction ends with a STOP condition, which is defined as SDA transitioning from 0 to 1 with SCL HIGH, as shown in Figure 44.

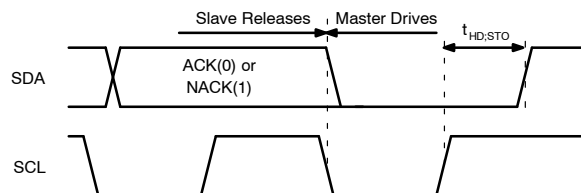

Figure 44. Stop Bit

During a read from the FAN54015 (Figure 46, Figure 47), the master issues a Repeated Start after sending the register address and before resending the slave address. The Repeated Start is a 1-to-0 transition on SDA while SCL is HIGH, as shown in Figure 45.

High-Speed (HS) Mode

The protocols for High-Speed (HS), Low-Speed (LS), and Fast-Speed (FS) Modes are identical except the bus speed for HS Mode is 3.4 MHz. HS Mode is entered when the bus master sends the HS master code 00001XXX after a start condition. The master code is sent in Fast or Fast Plus Mode (less than 1 MHz clock); slaves do not ACK this transmission.

The master then generates a repeated start condition (Figure 45) that causes all slaves on the bus to switch to HS Mode. The master then sends I²C packets, as described above, using the HS Mode clock rate and timing.

The bus remains in HS Mode until a stop bit (Figure 44) is sent by the master. While in HS Mode, packets are separated by repeated start conditions (Figure 45).

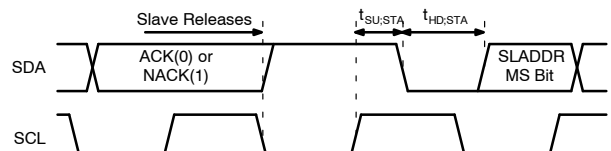

Figure 45. Repeated Start Timing

Read and Write Transactions

The figures below outline the sequences for data read and write. Bus control is signified by the shading of the packet, defined as Master Drives Bus and Slave Drives Bus. All addresses and data are MSB first.

Table 21. BIT DEFINITIONS FOR FIGURE 46, FIGURE 47, AND FIGURE 48

Symbol	Definition
S	START, see Figure 43
A	ACK. The slave drives SDA to 0 to acknowledge the preceding packet.
\bar{A}	NACK. The slave sends a 1 to NACK the preceding packet.
R	Repeated START, see Figure 45
P	STOP, see Figure 44. Figure 44

FAN54015

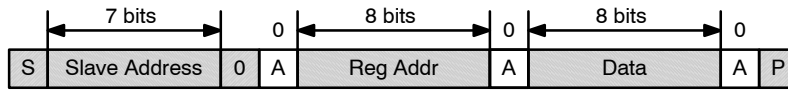

Figure 46. Write Transaction

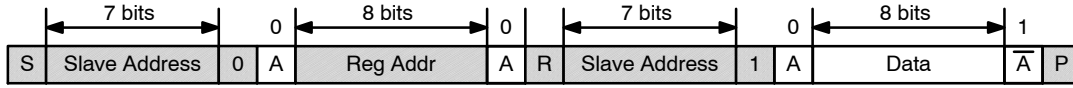

Figure 47. Read Transaction

REGISTER DESCRIPTIONS

The nine FAN54015 user-accessible registers are defined in Table 22.

Table 22. I²C REGISTER ADDRESS

Register		Address Bits							
Name	REG#	7	6	5	4	3	2	1	0
CONTROL0	0	0	0	0	0	0	0	0	0
CONTROL1	1	0	0	0	0	0	0	0	1
OREG	2	0	0	0	0	0	0	1	0
IC_INFO	03 or 3BH	0	0	0	0	0	0	1	1
IBAT	4	0	0	0	0	0	1	0	0
SP_CHARGER	5	0	0	0	0	0	1	0	1
SAFETY	6	0	0	0	0	0	1	1	0
MONITOR	10h	0	0	0	1	0	0	0	0

Table 23. REGISTER BIT DEFINITIONS

(This table defines the operation of each register bit for all IC versions. Default values are in **bold** text.)

Bit	Name	Value	Type	Description
CONTROL0 Register Address: 00 Default Value = X1XX 0XXX				
7	TMR_RST OTG	1	W	Writing a 1 resets the t_{32S} timer; writing a 0 has no effect
			R	Returns the OTG pin level (1 = HIGH)
6	EN_STAT	0	R/W	Prevents STAT pin from going LOW during charging; STAT pin still pulses to enunciate faults
			1	Enables STAT pin LOW when IC is charging
5:4	STAT	00	R	Ready
			01	Charge in progress
			10	Charge done
			11	Fault
3	BOOST	0	R	IC is not in Boost Mode
			1	IC is in Boost Mode
2:0	FAULT		R	Fault status bits: <i>for Charge Mode, see Table 13; for Boost Mode, see Table 18</i>
CONTROL1 Register Address: 01 Default Value = 0011 0000 (30h)				
7:6	IINLIM		R/W	Input current limit, <i>see Table 7</i>
5:4	VLOWV	00	R/W	3.4 V
			01	3.5 V
			10	3.6 V
			11	3.7 V
				Weak battery voltage threshold

FAN54015

Table 23. REGISTER BIT DEFINITIONS

(This table defines the operation of each register bit for all IC versions. Default values are in **bold text**.) (continued)

Bit	Name	Value	Type	Description	
CONTROL1 Register Address: 01 Default Value = 0011 0000 (30h)					
3	TE	0	R/W	Disable charge current termination	
		1		Enable charge current termination	
2	\overline{CE}	0	R/W	Charger enabled	
		1		Charger disabled	
1	HZ_MODE	0	R/W	Not High-Impedance Mode	See Table 16
		1		High-Impedance Mode	
0	OPA_MODE	0	R/W	Charge Mode	
		1		Boost Mode	
OREG Register Address: 02 Default Value = 0000 1010 (0Ah)					
7:2	OREG		R/W	Charger output “float” voltage; programmable from 3.5 to 4.4V in 20mV increments; defaults to 000010 (3.54 V) , see Table 3	
1	OTG_PL	0	R/W	OTG pin active LOW	
		1		OTG pin active HIGH	
0	OTG_EN	0	R/W	Disables OTG pin	
		1		Enables OTG pin	
IC_INFO Register Address: 03 Default Value = 10010100 (94h)					
7:5	Vendor Code	100	R	Identifies ON Semiconductor as the IC supplier	
4:2	PN		R	Part number bits, see the Ordering Info on page 31	
1:0	REV	00	R	IC Revision, revision 1.X, where X is the decimal of these three bits	
IBAT Register Address: 04 Default Value = 1000 1001 (89h)					
7	RESET	1	W	Writing a 1 resets charge parameters, except the Safety register (Reg6), to their defaults: writing a 0 has no effect; read returns 1	
6:4	IOCHARGE	Table 5	R/W	Programs the maximum charge current, see Table 5	
3	Reserved	1	R	Unused	
2:0	ITERM	Table 6	R/W	Sets the current used for charging termination, see Table 6	
SP_CHARGER Register Address: 05 Default Value = 001X X100					
7	Reserved	0	R	Unused	
6	DIS_VREG	0	R/W	1.8 V regulator is ON	
		1		1.8 V regulator is OFF	
5	IO_LEVEL	0	R/W	Output current is controlled by IOCHARGE bits	
		1		Voltage across R _{SENSE} for output current control is set to 34 mV (500 mA for R _{SENSE} = 68 mΩ and 340 mA for 100 mΩ)	
4	SP	0	R	Special charger is not active (V _{BUS} is able to stay above V _{SP})	
		1		Special charger has been detected and V _{BUS} is being regulated to V _{SP}	
3	EN_LEVEL	0	R	DISABLE pin is LOW	
		1		DISABLE pin is HIGH	
2:0	VSP	Table 8	R/W	Special charger input regulation voltage, see Table 8	
SAFETY Register Address: 06 Default Value = 0100 0000 (40h)					
7	Reserved	0	R	Bit disabled and always returns 0 when read back	
6:4	ISAFE	Table 9	R/W	Sets the maximum I _{IOCHARGE} value used by the control circuit, see Table 9	
3:0	VSAFE	Table 10	R/W	Sets the maximum V _{OREG} used by the control circuit, see Table 10	

Table 23. REGISTER BIT DEFINITIONS

(This table defines the operation of each register bit for all IC versions. Default values are in **bold text**.) (continued)

Bit	Name	Value	Type	Description
MONITOR		Register Address: 10h (16)		<i>See Table 19</i>
7	ITERM_CMP	See Table 19	R	ITERM comparator output, 1 when VRSENSE > ITERM reference
6	VBAT_CMP		R	Output of VBAT comparator
5	LINCHG		R	30 mA linear charger ON
4	T_120		R	Thermal regulation comparator; when = 1 and T_145 = 0, the charge current is limited to 22.1 mV across RSENSE
3	ICHG		R	0 indicates the ICHARGE loop is controlling the battery charge current
2	IBUS		R	0 indicates the IBUS (input current) loop is controlling the battery charge current
1	VBUS_VALID		R	1 indicates VBUS has passed validation and is capable of charging
0	CV		R	1 indicates the constant-voltage loop (OREG) is controlling the charger and all current limiting loops have released

PCB LAYOUT RECOMMENDATIONS

Bypass capacitors should be placed as close to the IC as possible. In particular, the total loop length for CMID should be minimized to reduce overshoot and ringing on the SW,

PMID, and VBUS pins. All power and ground pins must be routed to their bypass capacitors, using top copper whenever possible. Copper area connecting to the IC should be maximized to improve thermal performance if possible.

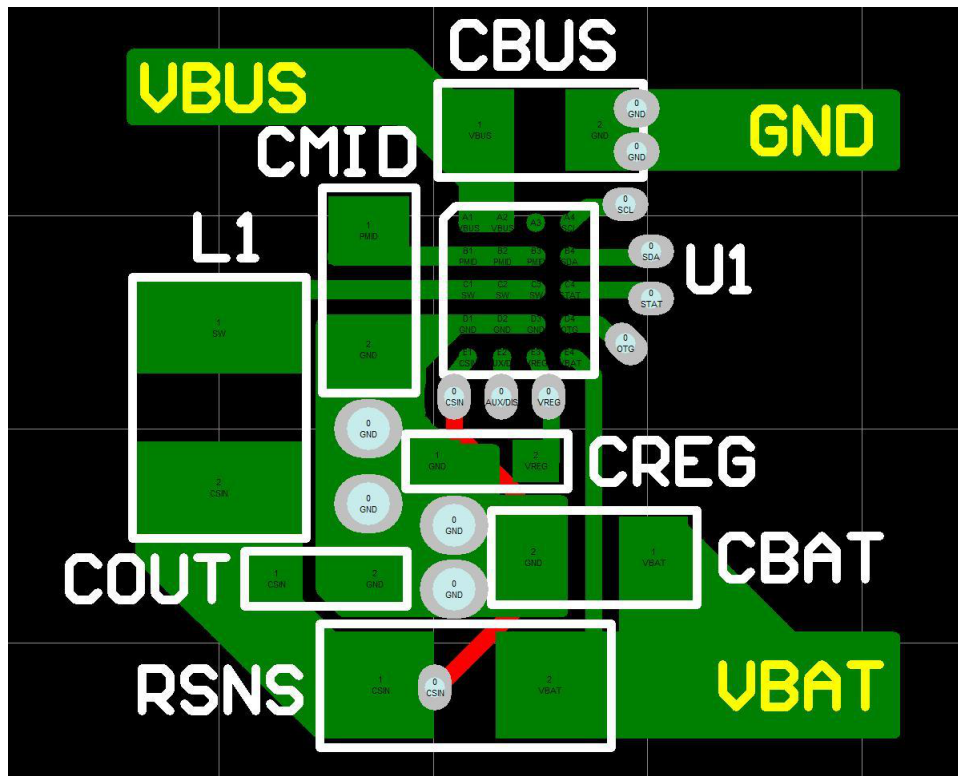

Figure 48. PCB Layout Recommendations

FAN54015

ORDERING INFORMATION

Part Number	Temperature Range	Package	PN Bits: IC_INFO[4:2]	Shipping [†]
FAN54015UCX	-40 to 85°C	20-Bump, Wafer-Level Chip-Scale Package (WLCSP), 0.4 mm Pitch, Estimated Size: 1.96 x 1.87 mm (Pb-Free)	101	3000 / Tape & Reel
FAN54015BUCX (Note 8)				3000 / Tape & Reel

[†]For information on tape and reel specifications, including part orientation and tape sizes, please refer to our Tape and Reel Packaging Specifications Brochure, BRD8011/D.

8. FAN54015BUCX includes backside lamination.

WLCSP20 1.96x1.87x0.586
CASE 567SL
ISSUE O

DATE 30 NOV 2016

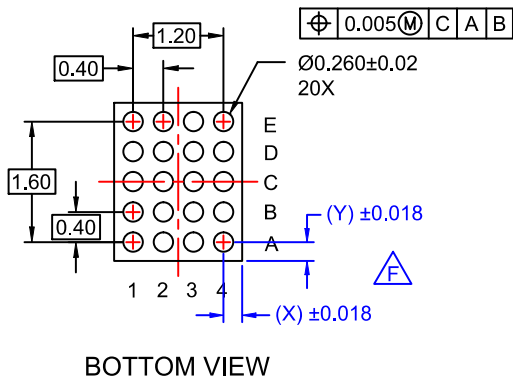
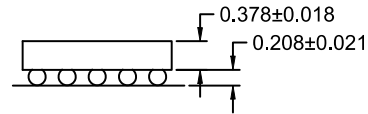
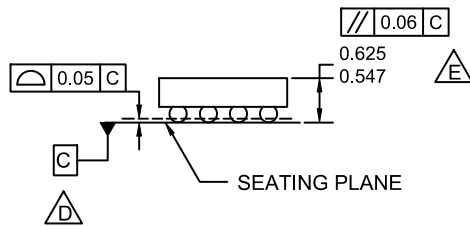
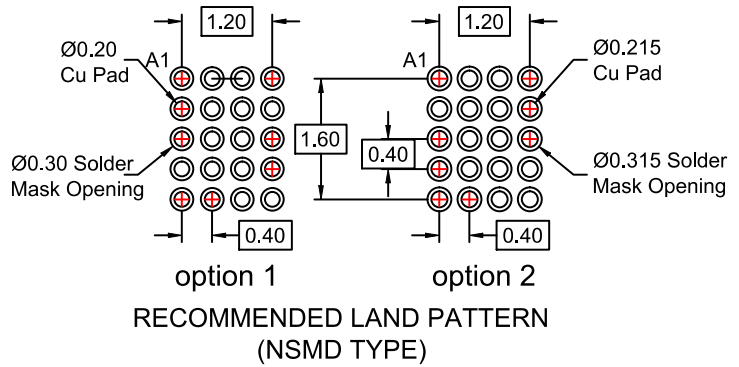
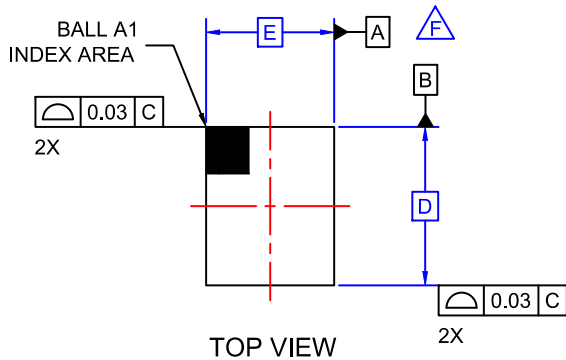

NOTES:

- A. NO JEDEC REGISTRATION APPLIES.
- B. DIMENSIONS ARE IN MILLIMETERS.
- C. DIMENSIONS AND TOLERANCE PER ASMEY14.5M, 2009.
- D.** DATUM C IS DEFINED BY THE SPHERICAL CROWNS OF THE BALLS.
- E.** PACKAGE NOMINAL HEIGHT IS 586 MICRONS ±39 MICRONS (547-625 MICRONS).
- F.** FOR DIMENSIONS D, E, X, AND Y SEE PRODUCT DATASHEET.

DOCUMENT NUMBER:	98AON16608G	Electronic versions are uncontrolled except when accessed directly from the Document Repository. Printed versions are uncontrolled except when stamped "CONTROLLED COPY" in red.
DESCRIPTION:	WLCSP20 1.96x1.87x0.586	PAGE 1 OF 1

ON Semiconductor and are trademarks of Semiconductor Components Industries, LLC dba ON Semiconductor or its subsidiaries in the United States and/or other countries. ON Semiconductor reserves the right to make changes without further notice to any products herein. ON Semiconductor makes no warranty, representation or guarantee regarding the suitability of its products for any particular purpose, nor does ON Semiconductor assume any liability arising out of the application or use of any product or circuit, and specifically disclaims any and all liability, including without limitation special, consequential or incidental damages. ON Semiconductor does not convey any license under its patent rights nor the rights of others.

onsemi, **Onsemi**, and other names, marks, and brands are registered and/or common law trademarks of Semiconductor Components Industries, LLC dba "**onsemi**" or its affiliates and/or subsidiaries in the United States and/or other countries. **onsemi** owns the rights to a number of patents, trademarks, copyrights, trade secrets, and other intellectual property. A listing of **onsemi**'s product/patent coverage may be accessed at www.onsemi.com/site/pdf/Patent-Marking.pdf. **onsemi** reserves the right to make changes at any time to any products or information herein, without notice. The information herein is provided "as-is" and **onsemi** makes no warranty, representation or guarantee regarding the accuracy of the information, product features, availability, functionality, or suitability of its products for any particular purpose, nor does **onsemi** assume any liability arising out of the application or use of any product or circuit, and specifically disclaims any and all liability, including without limitation special, consequential or incidental damages. Buyer is responsible for its products and applications using **onsemi** products, including compliance with all laws, regulations and safety requirements or standards, regardless of any support or applications information provided by **onsemi**. "Typical" parameters which may be provided in **onsemi** data sheets and/or specifications can and do vary in different applications and actual performance may vary over time. All operating parameters, including "Typicals" must be validated for each customer application by customer's technical experts. **onsemi** does not convey any license under any of its intellectual property rights nor the rights of others. **onsemi** products are not designed, intended, or authorized for use as a critical component in life support systems or any FDA Class 3 medical devices or medical devices with a same or similar classification in a foreign jurisdiction or any devices intended for implantation in the human body. Should Buyer purchase or use **onsemi** products for any such unintended or unauthorized application, Buyer shall indemnify and hold **onsemi** and its officers, employees, subsidiaries, affiliates, and distributors harmless against all claims, costs, damages, and expenses, and reasonable attorney fees arising out of, directly or indirectly, any claim of personal injury or death associated with such unintended or unauthorized use, even if such claim alleges that **onsemi** was negligent regarding the design or manufacture of the part. **onsemi** is an Equal Opportunity/Affirmative Action Employer. This literature is subject to all applicable copyright laws and is not for resale in any manner.

PUBLICATION ORDERING INFORMATION

LITERATURE FULFILLMENT:

Email Requests to: orderlit@onsemi.com

onsemi Website: www.onsemi.com

TECHNICAL SUPPORT

North American Technical Support:

Voice Mail: 1 800-282-9855 Toll Free USA/Canada

Phone: 011 421 33 790 2910

Europe, Middle East and Africa Technical Support:

Phone: 00421 33 790 2910

For additional information, please contact your local Sales Representative