

# DATA SHEET

## SURFACE-MOUNT CERAMIC MULTILAYER CAPACITORS

General Purpose & High Capacitance

Class 2, X7R

6.3 V TO 250 V

100 pF to 47  $\mu$ F

RoHS compliant & Halogen Free



SCOPE

This specification describes X7R series chip capacitors with lead-free terminations.

APPLICATIONS

- PCs, Hard disk, Game PCs
- DVDs, Video cameras
- Mobile phones
- Data processing

FEATURES

- Supplied in tape on reel
- Nickel-barrier end termination
- RoHS compliant
- Halogen Free compliant

ORDERING INFORMATION - GLOBAL PART NUMBER, PHYCOMP

CTC & I2NC

All part numbers are identified by the series, size, tolerance, TC material, packing style, voltage, process code, termination and capacitance value.

**YAGEO BRAND ordering code**

**GLOBAL PART NUMBER (PREFERRED)**

**CC** XXXX X X **X7R** X **BB** XXX  
 (1) (2) (3) (4) (5)

---

**(1) SIZE – INCH BASED (METRIC)**

- 0201 (0603)
- 0402 (1005)
- 0603 (1608)
- 0805 (2012)
- 1206 (3216)
- 1210 (3225)
- 1812 (4532)
- 2220 (5750)

---

**(2) TOLERANCE**

- J = ±5% <sup>(1)</sup>
- K = ±10%
- M = ±20%

---

**(3) PACKING STYLE**

- R = Paper/PE taping reel; Reel 7 inch
- K = Blister taping reel; Reel 7 inch
- P = Paper/PE taping reel; Reel 13 inch
- F = Blister taping reel; Reel 13 inch

---

**(4) RATED VOLTAGE**

- 5 = 6.3 V                      0 = 100 V
- 6 = 10 V                      A = 200 V
- 7 = 16 V                      Y = 250 V
- 8 = 25 V
- 9 = 50 V

---

**(5) CAPACITANCE VALUE**

2 significant digits+number of zeros  
 The 3rd digit signifies the multiplying factor, and letter R is decimal point  
 Example: 103 = 10 × 10<sup>3</sup> = 10,000 pF = 10 nF

**NOTE**

1. Tolerance ±5% is not available for full product range, please contact local sales force before ordering

**CONSTRUCTION**

The capacitor consists of a rectangular block of ceramic dielectric in which a number of interleaved metal electrodes are contained. This structure gives rise to a high capacitance per unit volume.

The inner electrodes are connected to the two end terminations and finally covered with a layer of plated tin (NiSn). The terminations are lead-free. A cross section of the structure is shown in Fig.1.

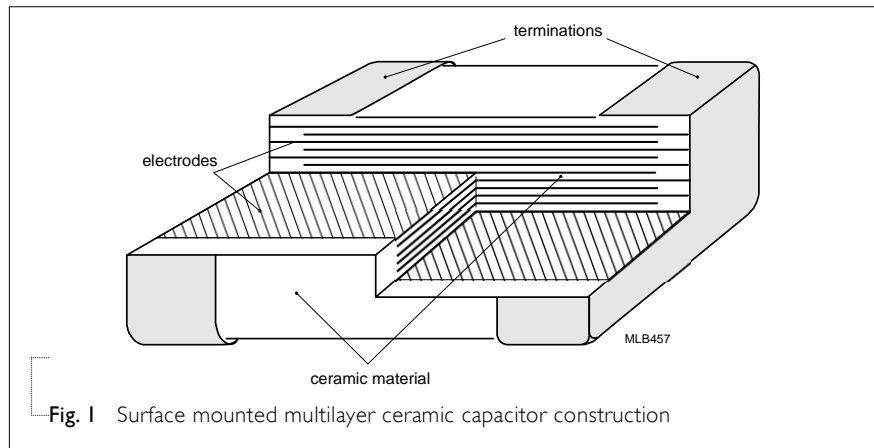

Fig. 1 Surface mounted multilayer ceramic capacitor construction

**DIMENSION**

Table I For outlines see fig. 2

| TYPE | L <sub>1</sub> (mm) | W (mm)    | T (mm)    | L <sub>2</sub> / L <sub>3</sub> (mm) |      | L <sub>4</sub> (mm) | DIMENSION CODE |
|------|---------------------|-----------|-----------|--------------------------------------|------|---------------------|----------------|
|      |                     |           |           | min.                                 | Max. |                     |                |
| 0201 | 0.6 ±0.03           | 0.3 ±0.03 | 0.3 ±0.03 | 0.1                                  | 0.2  | 0.2                 | BA             |
| 0402 | 1.0 ±0.05           | 0.5 ±0.05 | 0.5 ±0.05 | 0.15                                 | 0.35 | 0.3                 | CA             |
|      | 1.0 ±0.20           | 0.5 ±0.20 | 0.5 ±0.20 | 0.15                                 | 0.35 | 0.3                 | CD             |
| 0603 | 1.6 ±0.1            | 0.8 ±0.1  | 0.8 ±0.1  | 0.2                                  | 0.6  | 0.4                 | DA             |
|      | 1.6 ±0.15           | 0.8 ±0.15 | 0.8 ±0.15 | 0.2                                  | 0.6  | 0.4                 | DB             |
|      | 1.6 ±0.2            | 0.8 ±0.2  | 0.8 ±0.2  | 0.2                                  | 0.6  | 0.4                 | DC             |
| 0805 | 2.0 ±0.1            | 1.25 ±0.1 | 0.6 ±0.1  | 0.25                                 | 0.75 | 0.7                 | E0             |
|      | 2.0 ±0.2            | 1.25 ±0.2 | 0.85 ±0.1 | 0.25                                 | 0.75 | 0.7                 | EA             |
|      | 2.0 ±0.2            | 1.25 ±0.2 | 1.25 ±0.2 | 0.25                                 | 0.75 | 0.7                 | EB             |
| 1206 | 3.2 ±0.15           | 1.6 ±0.15 | 0.85 ±0.1 | 0.25                                 | 0.75 | 1.4                 | F0             |
|      | 3.2 ±0.2            | 1.6 ±0.2  | 1.0 ±0.1  | 0.25                                 | 0.75 | 1.4                 | F1             |
|      | 3.2 ±0.2            | 1.6 ±0.2  | 1.15 ±0.1 | 0.25                                 | 0.75 | 1.4                 | FA             |
|      | 3.2 ±0.3            | 1.6 ±0.2  | 1.6 ±0.2  | 0.25                                 | 0.75 | 1.4                 | FB             |
|      | 3.2 ±0.3            | 1.6 ±0.2  | 1.6 ±0.2  | 0.25                                 | 0.8  | 1.4                 | FC             |
|      | 3.2 ±0.3            | 1.6 ±0.3  | 1.6 ±0.3  | 0.3                                  | 0.9  | 1.4                 | FD             |
| 1210 | 3.2 ±0.2            | 2.5 ±0.2  | 0.85 ±0.1 | 0.25                                 | 0.75 | 1.4                 | G0             |
|      | 3.2 ±0.4            | 2.5 ±0.3  | 1.25 ±0.2 | 0.25                                 | 0.75 | 1.4                 | GA             |
|      | 3.2 ±0.4            | 2.5 ±0.3  | 1.6 ±0.2  | 0.25                                 | 0.75 | 1.4                 | G2             |
|      | 3.2 ±0.4            | 2.5 ±0.3  | 1.9 ±0.2  | 0.25                                 | 0.75 | 1.4                 | GB             |
|      | 3.2 ±0.4            | 2.5 ±0.3  | 2.0 ±0.2  | 0.25                                 | 0.75 | 1.4                 | G3             |
|      | 3.2 ±0.4            | 2.5 ±0.3  | 2.5 ±0.2  | 0.25                                 | 0.75 | 1.0                 | GC             |
| 1812 | 4.5 ±0.2            | 3.2 ±0.2  | 0.85 ±0.1 | 0.25                                 | 0.75 | 2.2                 | JA             |
|      | 4.5 ±0.2            | 3.2 ±0.2  | 1.25 ±0.1 | 0.25                                 | 0.75 | 2.2                 | JB             |
|      | 4.5 ±0.4            | 3.2 ±0.4  | 1.6 ±0.2  | 0.25                                 | 0.75 | 2.2                 | JC             |
| 2220 | 5.7±0.4             | 5.0±0.3   | 1.15±0.1  | 0.25                                 | 0.75 | 3.8                 | KA             |

**OUTLINES**

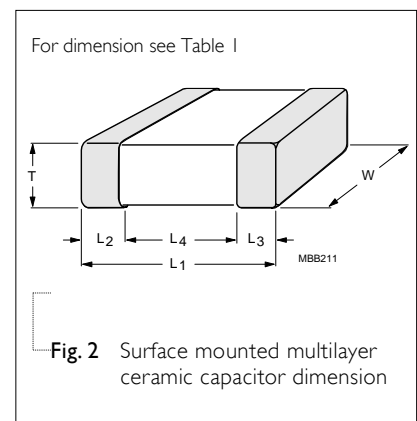

Fig. 2 Surface mounted multilayer ceramic capacitor dimension

**CAPACITANCE RANGE & THICKNESS FOR X7R**

**Table 2** Sizes from 0201 to 0402

| CAP.   | 0201  |      |      |      |      | 0402  |      |      |      |      |       |  |
|--------|-------|------|------|------|------|-------|------|------|------|------|-------|--|
|        | 6.3 V | 10 V | 16 V | 25 V | 50 V | 6.3 V | 10 V | 16 V | 25 V | 50 V | 100 V |  |
| 100 pF | BA    | BA   | BA   | BA   | BA   | CA    | CA   | CA   | CA   | CA   | CA    |  |
| 150 pF | BA    | BA   | BA   | BA   | BA   | CA    | CA   | CA   | CA   | CA   | CA    |  |
| 220 pF | BA    | BA   | BA   | BA   | BA   | CA    | CA   | CA   | CA   | CA   | CA    |  |
| 330 pF | BA    | BA   | BA   | BA   | BA   | CA    | CA   | CA   | CA   | CA   | CA    |  |
| 470 pF | BA    | BA   | BA   | BA   | BA   | CA    | CA   | CA   | CA   | CA   | CA    |  |
| 680 pF | BA    | BA   | BA   | BA   | BA   | CA    | CA   | CA   | CA   | CA   | CA    |  |
| 1.0 nF | BA    | BA   | BA   | BA   | BA   | CA    | CA   | CA   | CA   | CA   | CA    |  |
| 1.5 nF | BA    | BA   | BA   | BA   |      | CA    | CA   | CA   | CA   | CA   | CA    |  |
| 2.2 nF | BA    | BA   | BA   | BA   |      | CA    | CA   | CA   | CA   | CA   | CA    |  |
| 3.3 nF | BA    | BA   | BA   | BA   |      | CA    | CA   | CA   | CA   | CA   | CA    |  |
| 4.7 nF | BA    | BA   | BA   | BA   |      | CA    | CA   | CA   | CA   | CA   | CA    |  |
| 6.8 nF | BA    | BA   | BA   | BA   |      | CA    | CA   | CA   | CA   | CA   | CA    |  |
| 10 nF  | BA    | BA   | BA   | BA   |      | CA    | CA   | CA   | CA   | CA   | CA    |  |
| 15 nF  |       |      |      |      |      | CA    | CA   | CA   | CA   | CA   |       |  |
| 22 nF  | BA    |      |      |      |      | CA    | CA   | CA   | CA   | CA   |       |  |
| 33 nF  | BA    |      |      |      |      | CA    | CA   | CA   | CA   | CA   |       |  |
| 47 nF  | BA    |      |      |      |      | CA    | CA   | CA   | CA   | CA   |       |  |
| 68 nF  |       |      |      |      |      | CA    | CA   | CA   | CA   | CA   |       |  |
| 100 nF | BA    |      |      |      |      | CA    | CA   | CA   | CA   | CA   |       |  |
| 150 nF |       |      |      |      |      |       |      | CA   | CA   |      |       |  |
| 220 nF |       |      |      |      |      | CA    | CA   | CA   | CA   |      |       |  |
| 330 nF |       |      |      |      |      |       |      |      |      |      |       |  |
| 470 nF |       |      |      |      |      | CA    | CA   |      |      |      |       |  |
| 680 nF |       |      |      |      |      |       |      |      |      |      |       |  |
| 1 μF   |       |      |      |      |      | CA    | CA   |      |      |      |       |  |
| 2.2 μF |       |      |      |      |      | CD    |      |      |      |      |       |  |

**NOTE**

1. Values in shaded cells indicate thickness class in mm
2. Capacitance value of non E-6 series is on request
3. For product with 5% tolerance, please contact local sales force before ordering

| CASE SIZE | L (mm)    | W (mm)    | T (mm)    | DIMENSION CODE |
|-----------|-----------|-----------|-----------|----------------|
| 0201      | 0.6 ±0.03 | 0.3 ±0.03 | 0.3 ±0.03 | BA             |
| 0402      | 1.0 ±0.05 | 0.5 ±0.05 | 0.5 ±0.05 | CA             |
|           | 1.0 ±0.20 | 0.5 ±0.20 | 0.5 ±0.20 | CD             |

**CAPACITANCE RANGE & THICKNESS FOR X7R**

**Table 3** Sizes from 0603

| CAP.   | 0603  |      |      |      |      |      |      |      |  |
|--------|-------|------|------|------|------|------|------|------|--|
|        | 6.3 V | 10 V | 16 V | 25 V | 50 V | 100V | 200V | 250V |  |
| 100 pF | DA    | DA   | DA   | DA   | DA   | DA   |      |      |  |
| 150 pF | DA    | DA   | DA   | DA   | DA   | DA   |      |      |  |
| 220 pF | DA    | DA   | DA   | DA   | DA   | DA   | DA   | DA   |  |
| 330 pF | DA    | DA   | DA   | DA   | DA   | DA   | DA   | DA   |  |
| 470 pF | DA    | DA   | DA   | DA   | DA   | DA   | DA   | DA   |  |
| 680 pF | DA    | DA   | DA   | DA   | DA   | DA   | DA   | DA   |  |
| 1.0 nF | DA    | DA   | DA   | DA   | DA   | DA   | DA   | DA   |  |
| 1.5 nF | DA    | DA   | DA   | DA   | DA   | DA   | DA   | DA   |  |
| 2.2 nF | DA    | DA   | DA   | DA   | DA   | DA   | DA   | DA   |  |
| 3.3 nF | DA    | DA   | DA   | DA   | DA   | DA   | DA   | DA   |  |
| 4.7 nF | DA    | DA   | DA   | DA   | DA   | DA   | DA   | DA   |  |
| 6.8 nF | DA    | DA   | DA   | DA   | DA   | DA   | DA   | DA   |  |
| 10 nF  | DA    | DA   | DA   | DA   | DA   | DA   | DA   | DA   |  |
| 15 nF  | DA    | DA   | DA   | DA   | DA   | DA   | DA   | DA   |  |
| 22 nF  | DA    | DA   | DA   | DA   | DA   | DA   | DA   | DA   |  |
| 33 nF  | DA    | DA   | DA   | DA   | DA   | DA   |      |      |  |
| 47 nF  | DA    | DA   | DA   | DA   | DA   | DA   |      |      |  |
| 68 nF  | DA    | DA   | DA   | DA   | DA   | DA   |      |      |  |
| 100 nF | DA    | DA   | DA   | DA   | DA   | DA   |      |      |  |
| 150 nF | DA    | DA   | DA   | DA   | DA   |      |      |      |  |
| 220 nF | DA    | DA   | DA   | DA   | DA   |      |      |      |  |
| 330 nF | DA    | DA   | DA   | DA   |      |      |      |      |  |
| 470 nF | DA    | DA   | DA   | DA   | DA   |      |      |      |  |
| 680 nF | DA    | DA   | DA   | DA   | DB   |      |      |      |  |
| 1 μF   | DA    | DA   | DA   | DA   | DB   |      |      |      |  |
| 2.2 μF | DA    | DA   | DC   |      |      |      |      |      |  |
| 4.7 μF | DC    |      |      |      |      |      |      |      |  |

**NOTE**

1. Values in shaded cells indicate thickness class in mm
2. Capacitance value of non E-6 series is on request
3. For product with 5% tolerance, please contact local sales force before ordering

| CASE SIZE | L (mm)    | W (mm)    | T (mm)    | DIMENSION CODE |
|-----------|-----------|-----------|-----------|----------------|
| 0603      | 1.6 ±0.1  | 0.8 ±0.1  | 0.8 ±0.1  | DA             |
|           | 1.6 ±0.15 | 0.8 ±0.15 | 0.8 ±0.15 | DB             |
|           | 1.6 ±0.2  | 0.8 ±0.2  | 0.8 ±0.2  | DC             |

**CAPACITANCE RANGE & THICKNESS FOR X7R**

Table 4 Sizes from 0805

| CAP.   | 0805  |      |      |      |      |      |      |      |
|--------|-------|------|------|------|------|------|------|------|
|        | 6.3 V | 10 V | 16 V | 25 V | 50 V | 100V | 200V | 250V |
| 100 pF | E0    | E0   | E0   | E0   | E0   | E0   | EA   | EA   |
| 150 pF | E0    | E0   | E0   | E0   | E0   | E0   | EA   | EA   |
| 220 pF | E0    | E0   | E0   | E0   | E0   | E0   | EA   | EA   |
| 330 pF | E0    | E0   | E0   | E0   | E0   | E0   | EA   | EA   |
| 470 pF | E0    | E0   | E0   | E0   | E0   | E0   | EA   | EA   |
| 680 pF | E0    | E0   | E0   | E0   | E0   | E0   | EA   | EA   |
| 1.0 nF | E0    | E0   | E0   | E0   | E0   | E0   | EA   | EA   |
| 1.5 nF | E0    | E0   | E0   | E0   | E0   | E0   | EA   | EA   |
| 2.2 nF | E0    | E0   | E0   | E0   | E0   | E0   | EA   | EA   |
| 3.3 nF | E0    | E0   | E0   | E0   | E0   | E0   | EB   | EB   |
| 4.7 nF | E0    | E0   | E0   | E0   | E0   | E0   | EB   | EB   |
| 6.8 nF | E0    | E0   | E0   | E0   | E0   | EA   | EB   | EB   |
| 10 nF  | E0    | E0   | E0   | E0   | E0   | EA   | EB   | EB   |
| 15 nF  | EA    | EA   | EA   | EA   | EA   | EB   | EB   | EB   |
| 22 nF  | EA    | EA   | EA   | EA   | EA   | EB   | EB   | EB   |
| 33 nF  | EA    | EA   | EA   | EA   | EA   | EB   | EB   | EB   |
| 47 nF  | EA    | EA   | EA   | EA   | EA   | EB   | EB   | EB   |
| 68 nF  | EA    | EA   | EA   | EA   | EA   | EB   |      |      |
| 100 nF | EA    | EA   | EA   | EA   | EA   | EB   |      |      |
| 150 nF | EA    | EA   | EA   | EA   | EA   | EB   |      |      |
| 220 nF | EB    | EB   | EB   | EB   | EB   | EB   |      |      |
| 330 nF | EB    | EB   | EB   | EB   | EB   | EB   |      |      |
| 470 nF | EB    | EB   | EB   | EB   | EB   | EB   |      |      |
| 680 nF | EB    | EB   | EB   | EB   | EB   | EB   |      |      |
| 1 μF   | EB    | EB   | EB   | EB   | EB   | EB   |      |      |
| 2.2 μF | EB    | EB   | EB   | EB   | EB   |      |      |      |
| 4.7 μF | EB    | EB   | EB   | EB   |      |      |      |      |
| 10 μF  | EB    | EB   | EB   |      |      |      |      |      |

**NOTE**

1. Values in shaded cells indicate thickness class in mm
2. Capacitance value of non E-6 series is on request
3. For product with 5% tolerance, please contact local sales force before ordering

| CASE SIZE | L (mm)   | W (mm)    | T (mm)    | DIMENSION CODE |
|-----------|----------|-----------|-----------|----------------|
| 0805      | 2.0 ±0.1 | 1.25 ±0.1 | 0.6 ±0.1  | E0             |
|           | 2.0 ±0.2 | 1.25 ±0.2 | 0.85 ±0.1 | EA             |
|           | 2.0 ±0.2 | 1.25 ±0.2 | 1.25 ±0.2 | EB             |

**CAPACITANCE RANGE & THICKNESS FOR X7R**

Table 5 Size 1206

| CAP.   | 1206  |      |      |      |      |      |      |      |
|--------|-------|------|------|------|------|------|------|------|
|        | 6.3 V | 10 V | 16 V | 25 V | 50 V | 100V | 200V | 250V |
| 220 pF | F0    | F0   | F0   | F0   | F0   | F0   | F0   | F0   |
| 330 pF | F0    | F0   | F0   | F0   | F0   | F0   | F0   | F0   |
| 470 pF | F0    | F0   | F0   | F0   | F0   | F0   | F0   | F0   |
| 680 pF | F0    | F0   | F0   | F0   | F0   | F0   | F0   | F0   |
| 1.0 nF | F0    | F0   | F0   | F0   | F0   | F0   | F0   | F0   |
| 1.5 nF | F0    | F0   | F0   | F0   | F0   | F0   | F0   | F0   |
| 2.2 nF | F0    | F0   | F0   | F0   | F0   | F0   | F0   | F0   |
| 3.3 nF | F0    | F0   | F0   | F0   | F0   | F0   | F0   | F0   |
| 4.7 nF | F0    | F0   | F0   | F0   | F0   | F0   | F0   | F0   |
| 6.8 nF | F0    | F0   | F0   | F0   | F0   | F0   | F0   | F0   |
| 10 nF  | F0    | F0   | F0   | F0   | F0   | F0   | F0   | F0   |
| 15 nF  | F0    | F0   | F0   | F0   | F0   | F0   | F0   | F0   |
| 22 nF  | F0    | F0   | F0   | F0   | F0   | F0   | FB   | FB   |
| 33 nF  | F0    | F0   | F0   | F0   | F0   | F0   | FB   | FB   |
| 47 nF  | F0    | F0   | F0   | F0   | F0   | F0   | FB   | FB   |
| 68 nF  | F0    | F0   | F0   | F0   | F0   | FB   | FB   | FB   |
| 100 nF | F0    | F0   | F0   | F0   | F0   | FB   | FC   | FC   |
| 150 nF | F0    | F0   | F0   | F0   | FA   | FB   |      |      |
| 220 nF | F0    | F0   | F0   | F0   | FA   | FB   |      |      |
| 330 nF | F0    | F0   | F0   | F0   | F0   | FC   |      |      |
| 470 nF | F0    | F0   | F0   | F0   | FI   | FC   |      |      |
| 680 nF | FA    | FA   | FA   | FA   | FC   | FC   |      |      |
| 1 μF   | FA    | FA   | FA   | FA   | FC   | FC   |      |      |
| 2.2 μF | FA    | FA   | FA   | FA   | FC   | FC   |      |      |
| 4.7 μF | FC    | FC   | FC   | FC   | FC   |      |      |      |
| 10 μF  | FC    | FC   | FC   | FC   |      |      |      |      |
| 22 μF  | FC    | FC   | FD   |      |      |      |      |      |

**NOTE**

1. Values in shaded cells indicate thickness class in mm
2. Capacitance value of non E-6 series is on request
3. For product with 5% tolerance, please contact local sales force before ordering
4. Please contact local sales force for special ordering code before ordering

| CASE SIZE | L (mm)    | W (mm)    | T (mm)    | DIMENSION CODE |
|-----------|-----------|-----------|-----------|----------------|
| 1206      | 3.2 ±0.15 | 1.6 ±0.15 | 0.85 ±0.1 | F0             |
|           | 3.2 ±0.2  | 1.6 ±0.2  | 1.0 ±0.1  | FI             |
|           | 3.2 ±0.2  | 1.6 ±0.2  | 1.15 ±0.1 | FA             |
|           | 3.2 ±0.3  | 1.6 ±0.2  | 1.25 ±0.2 | FB             |
|           | 3.2 ±0.3  | 1.6 ±0.2  | 1.6 ±0.2  | FC             |
|           | 3.2 ±0.3  | 1.6 ±0.3  | 1.6 ±0.3  | FD             |

**CAPACITANCE RANGE & THICKNESS FOR X7R**

**Table 6** Sizes from I210

| CAP.   | I210  |      |      |      |      |      |      |      |
|--------|-------|------|------|------|------|------|------|------|
|        | 6.3 V | 10 V | 16 V | 25 V | 50 V | 100V | 200V | 250V |
| 2.2 nF | G0    | G0   | G0   | G0   | G0   | G0   | G0   | G0   |
| 3.3 nF | G0    | G0   | G0   | G0   | G0   | G0   | G0   | G0   |
| 4.7 nF | G0    | G0   | G0   | G0   | G0   | G0   | G0   | G0   |
| 6.8 nF | G0    | G0   | G0   | G0   | G0   | G0   | G0   | G0   |
| 10 nF  | G0    | G0   | G0   | G0   | G0   | G0   | G0   | G0   |
| 15 nF  | G0    | G0   | G0   | G0   | G0   | G0   | G0   | G0   |
| 22 nF  | G0    | G0   | G0   | G0   | G0   | G0   | GA   | GA   |
| 33 nF  | G0    | G0   | G0   | G0   | G0   | G0   | GA   | GA   |
| 47 nF  | G0    | G0   | G0   | G0   | G0   | G0   | GA   | GA   |
| 68 nF  | G0    | G0   | G0   | G0   | G0   | G0   | GA   | GA   |
| 100 nF | G0    | G0   | G0   | G0   | G0   | G0   | GA   | GA   |
| 150 nF | G0    | G0   | G0   | G0   | GA   | GA   | GA   | GA   |
| 220 nF | G0    | G0   | G0   | G0   | GA   | GA   | GA   | GA   |
| 330 nF | G0    | G0   | G0   | G0   | GA   | GA   |      |      |
| 470 nF | GA    | GA   | GA   | GA   | GA   | GA   |      |      |
| 680 nF | GA    | GA   | GA   | GA   | GA   | G3   |      |      |
| 1 μF   | GA    | GA   | GA   | GA   | GA   | G3   |      |      |
| 2.2 μF | G3    | G3   | G3   | G3   | G3   | G3   |      |      |
| 4.7 μF | GB    | GB   | GB   | GB   | GD   |      |      |      |
| 10 μF  | GB    | GB   | GB   | GB   | GD   |      |      |      |
| 22 μF  | GC    | GC   | GC   | GC   |      |      |      |      |
| 47 μF  | GC    | GC   |      |      |      |      |      |      |

**NOTE**

1. Values in shaded cells indicate thickness class in mm
2. Capacitance value of non E-6 series is on request
3. For product with 5% tolerance, please contact local sales force before ordering
4. Please contact local sales force for special ordering code before ordering

| CASE SIZE | L (mm)   | W (mm)   | T (mm)    | DIMENSION CODE |
|-----------|----------|----------|-----------|----------------|
| I210      | 3.2 ±0.2 | 2.5 ±0.2 | 0.85 ±0.1 | G0             |
|           | 3.2 ±0.4 | 2.5 ±0.3 | 1.25 ±0.2 | GA             |
|           | 3.2 ±0.4 | 2.5 ±0.3 | 1.6 ±0.2  | G2             |
|           | 3.2 ±0.4 | 2.5 ±0.3 | 1.9 ±0.2  | GB             |
|           | 3.2 ±0.4 | 2.5 ±0.3 | 2.0 ±0.2  | G3             |
|           | 3.2 ±0.4 | 2.5 ±0.3 | 2.5 ±0.2  | GC             |
|           | 3.2 ±0.4 | 2.5 ±0.3 | 2.5 ±0.3  | GD             |



**Table 7** Sizes from 1812 to 2220

| CAP.      | 1812 |      |      |      | 2220 |
|-----------|------|------|------|------|------|
|           | 50 V | 100V | 200V | 250V | 50 V |
| 4.7 nF    | JA   | JA   | JA   | JA   |      |
| 6.8 nF    | JA   | JA   | JA   | JA   |      |
| 10 nF     | JA   | JA   | JA   | JA   |      |
| 15 nF     | JA   | JA   | JA   | JA   |      |
| 22 nF     | JA   | JA   | JA   | JA   |      |
| 33 nF     | JA   | JA   | JA   | JA   |      |
| 47 nF     | JA   | JA   | JB   | JB   |      |
| 68 nF     | JA   | JA   | JB   | JB   |      |
| 100 nF    | JB   | JB   | JB   | JB   |      |
| 150 nF    | JB   | JB   | JB   | JB   |      |
| 220 nF    | JB   | JB   | JC   | JC   |      |
| 330 nF    | JB   | JB   | JC   | JC   |      |
| 470 nF    | JB   | JB   | JC   | JC   | KA   |
| 680 nF    | JC   | JC   |      |      |      |
| 1 $\mu$ F | JC   | JC   |      |      | KA   |

**NOTE**

1. Values in shaded cells indicate thickness class in mm
2. Capacitance value of non E-6 series is on request
3. For product with 5% tolerance, please contact local sales force before ordering
4. Please contact local sales force for special ordering code before ordering

| CASE SIZE | L (mm)        | W (mm)        | T (mm)         | DIMENSION CODE |
|-----------|---------------|---------------|----------------|----------------|
| 1812      | 4.5 $\pm$ 0.2 | 3.2 $\pm$ 0.2 | 0.85 $\pm$ 0.1 | JA             |
|           | 4.5 $\pm$ 0.2 | 3.2 $\pm$ 0.2 | 1.25 $\pm$ 0.2 | JB             |
|           | 4.5 $\pm$ 0.4 | 3.2 $\pm$ 0.4 | 1.6 $\pm$ 0.2  | JC             |
| 2220      | 5.7 $\pm$ 0.4 | 5.0 $\pm$ 0.3 | 1.15 $\pm$ 0.1 | KA             |

**THICKNESS CLASSES AND PACKING QUANTITY**

Table 8

| SIZE CODE | THICKNESS CLASSIFICATION | TAPE WIDTH QUANTITY PER REEL | Ø180 MM / 7 INCH |                | Ø330 MM / 13 INCH |         | QUANTITY PER BULK CASE |
|-----------|--------------------------|------------------------------|------------------|----------------|-------------------|---------|------------------------|
|           |                          |                              | Paper            | Blister        | Paper             | Blister |                        |
| 0201      | 0.3 ±0.03 mm             | 8 mm                         | 15,000           | ---            | 50,000            | ---     | ---                    |
| 0402      | 0.5 ±0.05 mm             | 8 mm                         | 10,000           | ---            | 50,000            | ---     | 50,000                 |
| 0603      | 0.8 ±0.1 mm              | 8 mm                         | 4,000            | ---            | 15,000            | ---     | 15,000                 |
| 0805      | 0.6 ±0.1 mm              | 8 mm                         | 4,000            | ---            | 20,000            | ---     | 10,000                 |
|           | 0.85 ±0.1 mm             | 8 mm                         | 4,000            | ---            | 15,000            | ---     | 8,000                  |
|           | 1.25 ±0.2 mm             | 8 mm                         | ---              | 3,000          | ---               | 10,000  | 5,000                  |
| 1206      | 0.6 ±0.1 mm              | 8 mm                         | 4,000            | ---            | 20,000            | ---     | ---                    |
|           | 0.85 ±0.1 mm             | 8 mm                         | 4,000            | ---            | 15,000            | ---     | ---                    |
|           | 1.00 / 1.15 ±0.1 mm      | 8 mm                         | ---              | 3,000          | ---               | 10,000  | ---                    |
|           | 1.25 ±0.2 mm             | 8 mm                         | ---              | 3,000          | ---               | 10,000  | ---                    |
|           | 1.6 ±0.15 mm             | 8 mm                         | ---              | 2,500          | ---               | 10,000  | ---                    |
|           | 1.6 ±0.2 mm              | 8 mm                         | ---              | 2,000          | ---               | 8,000   | ---                    |
| 1210      | 0.6 / 0.7 ±0.1 mm        | 8 mm                         | ---              | 4,000          | ---               | 15,000  | ---                    |
|           | 0.85 ±0.1 mm             | 8 mm                         | ---              | 4,000          | ---               | 10,000  | ---                    |
|           | 1.15 ±0.1 mm             | 8 mm                         | ---              | 3,000          | ---               | 10,000  | ---                    |
|           | 1.15 ±0.15 mm            | 8 mm                         | ---              | 3,000          | ---               | 10,000  | ---                    |
|           | 1.25 ±0.2 mm             | 8 mm                         | ---              | 3,000          | ---               | ---     | ---                    |
|           | 1.5 ±0.1 mm              | 8 mm                         | ---              | 2,000          | ---               | ---     | ---                    |
|           | 1.6 / 1.9 ±0.2 mm        | 8 mm                         | ---              | 2,000          | ---               | ---     | ---                    |
|           | 2.0 ±0.2 mm              | 8 mm                         | ---              | 2,000<br>1,000 | ---               | ---     | ---                    |
| 1808      | 1.15 ±0.15 mm            | 12 mm                        | ---              | 3,000          | ---               | ---     | ---                    |
|           | 1.25 ±0.2 mm             | 12 mm                        | ---              | 3,000          | ---               | ---     | ---                    |
|           | 1.35 ±0.15 mm            | 12 mm                        | ---              | 2,000          | ---               | ---     | ---                    |
|           | 1.5 ±0.1 mm              | 12 mm                        | ---              | 2,000          | ---               | ---     | ---                    |
|           | 1.6 ±0.2 mm              | 12 mm                        | ---              | 2,000          | ---               | 8,000   | ---                    |
|           | 2.0 ±0.2 mm              | 12 mm                        | ---              | 2,000          | ---               | ---     | ---                    |
| 1812      | 0.6 / 0.85 ±0.1 mm       | 12 mm                        | ---              | 2,000          | ---               | ---     | ---                    |
|           | 1.15 ±0.1 mm             | 12 mm                        | ---              | 1,000          | ---               | ---     | ---                    |
|           | 1.25 ±0.2 mm             | 12 mm                        | ---              | 1,000          | ---               | ---     | ---                    |
|           | 1.5 ±0.1 mm              | 12 mm                        | ---              | 1,000          | ---               | ---     | ---                    |
|           | 1.6 ±0.2 mm              | 12 mm                        | ---              | 1,000          | ---               | ---     | ---                    |
|           | 2.0 ±0.2 mm              | 12 mm                        | ---              | 1,000          | ---               | ---     | ---                    |
| 2220      | 2.5 ±0.2 mm              | 12 mm                        | ---              | 500            | ---               | ---     | ---                    |
|           | 1.15 ± 0.1 mm            | 12 mm                        | ---              | 1,500          | ---               | ---     | ---                    |

**ELECTRICAL CHARACTERISTICS**

**X7R DIELECTRIC CAPACITORS; NISN TERMINATIONS**

Unless otherwise specified, all test and measurements shall be made under standard atmospheric conditions for testing as given in 5.3 of IEC 60068-1:

- Temperature: 15 °C to 35 °C
- Relative humidity: 25% to 75%
- Air pressure: 86 kPa to 106 kPa

Before the measurements are made, the capacitor shall be stored at the measuring temperature for a time sufficient to allow the entire capacitor to reach this temperature.

The period as prescribed for recovery at the end of a test is normally sufficient for this purpose.

Table 9

| DESCRIPTION   |                | VALUE   |                |                |                |                |              |              |        |
|---|----------------|---|----------------|----------------|----------------|----------------|--------------|--------------|--------|
| Capacitance range   |                | 100 pF to 47 μF   |                |                |                |                |              |              |        |
| Capacitance tolerance   |                | ±5%, ±10%, ±20%   |                |                |                |                |              |              |        |
| Dissipation factor (D.F.)   |                |   |                |                |                |                |              |              |        |
| X7R   | 0201           | 0402  | 0603           | 0805           | 1206           | 1210           | 1812         | 2220         | D.F.   |
| ≤6.3V   | 100pF to 10nF  | 100pF to 100nF  | 100pF to 1μF   | 150pF to 2.2μF | 220pF to 2.2μF | 2.2nF to 2.2μF | 6.8nF to 1μF |              | ≤5%    |
|   | 100nF          | 220nF to 470nF, 2.2μF   | 2.2μF to 4.7μF | 4.7μF to 10μF  | 4.7μF to 22μF  | 4.7μF to 47μF  |              |              | ≤10%   |
|   |                | 1μF   |                |                |                |                |              |              | ≤12.5% |
| 10V   | 100pF to 10nF  | 100pF to 100nF  | 100pF to 1μF   | 150pF to 2.2μF | 220pF to 2.2μF | 2.2nF to 2.2μF | 6.8nF to 1μF |              | ≤5%    |
|   | 100nF          | 220nF to 470nF  | 2.2μF to 4.7μF | 4.7μF to 10μF  | 4.7μF to 22μF  | 4.7μF to 47μF  |              |              | ≤10%   |
|   |                | 1μF   |                |                |                |                |              |              | ≤12.5% |
| 16V   | 100pF to 1.2nF | 100pF to 22nF   | 100pF to 220nF | 150pF to 470nF | 220pF to 1μF   | 2.2nF to 1μF   | 6.8nF to 1μF |              | ≤3.5%  |
|   | 1.5nF to 10nF  | 27nF to 100nF   | 270nF to 1μF   | 680nF to 2.2μF | 2.2μF          | 2.2μF          |              |              | ≤5%    |
|   |                | 220nF   | 2.2μF          | 4.7μF to 10μF  | 4.7μF to 22μF  | 4.7μF to 22μF  |              |              | ≤10%   |
| 25V   |                | 100pF to 10nF   | 100pF to 39nF  | 150pF to 180nF | 220pF to 180nF | 2.2nF to 1μF   | 6.8nF to 1μF |              | ≤2.5%  |
|   | 100pF to 470pF | 12nF to 47nF  | 47nF to 220nF  | 220nF to 220nF | 220nF to 1μF   |                |              |              | ≤3.5%  |
|   | 560pF to 10nF  | 56nF to 100nF   | 270nF to 470nF | 560nF to 2.2μF | 2.2μF          | 2.2μF          |              |              | ≤5%    |
| 50V   |                | 120nF to 220nF  | 680nF to 1μF   | 4.7μF          | 4.7μF to 10μF  | 4.7μF to 22μF  |              |              | ≤10%   |
|   |                | 100pF to 10nF   | 100pF to 39nF  | 150pF to 180nF | 220pF to 180nF | 2.2nF to 1μF   | 6.8nF to 1μF | 470nF to 1μF | ≤2.5%  |
|   | 100pF to 470pF | 12nF to 33nF  | 47nF to 220nF  | 220nF to 470nF | 220nF to 1μF   |                |              |              | ≤3.5%  |
| 100V  | 560pF to 1nF   |   |                | 560nF to 680nF |                |                |              |              | ≤5%    |
|   |                | 47nF to 82nF  |                |                |                |                |              |              | ≤7%    |
|   |                | 100nF   | 470nF to 1μF   | 1μF to 2.2μF   | 2.2μF to 4.7μF | 2.2μF to 10μF  |              |              | ≤10%   |
| 200/250V  |                | 100pF to 10nF   | 100pF to 10nF  | 220pF to 470nF | 220pF to 470nF | 2.2nF to 680nF | 6.8nF to 1μF |              | ≤2.5%  |
|   |                |   |                |                | 560nF to 820nF | 1μF to 2.2μF   |              |              | ≤3.5%  |
|   |                |   | 12nF to 100nF  | 560nF to 1μF   | 1μF to 2.2μF   |                |              |              | ≤5%    |
| Insulation resistance after 1 minute at U <sub>r</sub> (DC)                                       |                | R <sub>ins</sub> ≥ 10 GΩ or R <sub>ins</sub> × C <sub>r</sub> ≥ 500/100/50* seconds whichever is less |                |                |                |                |              |              |        |
| Maximum capacitance change as a function of temperature (temperature characteristic/coefficient): |                | ±15%  |                |                |                |                |              |              |        |
| Operating temperature range:  |                | -55 °C to +125 °C   |                |                |                |                |              |              |        |

**NOTE**

| X7R   | 0201          | 0402           | 0603           | 0805           | 1206           | 1210           | 1812           | 2220  | * I.R                                |
|-------|---------------|----------------|----------------|----------------|----------------|----------------|----------------|-------|--------------------------------------|
| ≤6.3V | 100pF to 10nF | 100pF to 220nF | 100pF to 470nF | 220pF to 2.2μF | 220pF to 2.2μF | 2.2nF to 4.7μF | 6.8nF to 1μF   |       | Rins ≥ 10 GΩor<br>Rins × Cr ≥ 500Ω.F |
|       | 100nF         |                | 560nF to 2.2μF | 4.7μF to 10μF  | 4.7μF to 47μF  | 10μF to 47μF   |                |       | Rins × Cr ≥ 100Ω.F                   |
|       |               | 470nF to 1μF   | 4.7μF          |                |                |                |                |       | Rins × Cr ≥ 50Ω.F                    |
| 10V   | 100pF to 10nF | 100pF to 100nF | 100pF to 470nF | 220pF to 2.2μF | 220pF to 2.2μF | 2.2nF to 4.7μF | 6.8nF to 1μF   |       | Rins ≥ 10 GΩor<br>Rins × Cr ≥ 500Ω.F |
|       |               |                | 560nF to 2.2μF | 4.7μF to 10μF  | 4.7μF to 47μF  | 10μF to 47μF   |                |       | Rins × Cr ≥ 100Ω.F                   |
|       |               | 220nF to 1μF   |                |                |                |                |                |       | Rins × Cr ≥ 50Ω.F                    |
| 16V   | 100pF to 10nF | 100pF to 100nF | 100pF to 470nF | 220pF to 2.2μF | 220pF to 2.2μF | 2.2nF to 4.7μF | 6.8nF to 1μF   |       | Rins ≥ 10 GΩor<br>Rins × Cr ≥ 500Ω.F |
|       |               |                | 560nF to 1μF   | 4.7μF to 10μF  | 4.7μF to 22μF  | 10μF to 22μF   |                |       | Rins × Cr ≥ 100Ω.F                   |
|       |               | 220nF          | 2.2μF          |                |                |                |                |       | Rins × Cr ≥ 50Ω.F                    |
| 25V   | 100pF to 10nF | 100pF to 100nF | 100pF to 220nF | 220pF to 1μF   | 220pF to 2.2μF | 2.2nF to 2.2μF | 6.8nF to 1μF   |       | Rins ≥ 10 GΩor<br>Rins × Cr ≥ 500Ω.F |
|       |               |                | 270nF to 1μF   | 2.2μF to 4.7μF | 4.7μF to 10μF  | 4.7μF to 10μF  |                |       | Rins × Cr ≥ 100Ω.F                   |
|       |               | 220nF          |                |                |                |                |                |       | Rins × Cr ≥ 50Ω.F                    |
| 50V   | 100pF to 1nF  | 100pF to 82nF  | 100pF to 220nF | 220pF to 1μF   | 220pF to 100nF | 2.2nF to 1μF   | 6.8nF to 330nF | 470nF | Rins ≥ 10 GΩor<br>Rins × Cr ≥ 500Ω.F |
|       |               | 100nF          | 270nF to 1μF   | 2.2μF          | 120nF to 4.7μF | 2.2μF to 10μF  | 470nF to 1μF   | 1μF   | Rins × Cr ≥ 100Ω.F                   |
|       |               | 100pF to 10nF  | 100pF to 100nF | 220pF to 1μF   | 220pF to 100nF | 2.2nF to 56nF  | 6.8nF to 330nF |       | Rins ≥ 10 GΩor<br>Rins × Cr ≥ 500Ω.F |
| 100V  |               |                |                |                | 120nF to 2.2μF | 68nF to 2.2μF  | 470nF to 1μF   |       | Rins × Cr ≥ 100Ω.F                   |
|       |               |                | 220pF to 22nF  | 220pF to 100nF | 220pF to 22nF  | 2.2nF to 33nF  | 6.8nF to 120nF |       | Rins ≥ 10 GΩor<br>Rins × Cr ≥ 500Ω.F |
|       |               |                |                |                | 27nF to 100nF  | 39nF to 220nF  | 150nF to 470nF |       | Rins × Cr ≥ 100Ω.F                   |

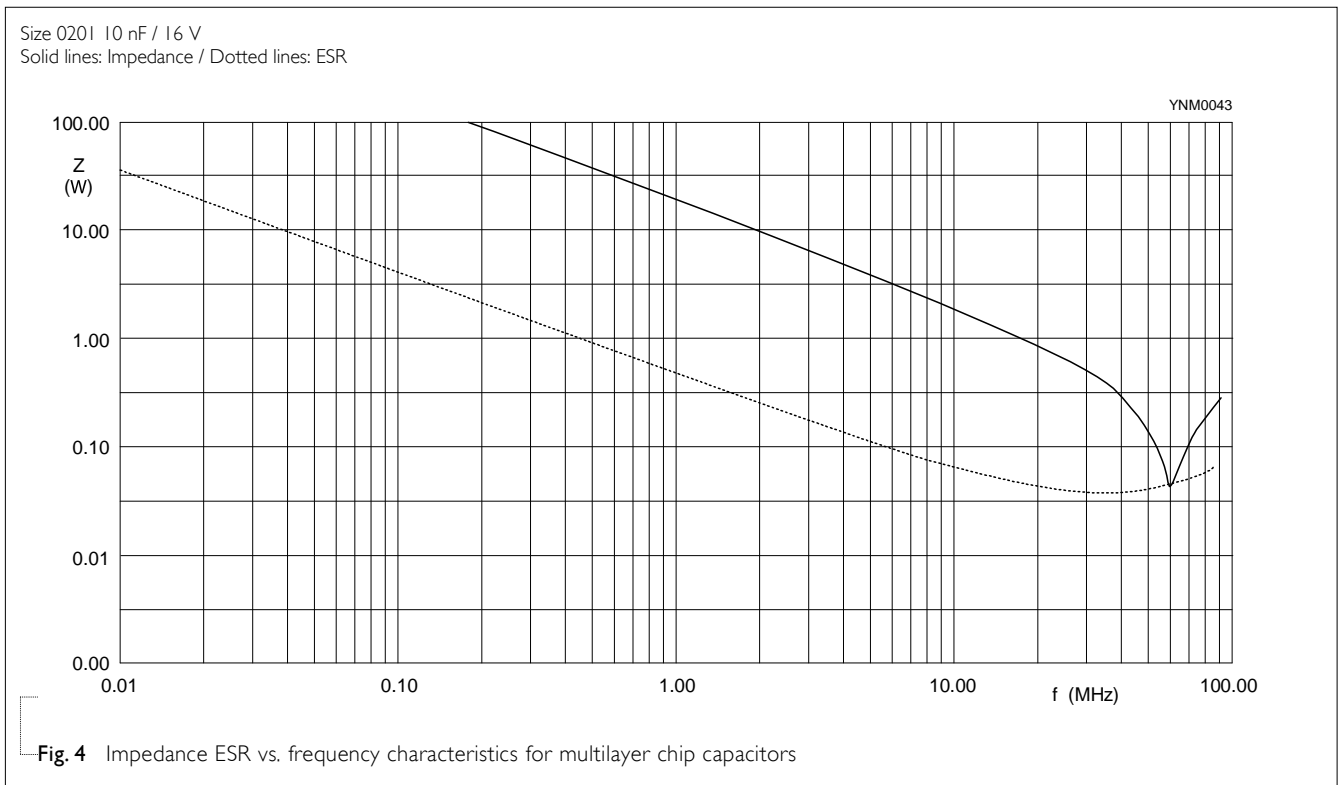
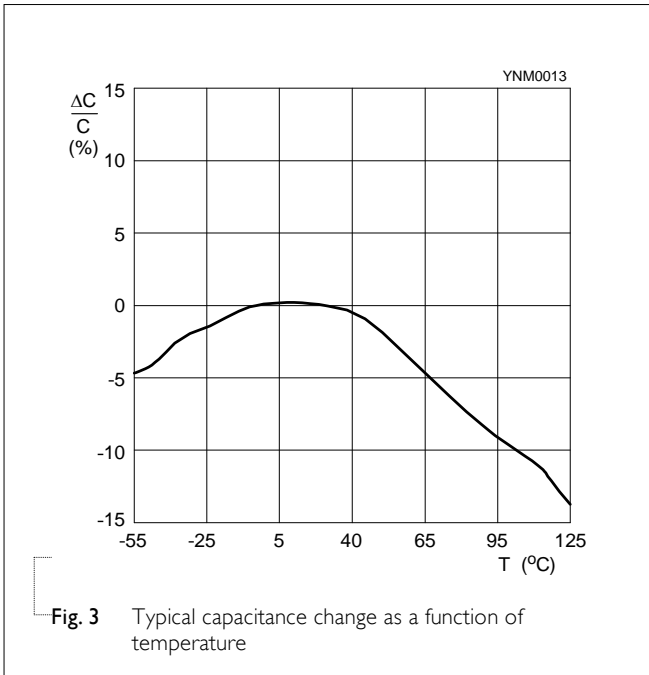

Size 0402 100 nF / 16 V  
Solid lines: Impedance / Dotted lines: ESR

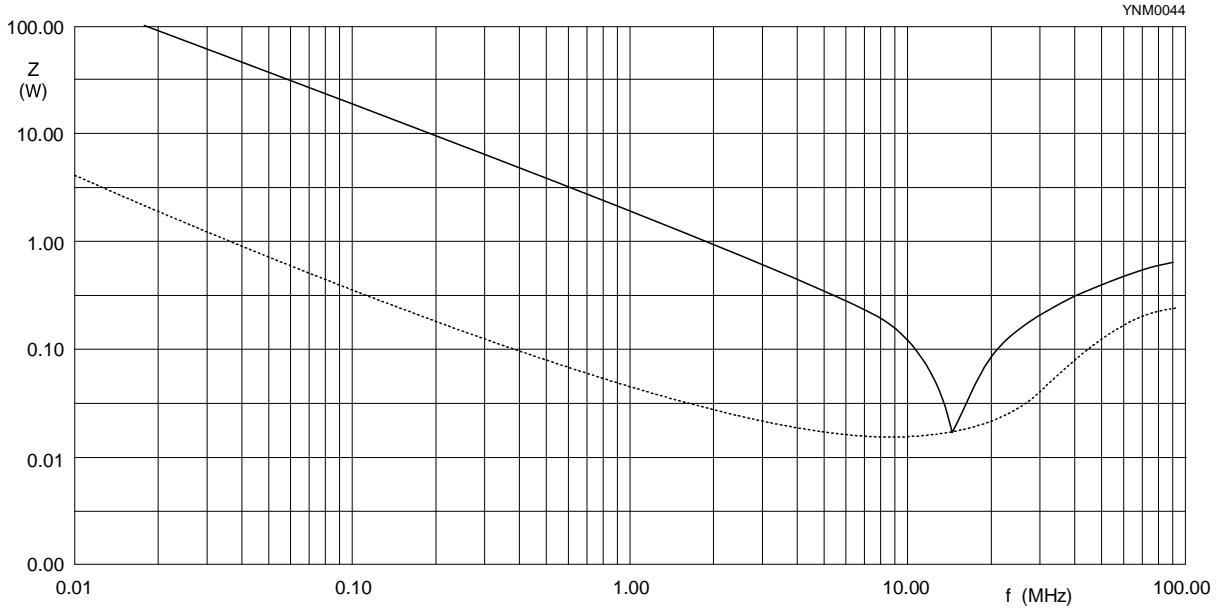

**Fig. 5** Impedance ESR vs. frequency characteristics for multilayer chip capacitors

Size 0603 1  $\mu$ F / 16 V  
Solid lines: Impedance / Dotted lines: ESR

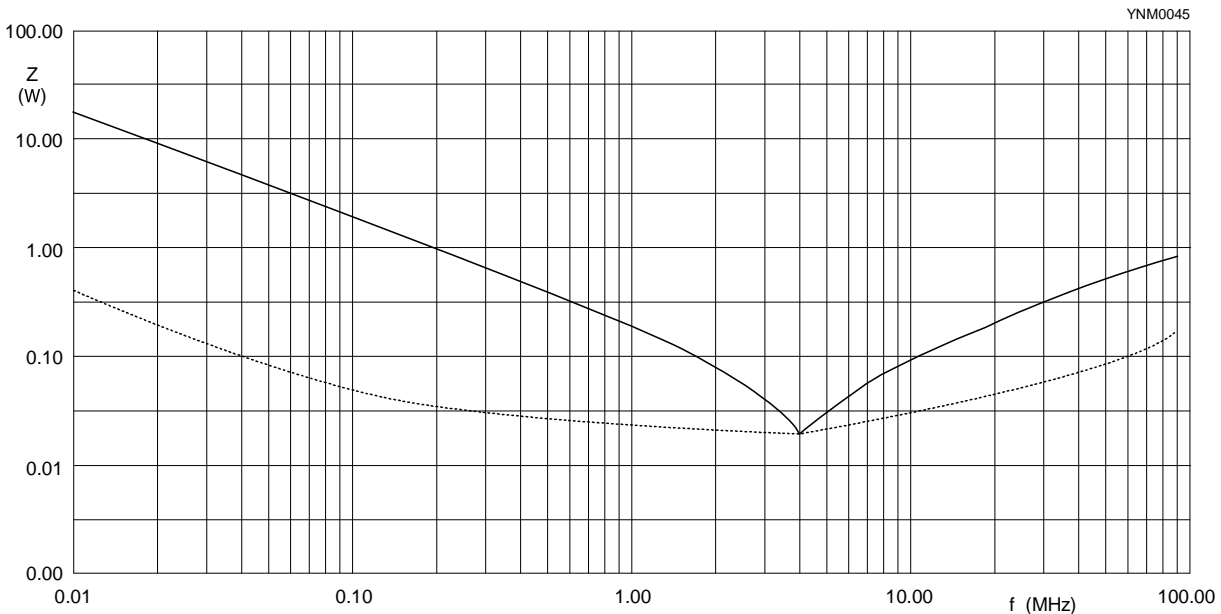

**Fig. 6** Impedance ESR vs. frequency characteristics for multilayer chip capacitors

Size 0805 1  $\mu$ F / 16 V  
Solid lines: Impedance / Dotted lines: ESR

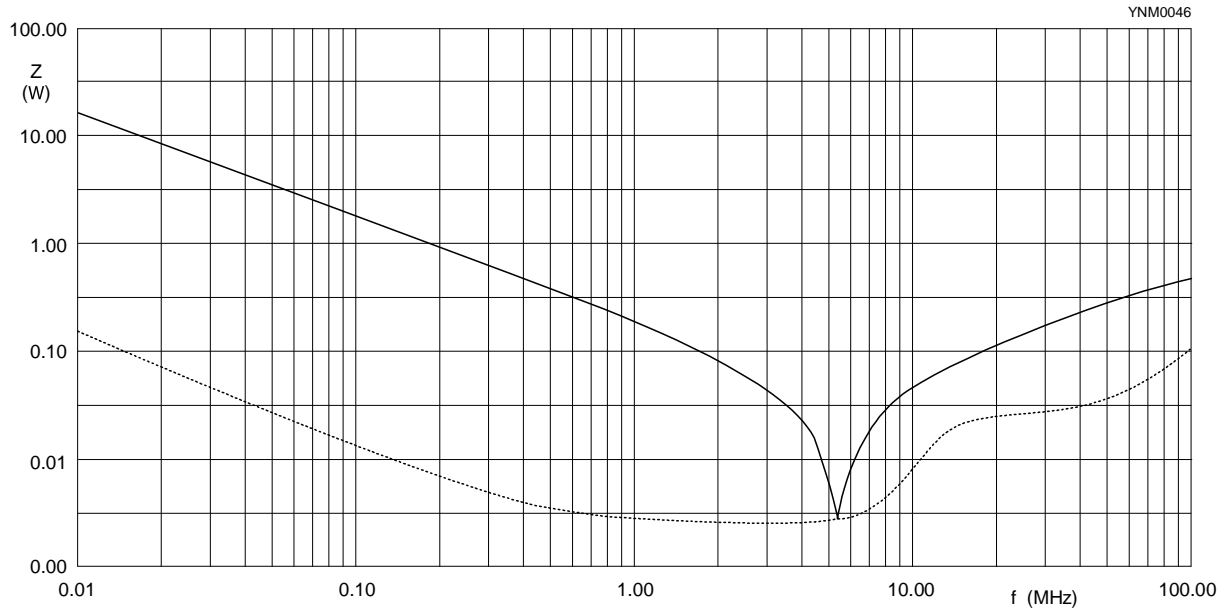

YNM0046

**Fig. 7** Impedance ESR vs. frequency characteristics for multilayer chip capacitors

Size 1206 1  $\mu$ F / 25 V  
Solid lines: Impedance / Dotted lines: ESR

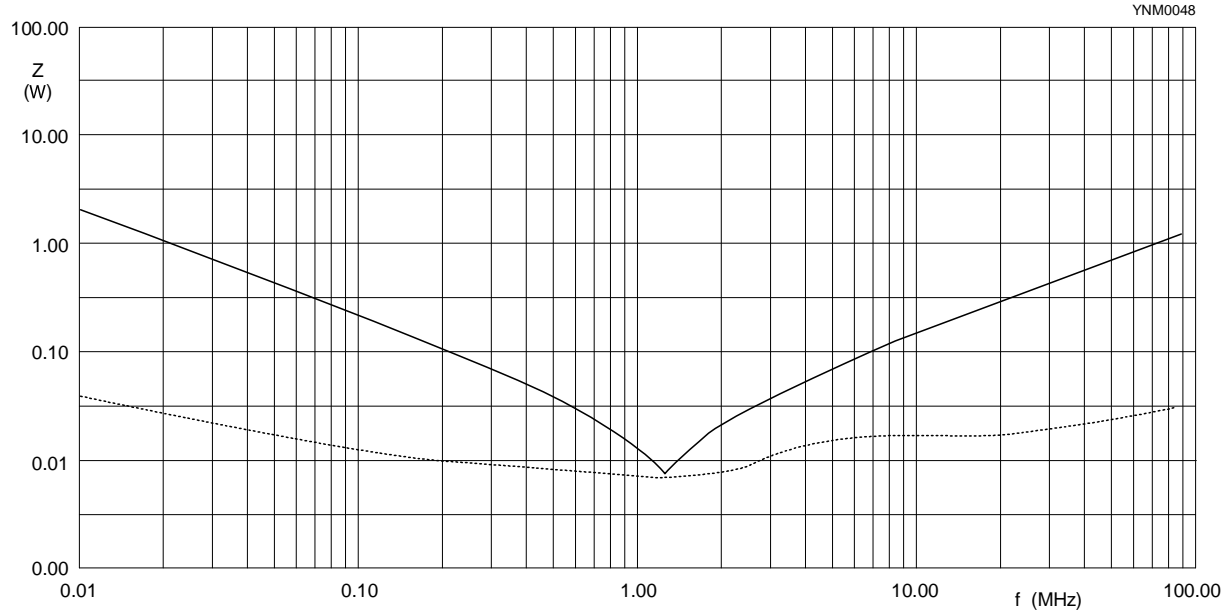

YNM0048

**Fig. 8** Impedance ESR vs. frequency characteristics for multilayer chip capacitors

Size 1206 10  $\mu$ F / 10 V  
Solid lines: Impedance / Dotted lines: ESR

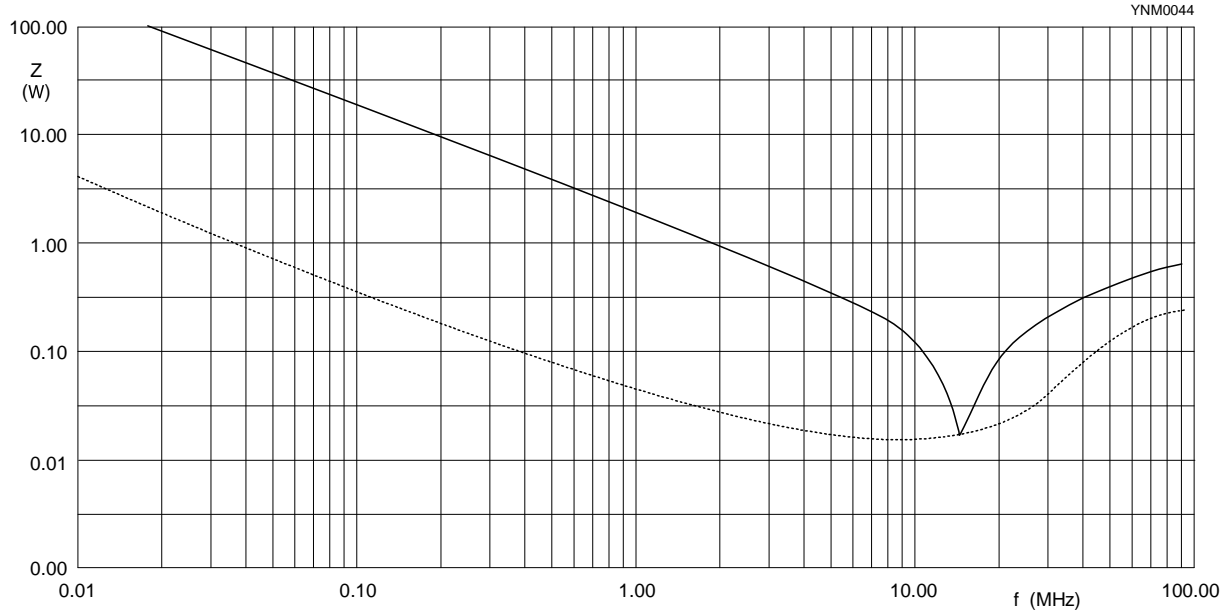

Fig. 9 Impedance ESR vs. frequency characteristics for multilayer chip capacitors



**TESTS AND REQUIREMENTS**

Table 10 Test procedures and requirements

| TEST                                     | TEST METHOD     | PROCEDURE   | REQUIREMENTS                     |
|--|-----------------|---|----------------------------------|
| Mounting                                 | IEC 60384-21/22 | 4.3 The capacitors may be mounted on printed-circuit boards or ceramic substrates   | No visible damage                |
| Visual Inspection and Dimension Check    |                 | 4.4 Any applicable method using × 10 magnification  | In accordance with specification |
| Capacitance <sup>(1)</sup>               |                 | 4.5.1 Class II:   | Within specified tolerance       |
| Dissipation Factor (D.F.) <sup>(1)</sup> |                 | 4.5.2 At 20°C, 24 hrs after annealing<br>Cap ≤ 1 μF, f = 1 KHz, measuring at voltage 1 Vrms at 20°C<br>Cap > 1 μF, f = 1 KHz for C ≤ 10 μF, rated voltage > 6.3 V, measuring at voltage 1 Vrms at 20°C<br>f = 1 KHz, for C ≤ 10 μF, rated voltage ≤ 6.3 V, measuring at voltage 0.5 Vrms at 20°C<br>f = 120 Hz for C > 10 μF, measuring at voltage 0.5 Vrms at 20°C |                                  |
| Insulation Resistance                    |                 | 4.5.3 At U <sub>r</sub> (DC) for 1 minute   | In accordance with specification |

**NOTE:**

I. For individual product specification, please contact local sales.

| TEST                       | TEST METHOD           | PROCEDURE  | REQUIREMENTS   |                 |   |      |   |                       |   |      |   |                       |   |      |                                       |
|----------------------------|-----------------------|--|--|-----------------|---|------|---|-----------------------|---|------|---|-----------------------|---|------|---------------------------------------|
| Temperature Characteristic | IEC 60384- 21/22 4.6  | <p>Capacitance shall be measured by the steps shown in the following table.</p> <p>The capacitance change should be measured after 5 min at each specified temperature stage.</p> <table border="1"> <thead> <tr> <th>Step</th> <th>Temperature(°C)</th> </tr> </thead> <tbody> <tr> <td>a</td> <td>25±2</td> </tr> <tr> <td>b</td> <td>Lower temperature±3°C</td> </tr> <tr> <td>c</td> <td>25±2</td> </tr> <tr> <td>d</td> <td>Upper Temperature±2°C</td> </tr> <tr> <td>e</td> <td>25±2</td> </tr> </tbody> </table> <p>Class II</p> <p>Capacitance Change shall be calculated from the formula as below</p> $\Delta C = \frac{C2 - C1}{C1} \times 100\%$ <p>C1: Capacitance at step c<br/>C2: Capacitance at step b or d</p> | Step   | Temperature(°C) | a | 25±2 | b | Lower temperature±3°C | c | 25±2 | d | Upper Temperature±2°C | e | 25±2 | <p>Class II:<br/>X7R: Δ C/C: ±15%</p> |
| Step                       | Temperature(°C)       |  |  |                 |   |      |   |                       |   |      |   |                       |   |      |                                       |
| a                          | 25±2                  |  |  |                 |   |      |   |                       |   |      |   |                       |   |      |                                       |
| b                          | Lower temperature±3°C |  |  |                 |   |      |   |                       |   |      |   |                       |   |      |                                       |
| c                          | 25±2                  |  |  |                 |   |      |   |                       |   |      |   |                       |   |      |                                       |
| d                          | Upper Temperature±2°C |  |  |                 |   |      |   |                       |   |      |   |                       |   |      |                                       |
| e                          | 25±2                  |  |  |                 |   |      |   |                       |   |      |   |                       |   |      |                                       |
| Adhesion                   | 4.7                   | <p>A force applied for 10 seconds to the line joining the terminations and in a plane parallel to the substrate</p>  | <p>Force<br/>size ≥ 0603: 5N<br/>size = 0402: 2.5N<br/>size = 0201: 1N</p> |                 |   |      |   |                       |   |      |   |                       |   |      |                                       |

| TEST | TEST METHOD | PROCEDURE | REQUIREMENTS |
|------|-------------|-----------|--------------|
|------|-------------|-----------|--------------|

|                  |     |  |                   |
|------------------|-----|--|-------------------|
| Bending Strength | 4.8 | Mounting in accordance with IEC 60384-22 paragraph 4.3 | No visible damage |
|------------------|-----|--|-------------------|

Conditions: bending 1 mm at a rate of 1 mm/s, radius jig 5 mm

Test Substrate:

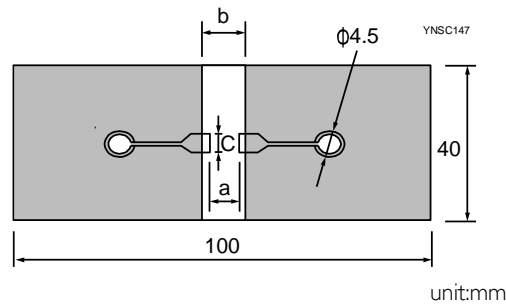

$\Delta C/C$

Class II:

<General purpose series>

X7R:  $\pm 10\%$

<High Capacitance series>

X7R:  $\pm 12.5\%$

| Type | Dimension(mm) |     |      |
|------|---------------|-----|------|
|      | a             | b   | c    |
| 0201 | 0.3           | 0.9 | 0.3  |
| 0402 | 0.4           | 1.5 | 0.5  |
| 0603 | 1.0           | 3.0 | 1.2  |
| 0805 | 1.2           | 4.0 | 1.65 |
| 1206 | 2.2           | 5.0 | 1.65 |
| 1210 | 2.2           | 5.0 | 2.0  |
| 1808 | 3.5           | 7.0 | 3.7  |

|                              |     |  |  |
|------------------------------|-----|--|--|
| Resistance to Soldering Heat | 4.9 | Precondition: 150 $\pm 0/-10^\circ\text{C}$ for 1 hour, then keep for 24 $\pm 1$ hours at room temperature | Dissolution of the end face plating shall not exceed 25% of the length of the edge concerned |
|------------------------------|-----|--|--|

Preheating: for size  $\leq 1206$ : 120 $^\circ\text{C}$  to 150 $^\circ\text{C}$  for 1 minute

Preheating: for size  $> 1206$ : 100 $^\circ\text{C}$  to 120 $^\circ\text{C}$  for 1 minute and 170 $^\circ\text{C}$  to 200 $^\circ\text{C}$  for 1 minute

Solder bath temperature: 260  $\pm 5^\circ\text{C}$

Dipping time: 10  $\pm 0.5$  seconds

Recovery time: 24  $\pm 2$  hours

$\Delta C/C$

Class II:

X7R:  $\pm 10\%$

D.F. within initial specified value

$R_{ins}$  within initial specified value

| TEST                        | TEST METHOD     | PROCEDURE   | REQUIREMENTS   |
|-----------------------------|-----------------|---|--|
| Solderability               | IEC 60384-21/22 | 4.10<br>Preheated to a temperature of 80°C to 140°C and maintained for 30 seconds to 60 seconds.<br><br>1. Temperature: 235±5°C / Dipping time: 2 ±0.5 s<br>2. Temperature: 245±5°C / Dipping time: 3 ±0.5 s (lead free)<br>Depth of immersion: 10mm  | The solder should cover over 95% of the critical area of each termination  |
| Rapid Change of Temperature |                 | 4.11<br>Preconditioning:<br>150 +0/-10°C for 1 hour, then keep for 24 ± 1 hours at room temperature<br><br>5 cycles with following detail:<br>30 minutes at lower category temperature<br>30 minutes at upper category temperature<br><br>Recovery time 24 ± 2 hours  | No visual damage<br><br>$\Delta C/C$<br>Class II:<br>X7R: ±15%<br><br>D.F. meet initial specified value<br>$R_{ins}$ meet initial specified value  |
| Damp Heat with $U_r$ Load   | IEC 60384-21/22 | 4.13<br>1. Preconditioning, Class II only:<br>150 +0/-10°C / 1 hour, then keep for 24 ± 1 hour at room temp<br>2. Initial measure:<br>Spec: refer to initial spec C, D, IR<br>3. Damp heat test:<br>500 ± 12 hours at 40 ± 2°C;<br>90 to 95% R.H. 1.0 $U_r$ applied<br>4. Recovery:<br>Class II: 24 ± 2 hours<br>5. Final measure: C, D, IR<br><br>P.S. If the capacitance value is less than the minimum value permitted, then after the other measurements have been made the capacitor shall be preconditioned according to "IEC 60384 4.1" and then the requirement shall be met.<br><br>* Note | No visual damage after recovery<br><br><General Purpose series><br>$\Delta C/C$<br>Class II:<br>X7R: ±15%<br>D.F.<br>Class II:<br>X7R :<br>$\leq 16V: \leq 7\%$ or 2 x initial value whichever is greater<br>$\geq 25V: \leq 5\%$ or 2 x initial value whichever is greater<br>$R_{ins}$<br>Class II:<br>X7R: $\geq 500 M\Omega$ or $R_{ins} \times C_r \geq 25s$ whichever is less<br><br><High Capacitance series><br>$\Delta C/C$<br>Class II:<br>X7R: ±20%<br>D.F.<br>Class II:<br>X7R: 2 x initial value max<br>$R_{ins}$<br>Class II:<br>X7R: 500 M $\Omega$ or $R_{ins} \times C_r \geq 5s$ whichever is less |

\* Note

| X7R    | 0201          | 0402           | 0603           | 0805           | 1206           | 1210           | 1812           | Product Type     |
|--------|---------------|----------------|----------------|----------------|----------------|----------------|----------------|------------------|
| ≤ 6.3V | 100pF to 10nF | 100pF to 100nF | 100pF to 470nF | 220pF to 1μF   | 220pF to 1μF   | 2.2nF to 1μF   |                | General Purpose  |
|        | 100nF         | 220nF to 2.2μF | 560nF to 4.7μF | 2.2μF to 10μF  | 2.2μF to 22μF  | 2.2μF to 47μF  |                | High Capacitance |
| 10V    | 100pF to 10nF | 100pF to 100nF | 100pF to 470nF | 220pF to 1μF   | 220pF to 1μF   | 2.2nF to 1μF   |                | General Purpose  |
|        |               | 220nF to 1μF   | 560nF to 4.7μF | 2.2μF to 10μF  | 2.2μF to 22μF  | 2.2μF to 47μF  |                | High Capacitance |
| 16V    | 100pF to 10nF | 100pF to 100nF | 100pF to 470nF | 220pF to 1μF   | 220pF to 1μF   | 2.2nF to 1μF   |                | General Purpose  |
|        |               | 220nF          | 560nF to 2.2μF | 2.2μF to 10μF  | 2.2μF to 22μF  | 2.2μF to 22μF  |                | High Capacitance |
| 25V    | 100pF to 10nF | 100pF to 100nF | 100pF to 470nF | 220pF to 1μF   | 220pF to 1μF   | 2.2nF to 1μF   |                | General Purpose  |
|        |               |                | 560nF to 1μF   | 2.2μF to 4.7μF | 2.2μF to 10μF  | 2.2μF to 22μF  |                | High Capacitance |
| 50V    | 100pF to 1nF  | 100pF to 47nF  | 100pF to 220nF | 220pF to 1μF   | 220pF to 1μF   | 2.2nF to 1μF   | 4.7nF to 1μF   | General Purpose  |
|        |               | 100nF          | 560nF to 1μF   | 2.2μF          | 2.2μF to 4.7μF | 2.2μF to 10μF  |                | High Capacitance |
| 100V   |               | 100pF to 10nF  | 100pF to 100nF | 220pF to 1μF   | 220pF to 1μF   | 2.2nF to 1μF   | 4.7nF to 470nF | General Purpose  |
|        |               |                |                |                | 2.2μF          | 2.2μF          |                | High Capacitance |
| 250V   |               |                | 220pF to 22nF  | 220pF to 100nF | 220pF to 100nF | 2.2nF to 220nF | 4.7nF to 470nF | General Purpose  |

| TEST      | TEST METHOD          | PROCEDURE  | REQUIREMENTS   |
|-----------|----------------------|--|--|
| Endurance | IEC 60384-21/22 4.14 | <ol style="list-style-type: none"> <li>Preconditioning, class 2 only:<br/>150 +0/-10 °C /1 hour, then keep for<br/>24 ± 1 hour at room temp</li> <li>Initial measure:<br/>Spec: refer to initial spec C, D, IR</li> <li>Endurance test:<br/>Temperature: X7R: 125 °C<br/>Specified stress voltage applied for 1,000 hours:<br/>Applied 2.0 × U<sub>r</sub> for general products*<br/>Applied 1.5 × U<sub>r</sub> for high cap. Products*</li> <li>Recovery time: 24 ± 2 hours</li> <li>Final measure: C, D, IR</li> </ol> <p>P.S. If the capacitance value is less than the minimum value permitted, then after the other measurements have been made the capacitor shall be preconditioned according to "IEC 60384 4.1" and then the requirement shall be met.</p> <p><b>* Note</b></p> | <p>No visual damage</p> <hr/> <p>&lt;General Purpose series&gt;<br/> <math>\Delta C/C</math><br/>                     Class II:<br/>                     X7R: ± 15%<br/>                     D.F.<br/>                     Class II:<br/>                     X7R :<br/> <math>\leq 16V: \leq 7\%</math> or 2 × initial value whichever is greater<br/> <math>\geq 25V: \leq 5\%</math> or 2 × initial value whichever is greater</p> <p>R<sub>ins</sub><br/>                     Class II:<br/>                     X7R: <math>\geq 1,000 M\Omega</math> or R<sub>ins</sub> × C<sub>r</sub> <math>\geq 50s</math> whichever is less</p> <hr/> <p>&lt;High Capacitance series&gt;<br/> <math>\Delta C/C</math><br/>                     Class II:<br/>                     X7R: ± 20%<br/>                     D.F.<br/>                     Class II:<br/>                     X7R: 2 × initial value max<br/>                     R<sub>ins</sub><br/>                     Class II:<br/>                     X7R: <math>1,000 M\Omega</math> or R<sub>ins</sub> × C<sub>r</sub> <math>\geq 10s</math> whichever is less</p> |

**\* Note**

| X7R   | 0201          | 0402           | 0603           | 0805           | 1206           | 1210           | 1812           | 2220         | Test voltage         |
|-------|---------------|----------------|----------------|----------------|----------------|----------------|----------------|--------------|----------------------|
| ≤6.3V | 100pF to 10nF | 100pF to 100nF | 100pF to 470nF | 220pF to 1μF   | 220pF to 1μF   | 2.2nF to 1μF   |                |              | 200% × Rated voltage |
|       | 100nF         | 220nF to 2.2μF | 560nF to 4.7μF | 2.2μF to 10μF  | 2.2μF to 22μF  | 2.2μF to 47μF  |                |              | 150% × Rated voltage |
| 10V   | 100pF to 10nF | 100pF to 100nF | 100pF to 470nF | 220pF to 1μF   | 220pF to 1μF   | 2.2nF to 1μF   |                |              | 200% × Rated voltage |
|       |               | 220nF to 1μF   | 560nF to 4.7μF | 2.2μF to 10μF  | 2.2μF to 22μF  | 2.2μF to 47μF  |                |              | 150% × Rated voltage |
| 16V   | 100pF to 10nF | 100pF to 100nF | 100pF to 470nF | 220pF to 1μF   | 220pF to 1μF   | 2.2nF to 1μF   |                |              | 200% × Rated voltage |
|       |               | 220nF          | 560nF to 2.2μF | 2.2μF to 10μF  | 2.2μF to 22μF  | 2.2μF to 22μF  |                |              | 150% × Rated voltage |
| 25V   | 100pF to 10nF | 100pF to 100nF | 100pF to 470nF | 220pF to 1μF   | 220pF to 1μF   | 2.2nF to 1μF   |                |              | 200% × Rated voltage |
|       |               |                | 560nF to 1μF   | 2.2μF to 4.7μF | 2.2μF to 10μF  | 2.2μF to 22μF  |                |              | 150% × Rated voltage |
| 50V   | 100pF to 1nF  | 100pF to 47nF  | 100pF to 330nF | 220pF to 1μF   | 220pF to 1μF   | 2.2nF to 1μF   | 4.7nF to 1μF   | 470nF to 1μF | 200% × Rated voltage |
|       |               | 100nF          | 470nF to 1μF   | 2.2μF          | 2.2μF to 4.7μF | 2.2μF to 10μF  |                |              | 150% × Rated voltage |
| 100V  |               | 100pF to 10nF  | 100pF to 100nF | 220pF to 680nF | 220pF to 1μF   | 2.2nF to 1μF   | 4.7nF to 1μF   |              | 200% × Rated voltage |
|       |               |                |                | 1μF            | 2.2μF          | 2.2μF          |                |              | 150% × Rated voltage |
| 250V  |               |                | 220pF to 22nF  | 220pF to 100nF | 220pF to 100nF | 2.2nF to 220nF | 4.7nF to 470nF |              | 150% × Rated voltage |

|                      |             |     |   |  |
|----------------------|-------------|-----|---|--|
| <b>Voltage Proof</b> | IEC 60384-1 | 4.6 | 1. Specified stress voltage applied for 1~5 seconds<br>2. $U_r \leq 100$ V: series applied $2.5 U_r$<br>3. $100$ V < $U_r \leq 200$ V series applied ( $1.5 U_r + 100$ )<br>4. $200$ V < $U_r \leq 500$ V series applied ( $1.3 U_r + 100$ )<br>Charge/Discharge current is less than 50 mA | No breakdown or flashover  |
| <b>Vibration</b>     | AEC-Q200    | 14  | 5 g's for 20 minutes, 12 cycles each of 3 orientations.<br>Note:<br>Use 8" x 5" PCB. 0.31" thick 7 secure points on one long side and 2 secure points at corners of opposite sides. Parts mounted within 2" from any secure point. Test from 10-2000 Hz.                                    | $\Delta C/C$<br>NP0: Within $\pm 0.5\%$ or 0.5 pF, whichever is greater<br>X7R: $\pm 10\%$<br><hr/> D.F: meet initial specified value<br>IR meet initial specified value |

**REVISION HISTORY**

| REVISION   | DATE            | CHANGE NOTIFICATION | DESCRIPTION   |
|------------|-----------------|---------------------|---|
| Version 22 | Oct. 07, 2022   | -                   | - I206/4.7uF/6.3V to 16V I.R. updated   |
| Version 21 | Sep. 06, 2022   | -                   | - Dissipation factor and I.R. spec updated  |
| Version 20 | Sep. 8, 2020    | -                   | - 0402, 220nF to 470nF, 10V Insulation resistance after 1 minute at Ur (DC) updated   |
| Version 19 | Aug. 17, 2020   | -                   | - Add 0402/220nF/25V  |
| Version 18 | May. 11th, 2017 | -                   | - Add 1210/10uF/50V   |
| Version 17 | Mar. 7th, 2017  | -                   | - 0805 L4 spec updated<br>- Dimension updated   |
| Version 16 | Dec. 7th, 2016  | -                   | - Dimension updated   |
| Version 15 | Oct. 3rd, 2016  | -                   | - Dimension updated, Soldering recommendation updated   |
| Version 14 | May 31st, 2016  | -                   | - Dimension updated   |
| Version 13 | Dec. 30, 2015   | -                   | - Dimension on 0603 and 1206 case size updated  |
| Version 12 | May 26, 2015    | -                   | - 1210, 25V dissipation factor updated  |
| Version 11 | Jan. 06, 2015   | -                   | - 0402, 100nF, 50V Dissipation factor (D.F.) updated.   |
| Version 10 | Jul. 08, 2014   | -                   | - Dimension updated   |
| Version 9  | Aug. 19, 2013   | -                   | - Dimension updated   |
| Version 8  | Oct. 13, 2011   | -                   | - Dimension updated<br>- 50V Dissipation factor(D.F) updated  |
| Version 7  | Jan. 13, 2011   | -                   | - Dimension updated   |
| Version 6  | Oct. 13, 2010   | -                   | - Rated voltage of 0201 extend to 50 V<br>- Capacitance range of 0201 X7R 6.3V to 16V extend to 100 pF<br>- Capacitance range of 0805 X7R 10V extend to 10 μF<br>- Capacitance range of 0805 X7R 50V extend to 1 μF<br>- Capacitance range of 1210 X7R 10V extend to 22 μF<br>- Figures of impedance ESR updated  |
| Version 5  | Jul 27, 2010    | -                   | - Dimension on 0603 and 1206 case size updated<br>- 16V to 25V Dissipation factor(D.F) updated  |
| Version 4  | Apr 21, 2010    | -                   | - The statement of "Halogen Free" on the cover added<br>- Dimension updated   |
| Version 3  | Oct 26, 2009    | -                   | - Capacitance range of 0402 X7R 25 V extend to 100 nF<br>- 16V Dissipation factor updated   |
| Version 2  | May 11, 2009    | -                   | - Product range updated   |
| Version 1  | Apr 24, 2009    | -                   | - Ordering code updated   |
| Version 0  | Apr 15, 2009    | -                   | - New datasheet for general purpose and high capacitance X7R series with RoHS compliant<br>- Replace the "6.3V to 50V" part of pdf files: X7R_10V_9, X7R_16V-to-100V_9, X7R_16-to-500V_9, UP-X5R_X7R_HighCaps_6.3-to-25V_11, UY-X5R_X7R_HighCaps_6.3-to-25V_11<br>- Combine 0201 from pdf files: UP-NPOX5RX7RY5V_0201_6.3-to-50V_2 and UY-NPOX5RX7RY5V_0201_6.3-to-50V_2<br>- Define global part number<br>- Description of "Halogen Free compliant" added<br>- Test method and procedure updated |