

## Two-Line ESD Protection in SOT-23

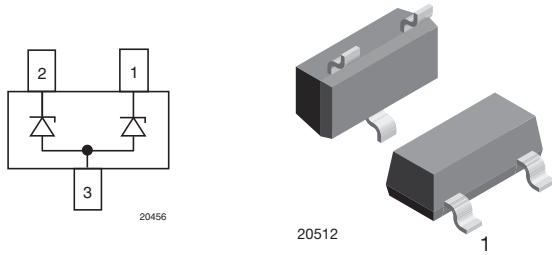

### MARKING (example only)

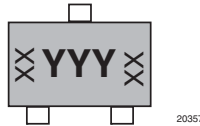

YYY = type code (see table below)  
XX = date code

### FEATURES

- Two-line ESD protection device
- ESD immunity acc. IEC 61000-4-2  
± 30 kV contact discharge  
± 30 kV air discharge
- ESD capability according to AEC-Q101:  
human body model: class H3B: > 8 kV
- Space saving SOT-23 package
- e3 - Sn
- AEC-Q101 qualified available
- Material categorization: for definitions of compliance please see [www.vishay.com/doc?99912](http://www.vishay.com/doc?99912)



### DESIGN SUPPORT TOOLS AVAILABLE



ORDERING INFORMATION							
PART NUMBER (EXAMPLE)	ENVIRONMENTAL AND QUALITY CODE				PACKAGING CODE		ORDERING CODE (EXAMPLE)
	AEC-Q101 QUALIFIED	RoHS-COMPLIANT + LEAD (Pb)-FREE		TIN PLATED	3K PER 7" REEL (8 mm TAPE), 15K/BOX = MOQ	10K PER 13" REEL (8 mm TAPE), 10K/BOX = MOQ	
		STANDARD	GREEN				
GSOT05C-		E		3	-08		GSOT05C-E3-08
GSOT05C-			G	3	-08		GSOT05C-G3-08
GSOT05C-	H	E		3	-08		GSOT05C-HE3-08
GSOT05C-	H		G	3	-08		GSOT05C-HG3-08
GSOT05C-		E		3		-18	GSOT05C-E3-18
GSOT05C-			G	3		-18	GSOT05C-G3-18
GSOT05C-	H	E		3		-18	GSOT05C-HE3-18
GSOT05C-	H		G	3		-18	GSOT05C-HG3-18

PACKAGE DATA							
DEVICE NAME	PACKAGE NAME	TYPE CODE	ENVIRONMENTAL STATUS	WEIGHT	MOLDING COMPOUND FLAMMABILITY RATING	MOISTURE SENSITIVITY LEVEL	SOLDERING CONDITIONS
GSOT03C	SOT-23	03C	Standard	8.8 mg	UL 94 V-0	MSL level 1 (according J-STD-020)	Peak temperature max. 260 °C
		C1G	Green	8.1 mg			
GSOT04C	SOT-23	04C	Standard	8.8 mg	UL 94 V-0	MSL level 1 (according J-STD-020)	Peak temperature max. 260 °C
		C8G	Green	8.1 mg			
GSOT05C	SOT-23	05C	Standard	8.8 mg	UL 94 V-0	MSL level 1 (according J-STD-020)	Peak temperature max. 260 °C
		C2G	Green	8.1 mg			
GSOT08C	SOT-23	08C	Standard	8.8 mg	UL 94 V-0	MSL level 1 (according J-STD-020)	Peak temperature max. 260 °C
		C3G	Green	8.1 mg			
GSOT12C	SOT-23	12C	Standard	8.8 mg	UL 94 V-0	MSL level 1 (according J-STD-020)	Peak temperature max. 260 °C
		C4G	Green	8.1 mg			
GSOT15C	SOT-23	15C	Standard	8.8 mg	UL 94 V-0	MSL level 1 (according J-STD-020)	Peak temperature max. 260 °C
		C5G	Green	8.1 mg			
GSOT24C	SOT-23	24C	Standard	8.8 mg	UL 94 V-0	MSL level 1 (according J-STD-020)	Peak temperature max. 260 °C
		C6G	Green	8.1 mg			
GSOT36C	SOT-23	36C	Standard	8.8 mg	UL 94 V-0	MSL level 1 (according J-STD-020)	Peak temperature max. 260 °C
		C7G	Green	8.1 mg			



<b>ABSOLUTE MAXIMUM RATINGS GSOT03C</b>				
PARAMETER	TEST CONDITIONS	SYMBOL	VALUE	UNIT
Peak pulse current	Pin 1 to 3 or pin 2 to 3 acc. IEC 61000-4-5, $t_p = 8/20 \mu\text{s}$ ; single shot	$I_{PPM}$	30	A
	Pin 1 to 2 or pin 2 to 1; pin 3 not connected acc. IEC 61000-4-5, $t_p = 8/20 \mu\text{s}$ ; single shot		30	A
Peak pulse power	Pin 1 to 3 or pin 2 to 3 acc. IEC 61000-4-5, $t_p = 8/20 \mu\text{s}$ ; single shot	$P_{PP}$	369	W
	Pin 1 to 2 or pin 2 to 1; pin 3 not connected acc. IEC 61000-4-5, $t_p = 8/20 \mu\text{s}$ ; single shot		504	W
ESD immunity	Contact discharge acc. IEC 61000-4-2; 10 pulses	$V_{ESD}$	$\pm 30$	kV
	Air discharge acc. IEC 61000-4-2; 10 pulses		$\pm 30$	kV
Operating temperature	Junction temperature	$T_J$	-55 to +150	$^{\circ}\text{C}$
Storage temperature		$T_{STG}$	-55 to +150	$^{\circ}\text{C}$

<b>ABSOLUTE MAXIMUM RATINGS GSOT04C</b>				
PARAMETER	TEST CONDITIONS	SYMBOL	VALUE	UNIT
Peak pulse current	Pin 1 to 3 or pin 2 to 3 acc. IEC 61000-4-5, $t_p = 8/20 \mu\text{s}$ ; single shot	$I_{PPM}$	30	A
	Pin 1 to 2 or pin 2 to 1; pin 3 not connected acc. IEC 61000-4-5, $t_p = 8/20 \mu\text{s}$ ; single shot		30	A
Peak pulse power	Pin 1 to 3 or pin 2 to 3 acc. IEC 61000-4-5, $t_p = 8/20 \mu\text{s}$ ; single shot	$P_{PP}$	429	W
	Pin 1 to 2 or pin 2 to 1; pin 3 not connected acc. IEC 61000-4-5, $t_p = 8/20 \mu\text{s}$ ; single shot		564	W
ESD immunity	Contact discharge acc. IEC 61000-4-2; 10 pulses	$V_{ESD}$	$\pm 30$	kV
	Air discharge acc. IEC 61000-4-2; 10 pulses		$\pm 30$	kV
Operating temperature	Junction temperature	$T_J$	-55 to +150	$^{\circ}\text{C}$
Storage temperature		$T_{STG}$	-55 to +150	$^{\circ}\text{C}$

<b>ABSOLUTE MAXIMUM RATINGS GSOT05C</b>				
PARAMETER	TEST CONDITIONS	SYMBOL	VALUE	UNIT
Peak pulse current	Pin 1 to 3 or pin 2 to 3 acc. IEC 61000-4-5, $t_p = 8/20 \mu\text{s}$ ; single shot	$I_{PPM}$	30	A
	Pin 1 to 2 or pin 2 to 1; pin 3 not connected acc. IEC 61000-4-5, $t_p = 8/20 \mu\text{s}$ ; single shot		30	A
Peak pulse power	Pin 1 to 3 or pin 2 to 3 acc. IEC 61000-4-5, $t_p = 8/20 \mu\text{s}$ ; single shot	$P_{PP}$	480	W
	Pin 1 to 2 or pin 2 to 1; pin 3 not connected acc. IEC 61000-4-5, $t_p = 8/20 \mu\text{s}$ ; single shot		612	W
ESD immunity	Contact discharge acc. IEC 61000-4-2; 10 pulses	$V_{ESD}$	$\pm 30$	kV
	Air discharge acc. IEC 61000-4-2; 10 pulses		$\pm 30$	kV
Operating temperature	Junction temperature	$T_J$	-55 to +150	$^{\circ}\text{C}$
Storage temperature		$T_{STG}$	-55 to +150	$^{\circ}\text{C}$



<b>ABSOLUTE MAXIMUM RATINGS GSOT08C</b>				
PARAMETER	TEST CONDITIONS	SYMBOL	VALUE	UNIT
Peak pulse current	Pin 1 to 3 or pin 2 to 3 acc. IEC 61000-4-5, $t_p = 8/20 \mu\text{s}$ ; single shot	$I_{PPM}$	18	A
	Pin 1 to 2 or pin 2 to 1; pin 3 not connected acc. IEC 61000-4-5, $t_p = 8/20 \mu\text{s}$ ; single shot		18	A
Peak pulse power	Pin 1 to 3 or pin 2 to 3 acc. IEC 61000-4-5, $t_p = 8/20 \mu\text{s}$ ; single shot	$P_{PP}$	345	W
	Pin 1 to 2 or pin 2 to 1; pin 3 not connected acc. IEC 61000-4-5, $t_p = 8/20 \mu\text{s}$ ; single shot		400	W
ESD immunity	Contact discharge acc. IEC 61000-4-2; 10 pulses	$V_{ESD}$	$\pm 30$	kV
	Air discharge acc. IEC 61000-4-2; 10 pulses		$\pm 30$	kV
Operating temperature	Junction temperature	$T_J$	-55 to +150	$^{\circ}\text{C}$
Storage temperature		$T_{STG}$	-55 to +150	$^{\circ}\text{C}$

<b>ABSOLUTE MAXIMUM RATINGS GSOT12C</b>				
PARAMETER	TEST CONDITIONS	SYMBOL	VALUE	UNIT
Peak pulse current	Pin 1 to 3 or pin 2 to 3 acc. IEC 61000-4-5, $t_p = 8/20 \mu\text{s}$ ; single shot	$I_{PPM}$	12	A
	Pin 1 to 2 or pin 2 to 1; pin 3 not connected acc. IEC 61000-4-5, $t_p = 8/20 \mu\text{s}$ ; single shot		12	A
Peak pulse power	Pin 1 to 3 or pin 2 to 3 acc. IEC 61000-4-5, $t_p = 8/20 \mu\text{s}$ ; single shot	$P_{PP}$	312	W
	Pin 1 to 2 or pin 2 to 1; pin 3 not connected acc. IEC 61000-4-5, $t_p = 8/20 \mu\text{s}$ ; single shot		337	W
ESD immunity	Contact discharge acc. IEC 61000-4-2; 10 pulses	$V_{ESD}$	$\pm 30$	kV
	Air discharge acc. IEC 61000-4-2; 10 pulses		$\pm 30$	kV
Operating temperature	Junction temperature	$T_J$	-55 to +150	$^{\circ}\text{C}$
Storage temperature		$T_{STG}$	-55 to +150	$^{\circ}\text{C}$

<b>ABSOLUTE MAXIMUM RATINGS GSOT15C</b>				
PARAMETER	TEST CONDITIONS	SYMBOL	VALUE	UNIT
Peak pulse current	Pin 1 to 3 or pin 2 to 3 acc. IEC 61000-4-5, $t_p = 8/20 \mu\text{s}$ ; single shot	$I_{PPM}$	8	A
	Pin 1 to 2 or pin 2 to 1; pin 3 not connected acc. IEC 61000-4-5, $t_p = 8/20 \mu\text{s}$ ; single shot		8	A
Peak pulse power	Pin 1 to 3 or pin 2 to 3 acc. IEC 61000-4-5, $t_p = 8/20 \mu\text{s}$ ; single shot	$P_{PP}$	345	W
	Pin 1 to 2 or pin 2 to 1; pin 3 not connected acc. IEC 61000-4-5, $t_p = 8/20 \mu\text{s}$ ; single shot		400	W
ESD immunity	Contact discharge acc. IEC 61000-4-2; 10 pulses	$V_{ESD}$	$\pm 30$	kV
	Air discharge acc. IEC 61000-4-2; 10 pulses		$\pm 30$	kV
Operating temperature	Junction temperature	$T_J$	-55 to +150	$^{\circ}\text{C}$
Storage temperature		$T_{STG}$	-55 to +150	$^{\circ}\text{C}$



ABSOLUTE MAXIMUM RATINGS GSOT24C				
PARAMETER	TEST CONDITIONS	SYMBOL	VALUE	UNIT
Peak pulse current	Pin 1 to 3 or pin 2 to 3 acc. IEC 61000-4-5, $t_p = 8/20 \mu s$ ; single shot	$I_{PPM}$	5	A
	Pin 1 to 2 or pin 2 to 1; pin 3 not connected acc. IEC 61000-4-5, $t_p = 8/20 \mu s$ ; single shot		5	A
Peak pulse power	Pin 1 to 3 or pin 2 to 3 acc. IEC 61000-4-5, $t_p = 8/20 \mu s$ ; single shot	$P_{PP}$	235	W
	Pin 1 to 2 or pin 2 to 1; pin 3 not connected acc. IEC 61000-4-5, $t_p = 8/20 \mu s$ ; single shot		240	W
ESD immunity	Contact discharge acc. IEC 61000-4-2; 10 pulses	$V_{ESD}$	$\pm 30$	kV
	Air discharge acc. IEC 61000-4-2; 10 pulses		$\pm 30$	kV
Operating temperature	Junction temperature	$T_J$	-55 to +150	$^{\circ}C$
Storage temperature		$T_{STG}$	-55 to +150	$^{\circ}C$

ABSOLUTE MAXIMUM RATINGS GSOT36C				
PARAMETER	TEST CONDITIONS	SYMBOL	VALUE	UNIT
Peak pulse current	Pin 1 to 3 or pin 2 to 3 acc. IEC 61000-4-5, $t_p = 8/20 \mu s$ ; single shot	$I_{PPM}$	3.5	A
	Pin 1 to 2 or pin 2 to 1; pin 3 not connected acc. IEC 61000-4-5, $t_p = 8/20 \mu s$ ; single shot		3.5	A
Peak pulse power	Pin 1 to 3 or pin 2 to 3 acc. IEC 61000-4-5, $t_p = 8/20 \mu s$ ; single shot	$P_{PP}$	248	W
	Pin 1 to 2 or pin 2 to 1; pin 3 not connected acc. IEC 61000-4-5, $t_p = 8/20 \mu s$ ; single shot		252	W
ESD immunity	Contact discharge acc. IEC 61000-4-2; 10 pulses	$V_{ESD}$	$\pm 30$	kV
	Air discharge acc. IEC 61000-4-2; 10 pulses		$\pm 30$	kV
Operating temperature	Junction temperature	$T_J$	-55 to +150	$^{\circ}C$
Storage temperature		$T_{STG}$	-55 to +150	$^{\circ}C$

### BiAs-MODE (2-line Bidirectional Asymmetrical protection mode)

With the GSOTxxC two signal- or data-lines (L1, L2) can be protected against voltage transients. With pin 3 connected to ground and pin 1 and pin 2 connected to a signal- or data-line which has to be protected. As long as the voltage level on the data- or signal-line is between 0 V (ground level) and the specified Maximum Reverse Working Voltage ( $V_{RWM}$ ) the protection diode between pin 2 and pin 3 and between pin 1 and pin 3 offers a high isolation to the ground line. The protection device behaves like an open switch.

As soon as any positive transient voltage signal exceeds the breakdown voltage level of the protection diode, the diode becomes conductive and shorts the transient current to ground. Now the protection device behaves like a closed switch. The Clamping Voltage ( $V_C$ ) is defined by the breakdown voltage ( $V_{BR}$ ) level plus the voltage drop at the series impedance (resistance and inductance) of the protection diode.

Any negative transient signal will be clamped accordingly. The negative transient current is flowing in the forward direction through the protection diode. The low Forward Voltage ( $V_F$ ) clamps the negative transient close to the ground level.

Due to the different clamping levels in forward and reverse direction the GSOTxxC clamping behavior is Bidirectional and Asymmetrical (BiAs).



20358

If a higher surge current or peak pulse current ( $I_{PP}$ ) is needed, both protection diodes in the GSOTxxC can also be used in parallel in order to “double” the performance.

This offers:

- double surge power = double peak pulse current ( $2 \times I_{PPM}$ )
- half of the line inductance = reduced clamping voltage
- half of the line resistance = reduced clamping voltage
- double line capacitance ( $2 \times C_D$ )
- double reverse leakage current ( $2 \times I_R$ )

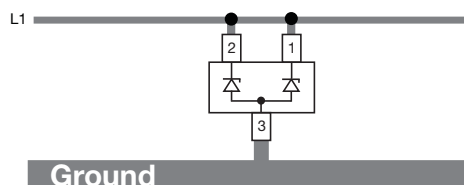

20359

ELECTRICAL CHARACTERISTICS GSOT03C ( $T_{amb} = 25^\circ\text{C}$ unless otherwise specified)						
between pin 1 to pin 3 or pin 2 to pin 3						
PARAMETER	TEST CONDITIONS/REMARKS	SYMBOL	MIN.	TYP.	MAX.	UNIT
Protection paths	Number of lines which can be protected	$N_{channel}$	-	-	2	lines
Reverse stand-off voltage	Max. reverse working voltage	$V_{RWM}$	-	-	3.3	V
Reverse voltage	at $I_R = 100 \mu\text{A}$	$V_R$	3.3	-	-	V
Reverse current	at $V_R = 3.3 \text{ V}$	$I_R$	-	-	100	$\mu\text{A}$
Reverse breakdown voltage	at $I_R = 1 \text{ mA}$	$V_{BR}$	4.0	4.6	5.5	V
Reverse clamping voltage	at $I_{PP} = 1 \text{ A}$	$V_C$	-	5.7	7.5	V
	at $I_{PP} = I_{PPM} = 30 \text{ A}$		-	10	12.3	V
Forward clamping voltage	at $I_{PP} = 1 \text{ A}$	$V_F$	-	1	1.2	V
	at $I_{PP} = I_{PPM} = 30 \text{ A}$		-	4.5	-	V
Capacitance	at $V_R = 0 \text{ V}; f = 1 \text{ MHz}$	$C_D$	-	420	600	pF
	at $V_R = 1.6 \text{ V}; f = 1 \text{ MHz}$		-	260	-	pF



<b>ELECTRICAL CHARACTERISTICS GSOT04C</b> ( $T_{amb} = 25\text{ }^{\circ}\text{C}$ unless otherwise specified) between pin 1 to pin 3 or pin 2 to pin 3						
PARAMETER	TEST CONDITIONS/REMARKS	SYMBOL	MIN.	TYP.	MAX.	UNIT
Protection paths	Number of lines which can be protected	$N_{channel}$	-	-	2	lines
Reverse stand-off voltage	Max. reverse working voltage	$V_{RWM}$	-	-	4	V
Reverse voltage	at $I_R = 20\text{ }\mu\text{A}$	$V_R$	4	-	-	V
Reverse current	at $V_R = 4\text{ V}$	$I_R$	-	-	20	$\mu\text{A}$
Reverse breakdown voltage	at $I_R = 1\text{ mA}$	$V_{BR}$	5	6.1	7	V
Reverse clamping voltage	at $I_{PP} = 1\text{ A}$	$V_C$	-	7.5	9	V
	at $I_{PP} = I_{PPM} = 30\text{ A}$		-	11.2	14.3	V
Forward clamping voltage	at $I_{PP} = 1\text{ A}$	$V_F$	-	1	1.2	V
	at $I_{PP} = I_{PPM} = 30\text{ A}$		-	4.5	-	V
Capacitance	at $V_R = 0\text{ V}$ ; $f = 1\text{ MHz}$	$C_D$	-	310	450	pF
	at $V_R = 2\text{ V}$ ; $f = 1\text{ MHz}$		-	200	-	pF

<b>ELECTRICAL CHARACTERISTICS GSOT05C</b> ( $T_{amb} = 25\text{ }^{\circ}\text{C}$ unless otherwise specified) between pin 1 to pin 3 or pin 2 to pin 3						
PARAMETER	TEST CONDITIONS/REMARKS	SYMBOL	MIN.	TYP.	MAX.	UNIT
Protection paths	Number of lines which can be protected	$N_{channel}$	-	-	2	lines
Reverse stand-off voltage	Max. reverse working voltage	$V_{RWM}$	-	-	5	V
Reverse voltage	at $I_R = 10\text{ }\mu\text{A}$	$V_R$	5	-	-	V
Reverse current	at $V_R = 5\text{ V}$	$I_R$	-	-	10	$\mu\text{A}$
Reverse breakdown voltage	at $I_R = 1\text{ mA}$	$V_{BR}$	6	6.8	8	V
Reverse clamping voltage	at $I_{PP} = 1\text{ A}$	$V_C$	-	7	8.7	V
	at $I_{PP} = I_{PPM} = 30\text{ A}$		-	12	16	V
Forward clamping voltage	at $I_{PP} = 1\text{ A}$	$V_F$	-	1	1.2	V
	at $I_{PP} = I_{PPM} = 30\text{ A}$		-	4.5	-	V
Capacitance	at $V_R = 0\text{ V}$ ; $f = 1\text{ MHz}$	$C_D$	-	260	350	pF
	at $V_R = 2.5\text{ V}$ ; $f = 1\text{ MHz}$		-	150	-	pF

<b>ELECTRICAL CHARACTERISTICS GSOT08C</b> ( $T_{amb} = 25\text{ }^{\circ}\text{C}$ unless otherwise specified) between pin 1 to pin 3 or pin 2 to pin 3						
PARAMETER	TEST CONDITIONS/REMARKS	SYMBOL	MIN.	TYP.	MAX.	UNIT
Protection paths	Number of lines which can be protected	$N_{channel}$	-	-	2	lines
Reverse stand-off voltage	Max. reverse working voltage	$V_{RWM}$	-	-	8	V
Reverse voltage	at $I_R = 5\text{ }\mu\text{A}$	$V_R$	8	-	-	V
Reverse current	at $V_R = 8\text{ V}$	$I_R$	-	-	5	$\mu\text{A}$
Reverse breakdown voltage	at $I_R = 1\text{ mA}$	$V_{BR}$	9	10	11	V
Reverse clamping voltage	at $I_{PP} = 1\text{ A}$	$V_C$	-	10.7	13	V
	at $I_{PP} = I_{PPM} = 18\text{ A}$		-	15.2	19.2	V
Forward clamping voltage	at $I_{PP} = 1\text{ A}$	$V_F$	-	1	1.2	V
	at $I_{PP} = I_{PPM} = 18\text{ A}$		-	3	-	V
Capacitance	at $V_R = 0\text{ V}$ ; $f = 1\text{ MHz}$	$C_D$	-	160	250	pF
	at $V_R = 4\text{ V}$ ; $f = 1\text{ MHz}$		-	80	-	pF



<b>ELECTRICAL CHARACTERISTICS GSOT12C</b> ( $T_{amb} = 25\text{ }^{\circ}\text{C}$ unless otherwise specified) between pin 1 to pin 3 or pin 2 to pin 3						
PARAMETER	TEST CONDITIONS/REMARKS	SYMBOL	MIN.	TYP.	MAX.	UNIT
Protection paths	Number of lines which can be protected	$N_{channel}$	-	-	2	lines
Reverse stand-off voltage	Max. reverse working voltage	$V_{RWM}$	-	-	12	V
Reverse voltage	at $I_R = 1\text{ }\mu\text{A}$	$V_R$	12	-	-	V
Reverse current	at $V_R = 12\text{ V}$	$I_R$	-	-	1	$\mu\text{A}$
Reverse breakdown voltage	at $I_R = 1\text{ mA}$	$V_{BR}$	13.5	15	16.5	V
Reverse clamping voltage	at $I_{PP} = 1\text{ A}$	$V_C$	-	15.4	18.7	V
	at $I_{PP} = I_{PPM} = 12\text{ A}$		-	21.2	26	V
Forward clamping voltage	at $I_{PP} = 1\text{ A}$	$V_F$	-	1	1.2	V
	at $I_{PP} = I_{PPM} = 12\text{ A}$		-	2.2	-	V
Capacitance	at $V_R = 0\text{ V}$ ; $f = 1\text{ MHz}$	$C_D$	-	115	150	pF
	at $V_R = 6\text{ V}$ ; $f = 1\text{ MHz}$		-	50	-	pF

<b>ELECTRICAL CHARACTERISTICS GSOT15C</b> ( $T_{amb} = 25\text{ }^{\circ}\text{C}$ unless otherwise specified) between pin 1 to pin 3 or pin 2 to pin 3						
PARAMETER	TEST CONDITIONS/REMARKS	SYMBOL	MIN.	TYP.	MAX.	UNIT
Protection paths	Number of lines which can be protected	$N_{channel}$	-	-	2	lines
Reverse stand-off voltage	Max. reverse working voltage	$V_{RWM}$	-	-	15	V
Reverse voltage	at $I_R = 1\text{ }\mu\text{A}$	$V_R$	15	-	-	V
Reverse current	at $V_R = 15\text{ V}$	$I_R$	-	-	1	$\mu\text{A}$
Reverse breakdown voltage	at $I_R = 1\text{ mA}$	$V_{BR}$	16.5	18	20	V
Reverse clamping voltage	at $I_{PP} = 1\text{ A}$	$V_C$	-	19.4	23.5	V
	at $I_{PP} = I_{PPM} = 8\text{ A}$		-	24.8	28.8	V
Forward clamping voltage	at $I_{PP} = 1\text{ A}$	$V_F$	-	1	1.2	V
	at $I_{PP} = I_{PPM} = 8\text{ A}$		-	1.8	-	V
Capacitance	at $V_R = 0\text{ V}$ ; $f = 1\text{ MHz}$	$C_D$	-	90	120	pF
	at $V_R = 7.5\text{ V}$ ; $f = 1\text{ MHz}$		-	35	-	pF

<b>ELECTRICAL CHARACTERISTICS GSOT24C</b> ( $T_{amb} = 25\text{ }^{\circ}\text{C}$ unless otherwise specified) between pin 1 to pin 3 or pin 2 to pin 3						
PARAMETER	TEST CONDITIONS/REMARKS	SYMBOL	MIN.	TYP.	MAX.	UNIT
Protection paths	Number of lines which can be protected	$N_{channel}$	-	-	2	lines
Reverse stand-off voltage	Max. reverse working voltage	$V_{RWM}$	-	-	24	V
Reverse voltage	at $I_R = 1\text{ }\mu\text{A}$	$V_R$	24	-	-	V
Reverse current	at $V_R = 24\text{ V}$	$I_R$	-	-	1	$\mu\text{A}$
Reverse breakdown voltage	at $I_R = 1\text{ mA}$	$V_{BR}$	27	30	33	V
Reverse clamping voltage	at $I_{PP} = 1\text{ A}$	$V_C$	-	34	41	V
	at $I_{PP} = I_{PPM} = 5\text{ A}$		-	41	47	V
Forward clamping voltage	at $I_{PP} = 1\text{ A}$	$V_F$	-	1	1.2	V
	at $I_{PP} = I_{PPM} = 5\text{ A}$		-	1.4	-	V
Capacitance	at $V_R = 0\text{ V}$ ; $f = 1\text{ MHz}$	$C_D$	-	65	80	pF
	at $V_R = 12\text{ V}$ ; $f = 1\text{ MHz}$		-	20	-	pF

<b>ELECTRICAL CHARACTERISTICS GSOT36C</b> ( $T_{amb} = 25\text{ }^{\circ}\text{C}$ unless otherwise specified) between pin 1 to pin 3 or pin 2 to pin 3						
PARAMETER	TEST CONDITIONS/REMARKS	SYMBOL	MIN.	TYP.	MAX.	UNIT
Protection paths	Number of lines which can be protected	$N_{channel}$	-	-	2	lines
Reverse stand-off voltage	Max. reverse working voltage	$V_{RWM}$	-	-	36	V
Reverse voltage	at $I_R = 1\text{ }\mu\text{A}$	$V_R$	36	-	-	V
Reverse current	at $V_R = 36\text{ V}$	$I_R$	-	-	1	$\mu\text{A}$
Reverse breakdown voltage	at $I_R = 1\text{ mA}$	$V_{BR}$	39	43	47	V
Reverse clamping voltage	at $I_{PP} = 1\text{ A}$	$V_C$	-	49	60	V
	at $I_{PP} = I_{PPM} = 3.5\text{ A}$		-	59	71	V
Forward clamping voltage	at $I_{PP} = 1\text{ A}$	$V_F$	-	1	1.2	V
	at $I_{PP} = I_{PPM} = 3.5\text{ A}$		-	1.3	-	V
Capacitance	at $V_R = 0\text{ V}$ ; $f = 1\text{ MHz}$	$C_D$	-	52	65	pF
	at $V_R = 18\text{ V}$ ; $f = 1\text{ MHz}$		-	12	-	pF

**BiSy-MODE** (1-line bidirectional symmetrical protection mode)

If a bipolar symmetrical protection device is needed the GSOTxxC can also be used as a single line protection device. Therefore pin 1 has to be connected to the signal- or data-line (L1) and pin 2 to ground (or vice versa). Pin 3 must not be connected. Positive and negative voltage transients will be clamped in the same way. The clamping current through the GSOTxxC passes one diode in forward direction and the other one in reverse direction. The clamping voltage ( $V_C$ ) is defined by the breakthrough voltage ( $V_{BR}$ ) level of one diode plus the forward voltage of the other diode plus the voltage drop at the series impedances (resistances and inductances) of the protection device.

Due to the same clamping levels in positive and negative direction the GSOTxxC voltage clamping behaviour is bidirectional and symmetrical (BiSy).

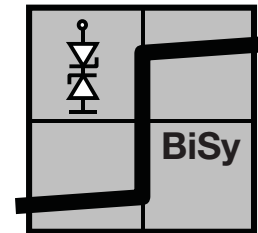
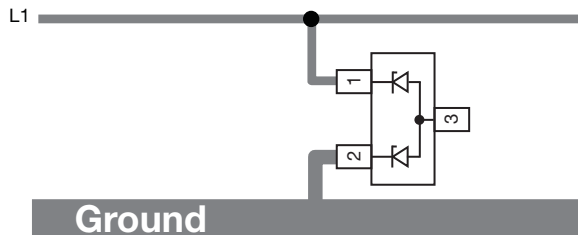

20361

<b>ELECTRICAL CHARACTERISTICS GSOT03C</b> ( $T_{amb} = 25\text{ }^{\circ}\text{C}$ unless otherwise specified) between pin 1 to pin 2 or pin 2 to pin1; pin 3 not connected						
PARAMETER	TEST CONDITIONS/REMARKS	SYMBOL	MIN.	TYP.	MAX.	UNIT
Protection paths	Number of lines which can be protected	$N_{channel}$	-	-	1	lines
Reverse stand-off voltage	Max. reverse working voltage	$V_{RWM}$	-	-	3.8	V
Reverse voltage	at $I_R = 100\text{ }\mu\text{A}$	$V_R$	3.8	-	-	V
Reverse current	at $V_R = 3.8\text{ V}$	$I_R$	-	-	100	$\mu\text{A}$
Reverse breakdown voltage	at $I_R = 1\text{ mA}$	$V_{BR}$	4.5	5.3	6.2	V
Reverse clamping voltage	at $I_{PP} = 1\text{ A}$	$V_C$	-	7	8.4	V
	at $I_{PP} = I_{PPM} = 30\text{ A}$		-	14	16.8	V
Capacitance	at $V_R = 0\text{ V}$ ; $f = 1\text{ MHz}$	$C_D$	-	210	300	pF
	at $V_R = 1.6\text{ V}$ ; $f = 1\text{ MHz}$		-	190	-	pF





<b>ELECTRICAL CHARACTERISTICS GSOT04C</b> ( $T_{amb} = 25\text{ }^{\circ}\text{C}$ unless otherwise specified) between pin 1 to pin 2 or pin 2 to pin1; pin 3 not connected						
PARAMETER	TEST CONDITIONS/REMARKS	SYMBOL	MIN.	TYP.	MAX.	UNIT
Protection paths	Number of lines which can be protected	$N_{channel}$	-	-	1	lines
Reverse stand-off voltage	Max. reverse working voltage	$V_{RWM}$	-	-	4.5	V
Reverse voltage	at $I_R = 20\text{ }\mu\text{A}$	$V_R$	4.5	-	-	V
Reverse current	at $V_R = 4.5\text{ V}$	$I_R$	-	-	20	$\mu\text{A}$
Reverse breakdown voltage	at $I_R = 1\text{ mA}$	$V_{BR}$	5.5	6.8	7.7	V
Reverse clamping voltage	at $I_{PP} = 1\text{ A}$	$V_C$	-	7.5	9	V
	at $I_{PP} = I_{PPM} = 30\text{ A}$		-	15.7	18.8	V
Capacitance	at $V_R = 0\text{ V}$ ; $f = 1\text{ MHz}$	$C_D$	-	155	225	pF
	at $V_R = 2\text{ V}$ ; $f = 1\text{ MHz}$		-	135	-	pF

<b>ELECTRICAL CHARACTERISTICS GSOT05C</b> ( $T_{amb} = 25\text{ }^{\circ}\text{C}$ unless otherwise specified) between pin 1 to pin 2 or pin 2 to pin1; pin 3 not connected						
PARAMETER	TEST CONDITIONS/REMARKS	SYMBOL	MIN.	TYP.	MAX.	UNIT
Protection paths	Number of lines which can be protected	$N_{channel}$	-	-	1	lines
Reverse stand-off voltage	Max. reverse working voltage	$V_{RWM}$	-	-	5.5	V
Reverse voltage	at $I_R = 10\text{ }\mu\text{A}$	$V_R$	5.5	-	-	V
Reverse current	at $V_R = 5.5\text{ V}$	$I_R$	-	-	10	$\mu\text{A}$
Reverse breakdown voltage	at $I_R = 1\text{ mA}$	$V_{BR}$	6.5	7.5	8.7	V
Reverse clamping voltage	at $I_{PP} = 1\text{ A}$	$V_C$	-	8.1	9.7	V
	at $I_{PP} = I_{PPM} = 30\text{ A}$		-	17	20.4	V
Capacitance	at $V_R = 0\text{ V}$ ; $f = 1\text{ MHz}$	$C_D$	-	130	175	pF
	at $V_R = 4\text{ V}$ ; $f = 1\text{ MHz}$		-	100	-	pF

<b>ELECTRICAL CHARACTERISTICS GSOT08C</b> ( $T_{amb} = 25\text{ }^{\circ}\text{C}$ unless otherwise specified) between pin 1 to pin 2 or pin 2 to pin1; pin 3 not connected						
PARAMETER	TEST CONDITIONS/REMARKS	SYMBOL	MIN.	TYP.	MAX.	UNIT
Protection paths	Number of lines which can be protected	$N_{channel}$	-	-	1	lines
Reverse stand-off voltage	Max. reverse working voltage	$V_{RWM}$	-	-	8.5	V
Reverse voltage	at $I_R = 5\text{ }\mu\text{A}$	$V_R$	8.5	-	-	V
Reverse current	at $V_R = 8.5\text{ V}$	$I_R$	-	-	5	$\mu\text{A}$
Reverse breakdown voltage	at $I_R = 1\text{ mA}$	$V_{BR}$	9.5	10.7	11.7	V
Reverse clamping voltage	at $I_{PP} = 1\text{ A}$	$V_C$	-	11.7	14	V
	at $I_{PP} = I_{PPM} = 18\text{ A}$		-	18.5	22.2	V
Capacitance	at $V_R = 0\text{ V}$ ; $f = 1\text{ MHz}$	$C_D$	-	80	125	pF
	at $V_R = 4\text{ V}$ ; $f = 1\text{ MHz}$		-	60	-	pF

<b>ELECTRICAL CHARACTERISTICS GSOT12C</b> ( $T_{amb} = 25\text{ }^{\circ}\text{C}$ unless otherwise specified) between pin 1 to pin 2 or pin 2 to pin1; pin 3 not connected						
PARAMETER	TEST CONDITIONS/REMARKS	SYMBOL	MIN.	TYP.	MAX.	UNIT
Protection paths	Number of lines which can be protected	$N_{channel}$	-	-	1	lines
Reverse stand-off voltage	Max. reverse working voltage	$V_{RWM}$	-	-	12.5	V
Reverse voltage	at $I_R = 1\text{ }\mu\text{A}$	$V_R$	12.5	-	-	V
Reverse current	at $V_R = 12.5\text{ V}$	$I_R$	-	-	1	$\mu\text{A}$
Reverse breakdown voltage	at $I_R = 1\text{ mA}$	$V_{BR}$	13.5	15.7	16.5	V
Reverse clamping voltage	at $I_{PP} = 1\text{ A}$	$V_C$	-	16.4	19.7	V
	at $I_{PP} = I_{PPM} = 12\text{ A}$		-	23.4	28.1	V
Capacitance	at $V_R = 0\text{ V}$ ; $f = 1\text{ MHz}$	$C_D$	-	58	75	pF
	at $V_R = 7.5\text{ V}$ ; $f = 1\text{ MHz}$		-	36	-	pF



<b>ELECTRICAL CHARACTERISTICS GSOT15C</b> ( $T_{amb} = 25\text{ }^{\circ}\text{C}$ unless otherwise specified) between pin 1 to pin 2 or pin 2 to pin1; pin 3 not connected						
PARAMETER	TEST CONDITIONS/REMARKS	SYMBOL	MIN.	TYP.	MAX.	UNIT
Protection paths	Number of lines which can be protected	$N_{channel}$	-	-	1	lines
Reverse stand-off voltage	Max. reverse working voltage	$V_{RWM}$	-	-	15.5	V
Reverse voltage	at $I_R = 1\text{ }\mu\text{A}$	$V_R$	15.5	-	-	V
Reverse current	at $V_R = 15.5\text{ V}$	$I_R$	-	-	1	$\mu\text{A}$
Reverse breakdown voltage	at $I_R = 1\text{ mA}$	$V_{BR}$	17	18.7	20.7	V
Reverse clamping voltage	at $I_{PP} = 1\text{ A}$	$V_C$	-	20.4	24.5	V
	at $I_{PP} = I_{PPM} = 8\text{ A}$		-	26.6	30.6	V
Capacitance	at $V_R = 0\text{ V}$ ; $f = 1\text{ MHz}$	$C_D$	-	45	60	pF
	at $V_R = 7.5\text{ V}$ ; $f = 1\text{ MHz}$		-	25	-	pF

<b>ELECTRICAL CHARACTERISTICS GSOT24C</b> ( $T_{amb} = 25\text{ }^{\circ}\text{C}$ unless otherwise specified) between pin 1 to pin 2 or pin 2 to pin1; pin 3 not connected						
PARAMETER	TEST CONDITIONS/REMARKS	SYMBOL	MIN.	TYP.	MAX.	UNIT
Protection paths	Number of lines which can be protected	$N_{channel}$	-	-	1	lines
Reverse stand-off voltage	Max. reverse working voltage	$V_{RWM}$	-	-	24.5	V
Reverse voltage	at $I_R = 1\text{ }\mu\text{A}$	$V_R$	24.5	-	-	V
Reverse current	at $V_R = 24.5\text{ V}$	$I_R$	-	-	1	$\mu\text{A}$
Reverse breakdown voltage	at $I_R = 1\text{ mA}$	$V_{BR}$	27.5	30.7	33.7	V
Reverse clamping voltage	at $I_{PP} = 1\text{ A}$	$V_C$	-	34	41	V
	at $I_{PP} = I_{PPM} = 5\text{ A}$		-	40	48	V
Capacitance	at $V_R = 0\text{ V}$ ; $f = 1\text{ MHz}$	$C_D$	-	33	40	pF
	at $V_R = 12\text{ V}$ ; $f = 1\text{ MHz}$		-	18	-	pF

<b>ELECTRICAL CHARACTERISTICS GSOT36C</b> ( $T_{amb} = 25\text{ }^{\circ}\text{C}$ unless otherwise specified) between pin 1 to pin 2 or pin 2 to pin1; pin 3 not connected						
PARAMETER	TEST CONDITIONS/REMARKS	SYMBOL	MIN.	TYP.	MAX.	UNIT
Protection paths	Number of lines which can be protected	$N_{channel}$	-	-	1	lines
Reverse stand-off voltage	Max. reverse working voltage	$V_{RWM}$	-	-	36.5	V
Reverse voltage	at $I_R = 1\text{ }\mu\text{A}$	$V_R$	36.5	-	-	V
Reverse current	at $V_R = 36.5\text{ V}$	$I_R$	-	-	1	$\mu\text{A}$
Reverse breakdown voltage	at $I_R = 1\text{ mA}$	$V_{BR}$	39.5	43.7	47.7	V
Reverse clamping voltage	at $I_{PP} = 1\text{ A}$	$V_C$	-	50	60	V
	at $I_{PP} = I_{PPM} = 3.5\text{ A}$		-	60	72	V
Capacitance	at $V_R = 0\text{ V}$ ; $f = 1\text{ MHz}$	$C_D$	-	26	33	pF
	at $V_R = 18\text{ V}$ ; $f = 1\text{ MHz}$		-	10	-	pF

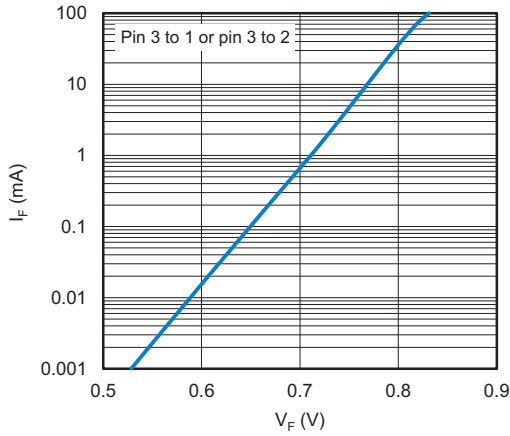

Fig. 1 - Typical Forward Current  $I_F$  vs. Forward Voltage  $V_F$

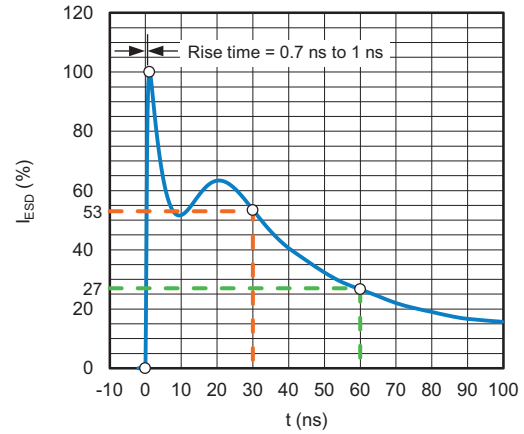

Fig. 4 - ESD Discharge Current Waveform According to IEC 61000-4-2 (330  $\Omega$  / 150 pF)

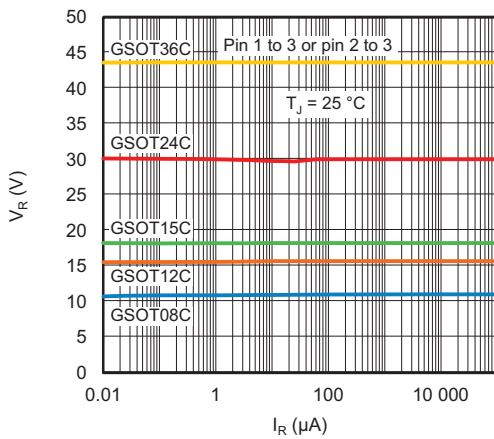

Fig. 2 - Typical Reverse Voltage  $V_R$  vs. Reverse Current  $I_R$

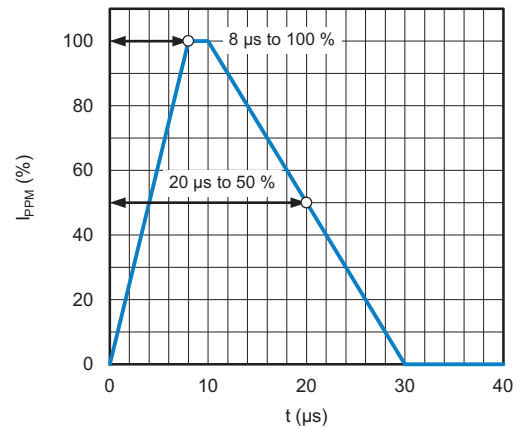

Fig. 5 - 8/20  $\mu$ s Peak Pulse Current Waveform According to IEC 61000-4-5

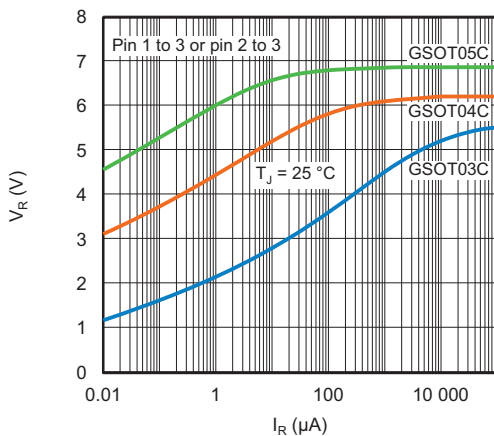

Fig. 3 - Typical Reverse Voltage  $V_R$  vs. Reverse Current  $I_R$

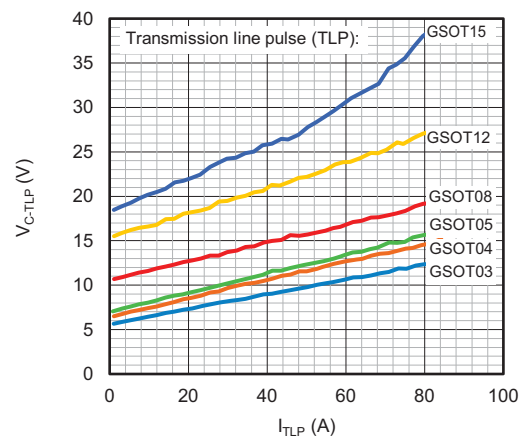

Fig. 6 - Typical Clamping Voltage vs. Peak Pulse Current

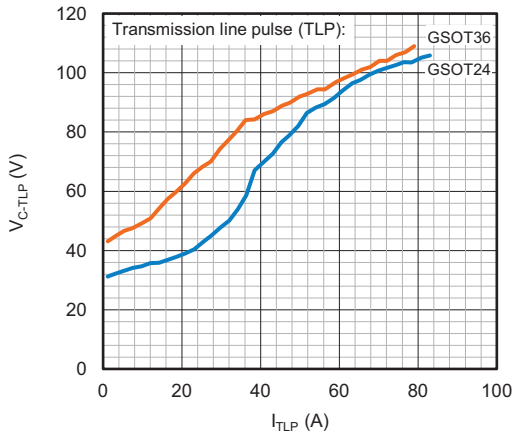

Fig. 7 - Typical Clamping Voltage vs. Peak Pulse Current

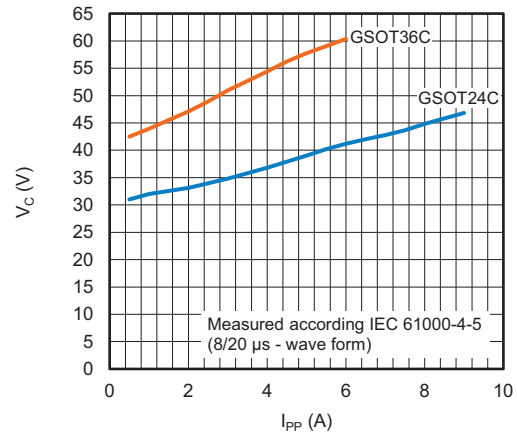

Fig. 9 - Typical Peak Clamping Voltage vs. Peak Pulse Current

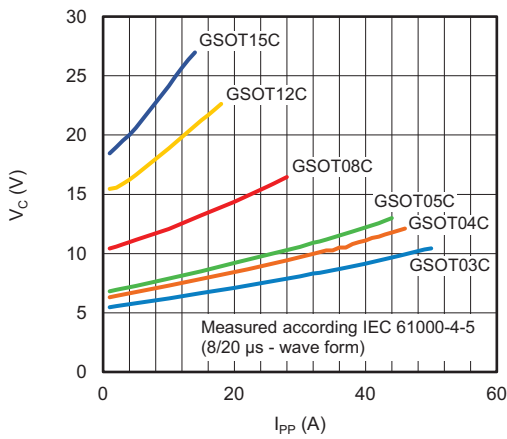

Fig. 8 - Typical Peak Clamping Voltage vs. Peak Pulse Current

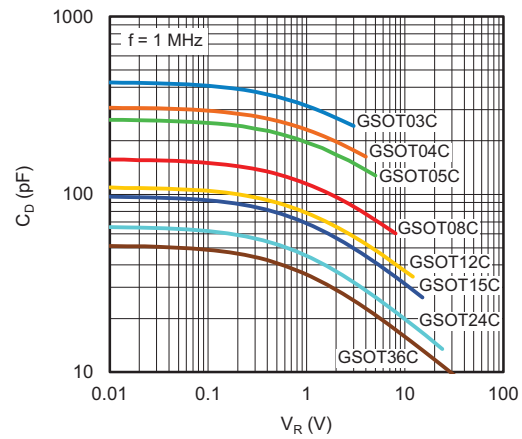
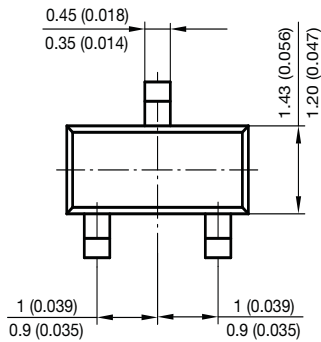
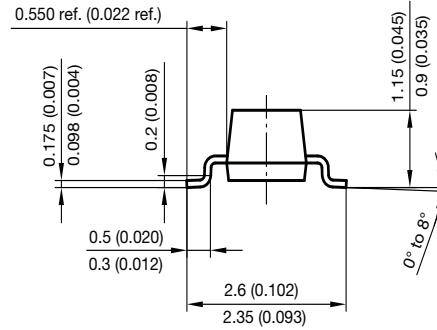
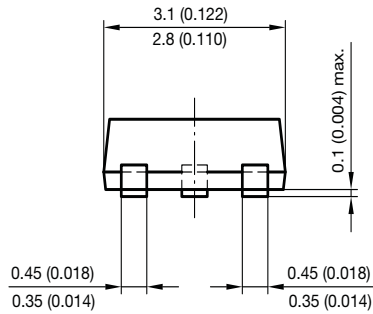

Fig. 10 - Typical Capacitance vs. Reverse Voltage



### PACKAGE DIMENSIONS in millimeters (inches): SOT-23



Foot print recommendation:

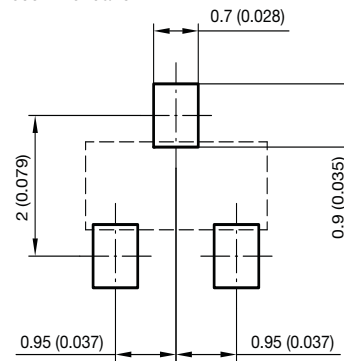

Document no.: 6.541-5014.01-4  
 Rev. 8 - Date: 23. Sep. 2009  
 17418

Orientation in carrier tape  
 SOT-23  
 S8-V-3929.01-006 (4)  
 04.02.2010  
 22607

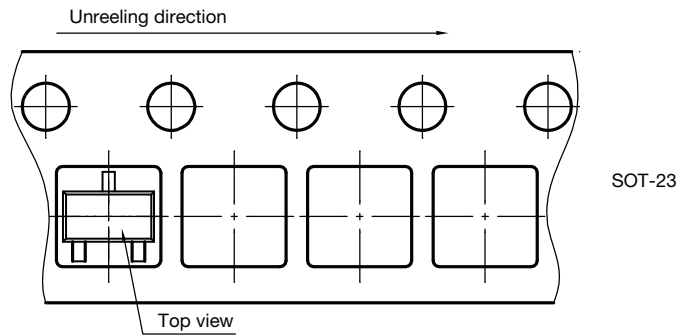



## Disclaimer

ALL PRODUCT, PRODUCT SPECIFICATIONS AND DATA ARE SUBJECT TO CHANGE WITHOUT NOTICE TO IMPROVE RELIABILITY, FUNCTION OR DESIGN OR OTHERWISE.

Vishay Intertechnology, Inc., its affiliates, agents, and employees, and all persons acting on its or their behalf (collectively, "Vishay"), disclaim any and all liability for any errors, inaccuracies or incompleteness contained in any datasheet or in any other disclosure relating to any product.

Vishay makes no warranty, representation or guarantee regarding the suitability of the products for any particular purpose or the continuing production of any product. To the maximum extent permitted by applicable law, Vishay disclaims (i) any and all liability arising out of the application or use of any product, (ii) any and all liability, including without limitation special, consequential or incidental damages, and (iii) any and all implied warranties, including warranties of fitness for particular purpose, non-infringement and merchantability.

Statements regarding the suitability of products for certain types of applications are based on Vishay's knowledge of typical requirements that are often placed on Vishay products in generic applications. Such statements are not binding statements about the suitability of products for a particular application. It is the customer's responsibility to validate that a particular product with the properties described in the product specification is suitable for use in a particular application. Parameters provided in datasheets and / or specifications may vary in different applications and performance may vary over time. All operating parameters, including typical parameters, must be validated for each customer application by the customer's technical experts. Product specifications do not expand or otherwise modify Vishay's terms and conditions of purchase, including but not limited to the warranty expressed therein.

Except as expressly indicated in writing, Vishay products are not designed for use in medical, life-saving, or life-sustaining applications or for any other application in which the failure of the Vishay product could result in personal injury or death. Customers using or selling Vishay products not expressly indicated for use in such applications do so at their own risk. Please contact authorized Vishay personnel to obtain written terms and conditions regarding products designed for such applications.

No license, express or implied, by estoppel or otherwise, to any intellectual property rights is granted by this document or by any conduct of Vishay. Product names and markings noted herein may be trademarks of their respective owners.