



SPECIFICATION SHEET

SPECIFICATION SHEET NO.	N0824-SMBJ14CA00S0BK
DATE	Aug. 24, 2021
REVISION	A0
DESCRIPTION	<p>SMD Transient Voltage Suppressor (TVs) Diodes, SMB/DO-214AA series, SMBJ14CA Type, 2 Pads, Bidirectional Type</p> <p>Stand-off Voltage 14V Max. Peak Pulse Power: 600 Watts Min.</p> <p>Operating Temp. Range -65°C ~+150°C</p> <p>Package in Tape/Reel, 3000pcs/Reel</p> <p>RoHS/RoHS III compliant</p>
CUSTOMER	
CUSTOMER PART NUMBER	
CROSS REF. PART NUMBER	
ORIGINAL PART NUMBER	MDD SMBJ14CA
PART CODE	SMBJ14CA00S0BK

VENDOR APPROVE			
Issued/Checked/Approved			
Date: Aug. 24, 2021			

CUSTOMER APPROVE
DATE:

SMD TRANSIENT VOLTAGE SUPPRESSORS DIODES SMB SERIES



MAIN FEATURE

- The plastic package carries Underwriters Laboratory Flammability Classification 94V-0
- Low profile package
- Built-in strain relief
- High temperature soldering guaranteed: 260°C/ 10 seconds at terminals
- Glass passivated chip junction
- Low inductance
- Excellent clamping capability
- 600W peak pulse power capability at 10/1000µs waveform
- Repetition rate (duty cycle): 0.01%
- Fast response time
- Repetition rate (duty cycle): 0.01%
- Typical IR less than 1µA above 10V

APPLICATION

- I/O interface
- AC/DC power supply
- Low frequency signal transmission line (RS232, RS485, etc.)

RFQ

[Request For Quotation](#)

PART CODE GUIDE

SMB	J14CA00	S	OBK
1	2	3	4

- 1) **SMB**: SMD Transient Voltage Suppressor (TVs) Diodes, SMB /DO-214AA series,
- 2) **J14CA00**: Type code for original part number SMBJ14CA
- 3) **S**: Package code, Tape/reel, 3000pcs/reel.
- 4) **OBK**: Marking code for “BK” on the case surface, Different Marking for different specification.

SMD TRANSIENT VOLTAGE SUPPRESSORS DIODES SMB SERIES

MORE ITEMS AVAILABLE- Unidirectional Type

SMBJ050A00S0KE	SMBJ060A00S0KG	SMBJ065A00S0KK	SMBJ070A00S0KM	SMBJ075A00S0KP
SMBJ080A00S0KR	SMBJ085A00S0KT	SMBJ090A00S0KV	SMBJ10A000S0KX	SMBJ11A000S0KZ
SMBJ12A000S0LE	SMBJ13A000S0LG	SMBJ14A000S0LK	SMBJ15A000S0LM	SMBJ16A000S0LP
SMBJ17A000S0LR	SMBJ18A000S0LT	SMBJ20A000S0LV	SMBJ22A000S0LX	SMBJ24A000S0LZ
SMBJ26A000S0ME	SMBJ28A000S0MG	SMBJ30A000S0MK	SMBJ33A000S0MM	SMBJ36A000S0MP
SMBJ40A000S0MR	SMBJ43A000S0MT	SMBJ45A000S0MV	SMBJ48A000S0MX	SMBJ51A000S0MZ
SMBJ54A000S0NE	SMBJ58A000S0NG	SMBJ60A000S0NK	SMBJ64A000S0NM	SMBJ70A000S0NP
SMBJ75A000S0NR	SMBJ78A000S0NT	SMBJ85A000S0NV	SMBJ90A000S0NX	SMBJ100A00S0NZ
SMBJ110A00S0PE	SMBJ120A00S0PG	SMBJ130A00S0PK	SMBJ150A00S0PM	SMBJ160A00S0PP
SMBJ170A00S0PR	SMBJ180A00S0PT	SMBJ190A00S0PA	SMBJ200A00S0PV	SMBJ210A00S0PB
SMBJ220A00S0PX	SMBJ250A00S0PZ	SMBJ300A00S0QE	SMBJ350A00S0QG	SMBJ400A00S0QK
SMBJ440A00S0QM				

MORE ITEMS AVAILABLE- Bidirectional Type

SMBJ050CA0S0AE	SMBJ060CA0S0AG	SMBJ065CA0S0AK	SMBJ070CA0S0AM	SMBJ075CA0S0AP
SMBJ080CA0S0AR	SMBJ085CA0S0AT	SMBJ090CA0S0AV	SMBJ10CA00S0AX	SMBJ11CA00S0AZ
SMBJ12CA00S0BE	SMBJ13CA00S0BG	SMBJ14CA00S0BK	SMBJ15CA00S0BM	SMBJ16CA00S0BP
SMBJ17CA00S0BR	SMBJ18CA00S0BT	SMBJ20CA00S0BV	SMBJ22CA00S0BX	SMBJ24CA00S0BZ
SMBJ26CA00S0CE	SMBJ28CA00S0CG	SMBJ30CA00S0CK	SMBJ33CA00S0CM	SMBJ36CA00S0CP
SMBJ40CA00S0CR	SMBJ43CA00S0CT	SMBJ45CA00S0CV	SMBJ48CA00S0CX	SMBJ51CA00S0CZ
SMBJ54CA00S0CE	SMBJ58CA00S0DG	SMBJ60CA00S0DK	SMBJ64CA00S0DM	SMBJ70CA00S0DP
SMBJ75CA00S0DR	SMBJ78CA00S0DT	SMBJ85CA00S0DV	SMBJ90CA00S0DX	SMBJ100CA0S0DZ
SMBJ110CA0S0EE	SMBJ120CA0S0EG	SMBJ130CA0S0EK	SMBJ150CA0S0EM	SMBJ160CA0S0EP
SMBJ170CA0S0ER	SMBJ180CA0S0ET	SMBJ190CA0S0EC	SMBJ200CA0S0EV	SMBJ210CA0S0ED
SMBJ220CA0S0EX	SMBJ250CA0S0EZ	SMBJ300CA0S0FE	SMBJ350CA0S0FG	SMBJ400CA0S0FK
SMBJ440CA0S0FM				

SMD TRANSIENT VOLTAGE SUPPRESSORS DIODES SMB SERIES

DIMENSION (Unit: Inch/mm)

Image for reference



Marking: BK

SMB/DO-214AA

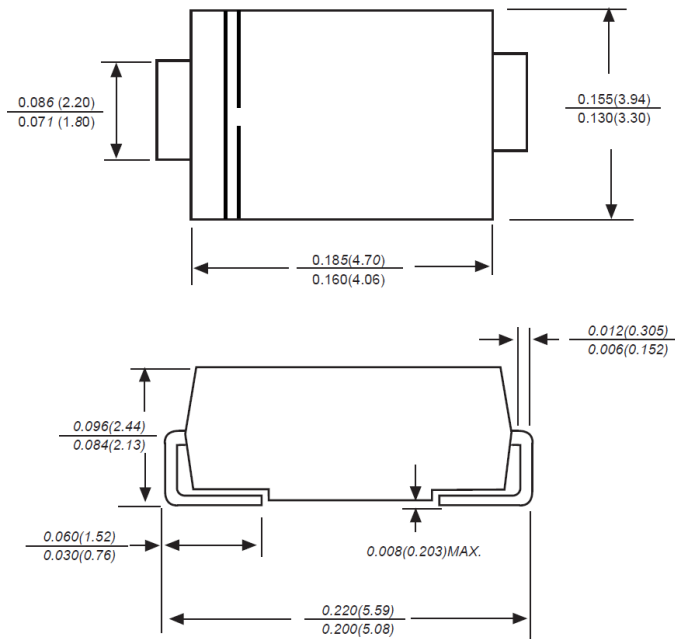

Recommend Pad Layout



Symbol	Unit (inch)	Unit (mm)
A	0.110	2.80
B	0.094	2.40
C	0.181	4.60
D	0.086	2.20
E	0.276	7.00

SMD TRANSIENT VOLTAGE SUPPRESSORS DIODES SMB SERIES

MECHANICAL DATA

Case	Terminals	Polarity	Mounting Position	Weight per piece
JEDEC SMB/DO-214AA molded plastic body	Solder plated, Solderable per MIL-STD-750, Method 2026	Polarity symbol marking on case	Any	0.0030 Ounce, 0.0850 grams

MAX. RATING & CHARACTERISTICS - Ratings at 25°C ambient temperature unless otherwise specified.

Parameter	SYMBOLS	VALUE			UNITS
		Min.	Typical	Max.	
Peak pulse power dissipation at 10/1000µs waveform (Note1, Note2, Fig.1)	P ppm	600			W
Peak pulse current of at 10/1000µs waveform (Note 1, Fig.3)	I ppm			25.9	A
Steady state power dissipation at TA=50°C (Fig.5)	P M(AV)		5.0		W
Peak forward surge current 8.3ms single half sine-wave superimposed on rated load (JEDEC Method) (Note3, Fig.6)	I FSM		100		A
Thermal resistance junction to lead	R QJL		20		°C/W
Thermal resistance junction to ambient	R QJA		100		°C/W
Operating junction temperature range	T J	-65		+150	°C
Storage temperature range	T STG	-65		+150	°C

Note

1. Non-repetitive current pulse, per Fig 3 and derated above TA=25 °C per Fig 2
2. Mounted on 5.0*5.0mm(Thickness 0.03mm) copper pads to each terminal
3. 8.3ms single half sine – wave or equivalent square wave, duty cycle – 4 pulsed per minute Max

ELECTRICAL CHARACTERISTICS - Ratings at 25°C

Parameter	SYMBOLS	VALUE	UNITS
Reverse Stand-Off Voltage	V RWM	14	V
Breakdown Voltage @I T	V BR	15.60~17.20	V
Test Current	I T	1	mA
Maximum Clamping Voltage @I PP	V C	23.2	V
Peak Pulse Current	I PP	25.9	A
Reverse Leakage @V RWM	I R	1	µA

SMD TRANSIENT VOLTAGE SUPPRESSORS DIODES SMB SERIES

RELIABILITY

Number	Experiment Items	Experiment Method And Conditions	Reference Documents
1	Solder Resistance Test	Test 260°C± 5°C for 10 ± 2 sec. Immerse body into solder 1/16" ± 1/32"	MIL-STD-750D METHOD-2031.2
2	Solderability Test	230°C ±5°C for 5 sec.	MIL-STD-750D METHOD-2026.1 0
3	Pull Test	1 kg in axial lead direction for 10 sec.	MIL-STD-750D METHOD-2036.4
4	Bend Test	0.5Kg Weight Applied To Each Lead, Bending Arcs 90 °C ± 5 °C For 3 Times	MIL-STD-750D METHOD-2036.4
5	High Temperature Reverse Bias Test	TA=100°C for 1000 Hours at VR=80% Rated VR	MIL-STD-750D METHOD-1038.4
6	Forward Operation Life Test	TA=25°C Rated Average Rectified Current	MIL-STD-750D METHOD-1027.3
7	Intermittent Operation Life Test	On state: 5 min with rated IRMS Power Off state: 5 min with Cool Forced Air. On and off for 1000 cycles.	MIL-STD-750D METHOD-1036.3
8	Pressure Cooker Test	15 PSIG, TA=121°C, 4 hours	MIL-S-19500 APPENOIXC
9	Temperature Cycling Test	-55°C~+125°C; 30 Minutes For Dwelled Time 5 minutes for transferred time. Total: 10 cycles.	MIL-STD-750D METHOD-1051.7
10	Thermal Shock Test	0°C for 5 minutes., 100°C for 5minutes, Total: 10 cycles	MIL-STD-750D METHOD-1056.7
11	Forward Surge Test	8.3ms Single Sale Sine-wave One Surge.	MIL-STD-750D METHOD-4066.4
12	Humidity Test	TA=65°C, RH=98% for 1000 hours.	MIL-STD-750D METHOD-1021.3
13	High Temperature Storage life Test	150°C for 1000 Hours	MIL-STD-750D METHOD-1031.5

SMD TRANSIENT VOLTAGE SUPPRESSORS DIODES SMB SERIES

SUGGESTED REFLOW PROFILE (For Reference Only)



Profile Feature		Pb-Free Assembly
Average Ramp-up Rate (T_s Max to T_p)		3°C/second Max
Preheat	Temperature Min (T_s Min.)	150°C
	Temperature Max (T_s Max.)	200°C
	Time (t_s Min. to t_s Max.)	60 ~ 180 seconds
Time maintained above	Temperature (T_L)	217°C
	Time (t_L)	60 ~ 150 seconds
Peak/Classification Temperature (T_p)		260 °C
Time within 5°C of actual Peak Temperature (t_p)		20 ~ 40 seconds
Ramp-down rate		6 °C /Second Max.
Time 25 °C to Peak Temperature		8 minutes Max.
Suggest reflow times		3 Times Max.

SMD TRANSIENT VOLTAGE SUPPRESSORS DIODES SMB SERIES

RATINGS AND CHARACTERISTIC CURVES (For Reference Only)

Figure 1. Peak Pulse Power Rating Curve



Figure 2. Pulse Derating Curve

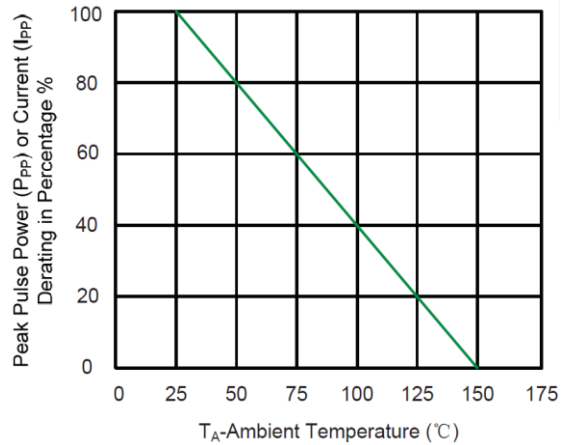

Figure 3. Pulse Waveform



Figure 4. Typical Junction Capacitance

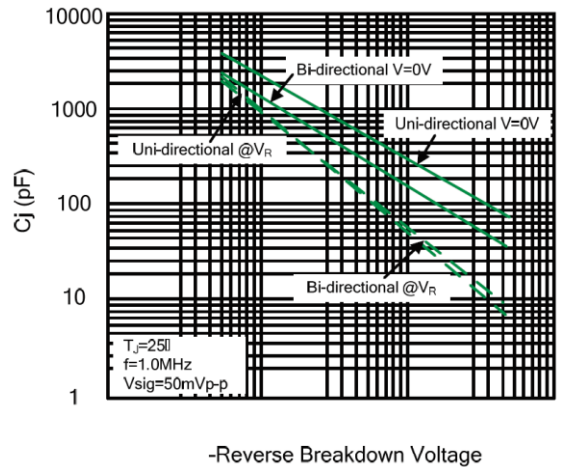

Figure 5. Steady State Power Dissipation Derating curve

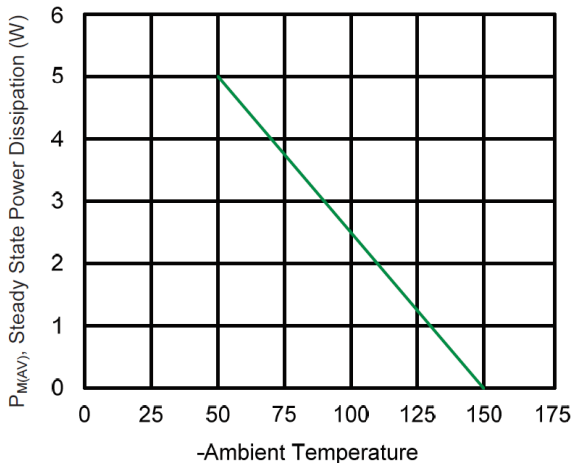

Figure 6. Maximum Non-Repetitive Forward Surge Current Uni-Directional Only



SMD TRANSIENT VOLTAGE SUPPRESSORS DIODES SMB SERIES

TAPE/REEL (Unit: mm)

All Devices are packed in accordance with EIA standard RS-481-A and specifications.



Item	Symbol	Tolerance	SMB/DO-214AA
Carrier width	A	0.1	3.81
Carrier Length	B	0.1	5.41
Carrier Depth	C	0.1	2.42
Sprocket hole	d	0.05	1.50
13" Reel outside diameter	D	2.0	330.00
13" Reel inner diameter	D1	Min.	50.00
7" Reel outside diameter	-	-	-
7" Reel inner diameter	-	-	-
Feed hole diameter	D2	0.5	13.00
Sprocket hole position	E	0.1	1.75
Punch hole position	F	0.1	5.55
Punch hole pitch	P	0.1	8.00
Sprocket hole pitch	P0	0.1	4.00
Embossment center	P1	0.1	2.00
Overall tape thickness	T	0.1	0.30
Tape width	W	0.3	12.00
Reel width	W1	1.0	12.30

SMD TRANSIENT VOLTAGE SUPPRESSORS DIODES SMB SERIES

PACKAGE

Case Code	Reel Size	MPQ (pcs)	Component Spacing (mm)	Qty. Per Box (pcs)	Inner Box L*W*H (mm)	Reel Size (mm)	Carton size L*W*H (mm)	Qty. Per Carton (pcs)	G. W (kg)
SMB	13"	3,000		3,000	335*335*40	330	380*380*380	48,000	13.0



DISCLAIMER

NextGen Component, Inc. reserves the right to make changes to the product(s) and or information contained herein without notice. No liability is assumed as a result of their use or application. No rights under any patent accompany the sale of any such product(s) or information