

NOTES: UNLESS OTHERWISE SPECIFIED

- | | |
|---------|--|
| NOTICE: | THIS IS A RoHS COMPLIANT COMPONENT/PRODUCT. ALL ENGINEERING CHANGES MUST HAVE PRIOR APPROVAL BY THE DESIGN CENTER. |
| RoHS |  |
- HEADER: THERMOSET PLASTIC MATERIAL WITH FLAMMABILITY RATING UL 94V-0 OR BETTER.
- SOLDERABILITY: CONFORMS TO ANSI/J-STD-002, IPC/EIA J-STD-003A.
- OPERATING TEMPERATURE: 0°C TO +70°C
- STORAGE TEMPERATURE: -20°C TO +125°C
- JEDEC MOISTURE: LEVEL 1.
- DIMENSIONS ARE IN INCHES [MILLIMETERS] WITH THE FOLLOWING TOLERANCES: [MILLIMETERS] ARE FOR REFERENCE ONLY.
.XX = ±.01 [0.25]
.XXX = ±.005 [0.13]

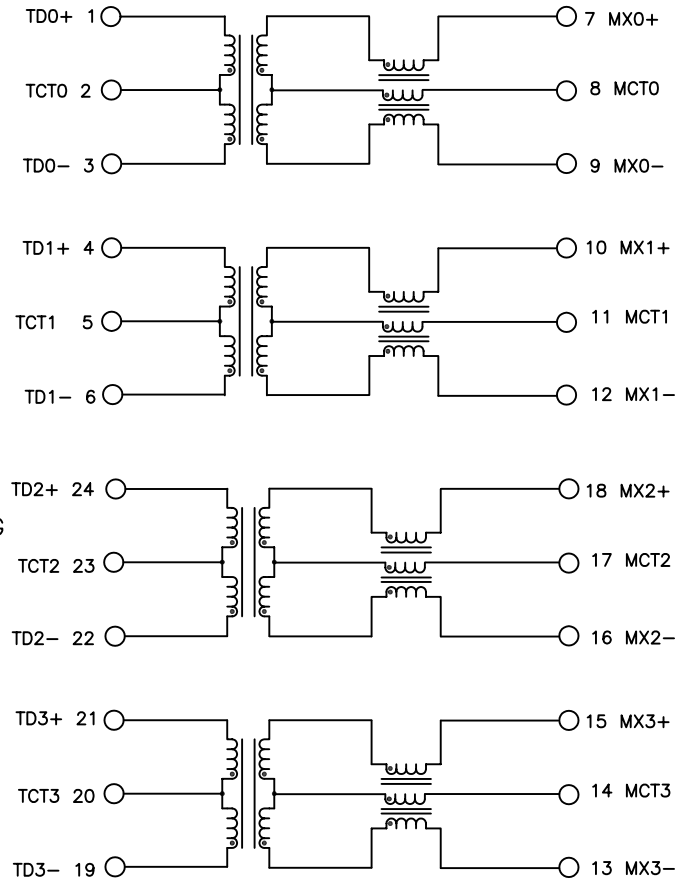

SCHEMATIC
EACH PORT

ELECTRICAL CHARACTERISTICS AT +25°C UNLESS OTHERWISE SPECIFIED
(FOR REFERENCE ONLY. USED FOR CUSTOMER INFORMATION.)

PARAMETER	SPECIFICATIONS	
OPERATING TEMP	0°C - 70 °C	
TURNS RATIO	1 : 1 ±2%	
POLARITY	PER SCHEMATIC	
INSERTION LOSS	100 KHz	1-125 MHz
	-1.2 dB MAX	-0.2-0.002*f ^{1.4} dB MAXIMUM
RETURN LOSS (Z OUT=100 OHM ±15%)	.1-40 MHz	40-100 MHz
	-16 dB MIN	-10+20*LOG ₁₀ (f/80 MHz) dB MINIMUM
INDUCTANCE (OCL) (MEDIA SIDE, 0°C-70°C)	350 uH MIN (MEASURED AT 100 KHz, 100 mVRMS AND WITH 8 mA DC BIAS)	
CROSSTALK, ADJACENT CHANNELS	1 MHz	10-100 MHz
	-50 dB MIN	-55+22*LOG ₁₀ (f/10) dB MINIMUM
COMMON MODE REJECTION RATIO	2 MHz	30-200 MHz
	-50 dB MIN	-15+20*LOG ₁₀ (f/200) dB MINIMUM
DC RESISTANCE, 1/2 WINDING	.65 OHMS MAXIMUM	
DC RESISTANCE IMBALANCE	±.065 OHMS MAXIMUM (CENTER TAP SYMMETRY)	
INPUT - OUTPUT ISOLATION	1500 VRMS MINIMUM AT 60 SECONDS	

NOTE: f IS FREQUENCY IN MHZ.

© Copyright, 2010. Pulse Electronics Corp. All rights reserved. Drawing specifications subject to change without notice. (12/14/10)

PULSE CONFIDENTIAL & PROPRIETARY	PRODUCT DESCRIPTION	PS DRAWING	SHEET:	DWG. NO./ PART NO.	REV.
	MDL,QUAD,1GD,1:1,SM,TY	PS-2435.001-D	1	H5401NL	M11

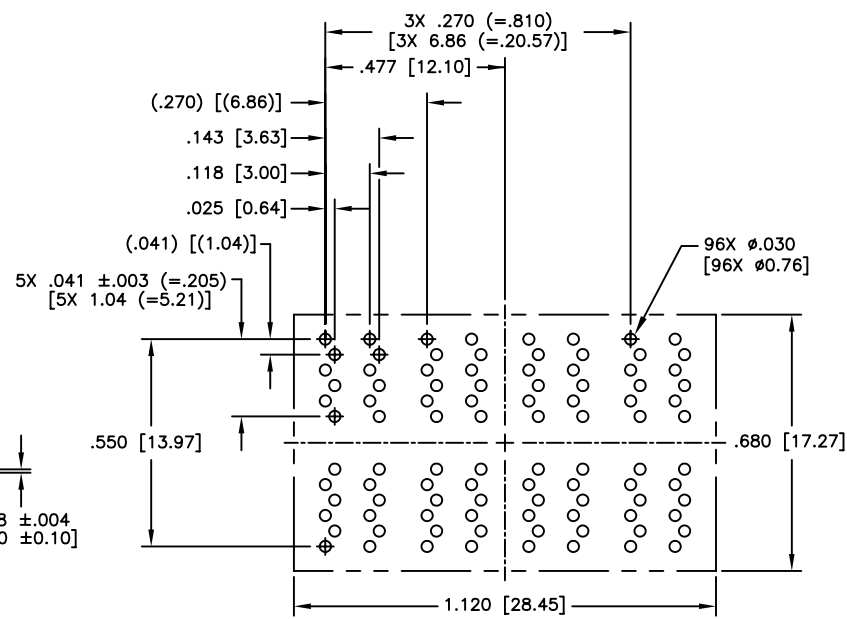
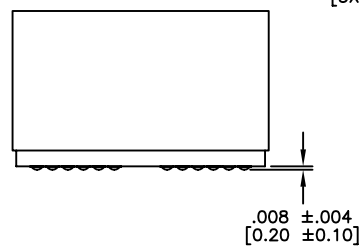
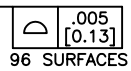
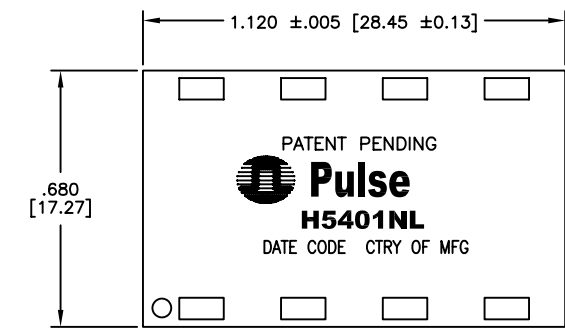

SUGGESTED PCB LAYOUT

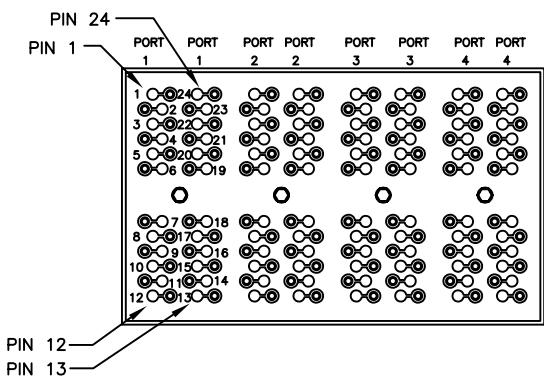

© Copyright, 2010. Pulse Electronics Corp. All rights reserved. Drawing specifications subject to change without notice. (12/14/10)

PULSE CONFIDENTIAL & PROPRIETARY	PRODUCT DESCRIPTION	PS DRAWING	SHEET:	DWG. NO./ PART NO.	REV.
	MDL,QUAD,1GD,1:1,SM,TY	PS-2435.001-D	2	H5401NL	M11