

NCP5252

Buck Regulator - Integrated, Synchronous, Light Load Efficiency

2.0 A, 1.0 MHz

NCP5252 is a synchronous buck regulator with integrated high-side and low-side MOSFETs. The device is capable of operating from a 5 V or 12 V supply and can output a voltage down to 0.6 V. The switching frequency is adjustable from 333 kHz up to 1.0 MHz and has the ability to provide skip mode for light load efficiency. NCP5252 protection features include Under Voltage Lock Out (UVLO), Over Voltage Protection (OVP), Cycle-by-Cycle Current Protection (OCP) and Thermal Shutdown. The part is packaged in a 3x3 mm QFN-16.

Features

- 1% Accuracy 0.6 V Reference
- V_{CC} Voltage 4.5 V to 13.2 V
- Adjustable Output Voltage Range: 0.6 V to 5.0 V
- Transient Response Enhancement (TRE) Feature.
- Low Side Lossless Sense Current Control
- Input Voltage Feed Forward Control
- Internal Digital Soft-Start
- Integrated Output Discharge (Soft-Stop)
- Cycle-by-Cycle Current Limit
- Power Good Indication
- Overvoltage and Undervoltage Protection
- Thermal Shutdown Protection
- Power Saving Mode at Light Load
- Integrated Boost Diode
- QFN-16 (3 mm x 3 mm)
- These Devices are Pb-Free and are RoHS Compliant

Typical Applications

- Desktop Application
- System Power
- XDSL, Modems, DC-DC Modules
- Set Top Box
- HD Driver
- LED Driver, DVD Recorders



ON Semiconductor®

<http://onsemi.com>

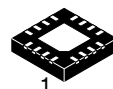

QFN16
CASE 485G

MARKING DIAGRAM

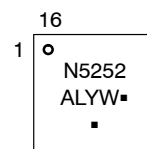

- A = Assembly Location
- L = Wafer Lot
- Y = Year
- W = Work Week
- = Pb-Free Package

(Note: Microdot may be in either location)

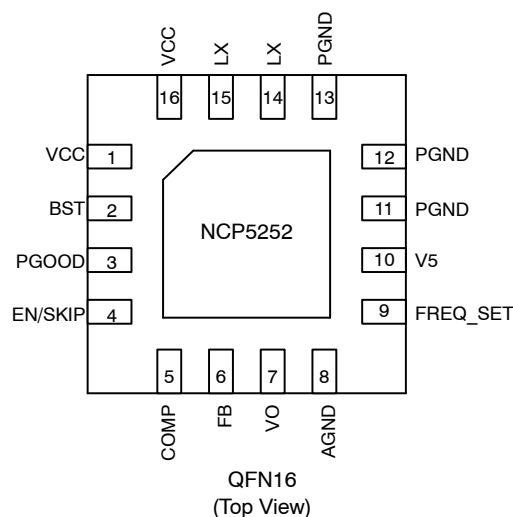

ORDERING INFORMATION

Device	Package	Shipping†
NCP5252MNTXG	QFN16 (Pb-Free)	3000 / Tape & Reel

†For information on tape and reel specifications, including part orientation and tape sizes, please refer to our Tape and Reel Packaging Specifications Brochure, BRD8011/D.

NCP5252

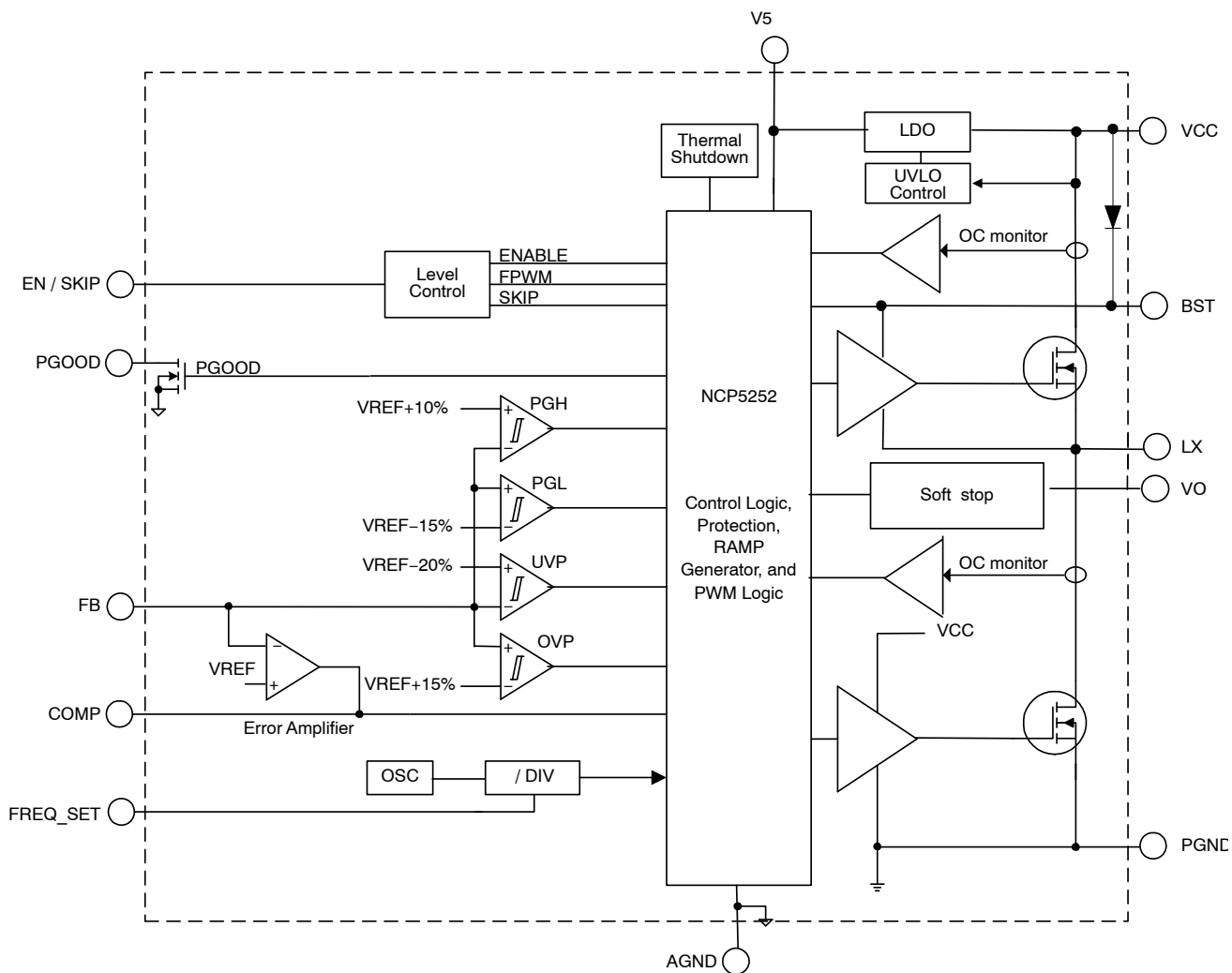

Figure 1. NCP5252 Typical Block Diagram

NCP5252

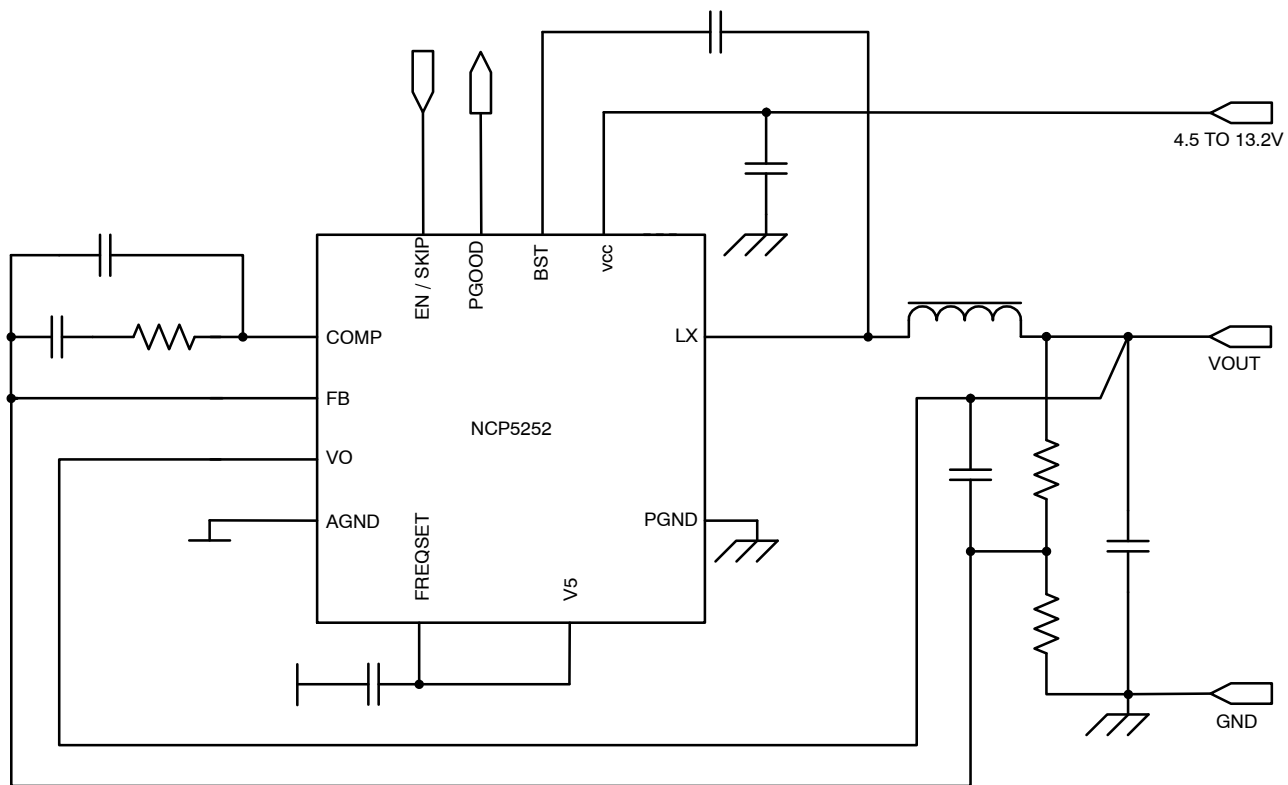

Figure 2. NCP5252 Typical Application Circuits

PIN FUNCTION DESCRIPTION

Pin No	Symbol	Description
1	V _{CC}	Internal LDO power supply
2	BST	Top MOSFET driver input supply, place a ceramic capacitor between LX and BST.
3	PGOOD	Output voltage power good indication. The power good pin is an open drain indication flag. The PGOOD pin is low impedance if the output voltage is outside the comparator window and is high impedance if the output voltage is inside the comparator window.
4	EN/SKIP	The enable pin is used to enable the part and also set skip mode or forced PWM.
5	COMP	Output of the error amplifier
6	FB	Output voltage feedback
7	VO	Output voltage monitor
8	AGND	Analog ground
9	FREQ_SET	Frequency selection pin, 0 V = 333k, No connect = 500 kHz, 5 V = 1.0 MHz
10	V5	Output to the internal power supply for the analog circuitry
11-13	PGND	Ground reference and high-current return path for the bottom power MOSFET.
14-15	LX	Switch node between the top MOSFET and bottom MOSFET.
16	V _{CC}	High Side MOSFET input voltage connection
17	EPAD	Connect to PGND for thermal enhancement. Exposed pad is not electrically connected.

NCP5252

ABSOLUTE MAXIMUM RATINGS

Rating	Symbol	Value	Unit
V _{CC} Power Supply Voltage to AGND	V _{CC}	-0.3, 15	V
EN / SKIP to AGND	V _{EN}	-0.3, 6	V
Bootstrap Supply Voltage: BST to LX	V _{BST} - V _{LX}	-0.3, 15	V
LDO regulator: V5 to AGND	V5 - V _{AGND}	-0.3, 6	V
Input / Output Pins to AGND	V _{IO}	-0.3, 6	V
Switch Node to PGND	V _{LX}	15 20 (50 ns) -1 (DC) -5 (200 ns)	V
PGND	V _{PGND}	-0.3, 0.3	V
Thermal Resistance Junction-to-Ambient (0 lfpm)	R _{θJA}	90	°C/W
Thermal Resistance Junction-to-Case (0 lfpm)	R _{θJC}	15	°C/W
Operating Ambient Temperature Range	T _A	-40 to + 85	°C
Operating Junction Temperature Range	T _J	-40 to + 150	°C
Storage Temperature Range	T _{stg}	-55 to +150	°C
Power Dissipation	P _D	1.4	W
Moisture Sensitivity Level	MSL	1	-

Stresses exceeding Maximum Ratings may damage the device. Maximum Ratings are stress ratings only. Functional operation above the Recommended Operating Conditions is not implied. Extended exposure to stresses above the Recommended Operating Conditions may affect device reliability.

V_{CC} UNDERVOLTAGE

Parameter	Test Conditions	Min	Typ	Max	Unit
V _{CC} UVLO Rise Threshold		4.1	4.3	4.5	V
V _{CC} UVLO Hysteresis		300	400	500	mV

NCP5252

ELECTRICAL CHARACTERISTICS ($V_{CC} = 4.5$ to 13.2 V, $T_A = -40^\circ\text{C}$ to 85°C , unless other noted)

Characteristics	Symbol	Test Conditions	Min	Typ	Max	Unit
-----------------	--------	-----------------	-----	-----	-----	------

SUPPLY VOLTAGE

Input Voltage	V_{CC}		4.5		13.2	V
POR Threshold for Internal Reset Logic	V_{CC_POR}			3.0	3.7	V

SUPPLY CURRENT

V_{CC} Quiescent Supply Current	I_{CC_FPWM}	EN/SKIP = 5 V, $V_{FB} = 1$ V (No switching), $V_{CC} = 4.5$ V to 13.2 V		1.0	2.5	mA
V_{CC} Shutdown Current	I_{VCC_SD}	EN/SKIP = 0 V			10	μA
BST Quiescent Supply Current	I_{BST_FPWM}	EN/SKIP = H, $V_{FB} = 1$ V, $V_{BST} = 5$ V			0.3	mA
BST Shut Down Current	I_{BST_SD}	EN/SKIP = L, $V_{FB} = 1$ V, $V_{BST} = 5$ V			10	μA
V_{CC} Input Current	I_{VCC}	FREQ_SET = AGND. FREQ = 333 kHz		18		mA

LDO REGULATOR

V5 Regulator Voltage	V5	$V_{CC} > 6$ V, $I_{V5} = 5$ mA	4.85	5.0	5.15	V
V5 Rise Threshold	$V5_th+$	Wake Up	4.1	4.3	4.45	V
V5 UVLO Hysteresis	$V5_{HYS}$		300	400	500	mV
V5 Loading	$V5_{LOAD}$				3.0	mA
V5 Current Limit	I_{LIMIT_V5}		20			mA
Drop-out Voltage ($V_{CC} - V5$)	V_{DR}	$I_o = 5$ mA, $T_A = 25^\circ\text{C}$, $V_{CC} = 4.5$ V, $FB = 1$ V			200	mV

POWER GOOD

Power Good High Threshold	VPGH	PGOOD in from higher V_o (PGOOD goes high)	100	110	120	%
Power Good High Hysteresis	VPGH_HYS	PGOOD high hysteresis (PGOOD goes low)		5		%
Power Good Low Threshold	VPGL	PGOOD in from lower V_o (PGOOD goes high)	75	85	95	%
Power Good Low Hysteresis	VPGL_HYS	PGOOD low hysteresis (PGOOD goes low)		-5		%
Power Good High Delay	T_d_PGH			150		μs
Power Good Low Delay	T_d_PGL			1.5		μs
Output Overvoltage Rising Threshold	OVPth+	$OVPth+ = VPGH + VPGH_SYS$	105	115	125	%
Over voltage Fault Propagation Delay	OVPTblk	FB Forced 2% above trip threshold		1.5		μs
Output Undervoltage Trip Threshold	UVPth	$UVPth = VPGL + VPGL_HYS$	70	80	90	%
Output Undervoltage Protection Blanking Time	UVPTblk			8.0		μs

REFERENCE OUTPUT

Internal Reference Voltage	V_{REF}	25°C -40°C to 85°C	0.594 0.591	0.6 0.6	0.606 0.609	V
Output Voltage Accuracy (Note 1)		$V_{IN} = 12$ V, $I_o = 0$ A to 2 A	-1	0	+1	%
Line Regulation (Note 1)		$V_{IN} = 5$ to 12 V, $I_{OUT} = 500$ mA		0.1		%/V

OSCILLATOR

Operation Frequency	F_{SW}	FREQ_SET = V5	900	1000	1100	kHz
		FREQ_SET = NC	450	500	550	kHz
		FREQ_SET = AGND	300	333	366	kHz

INTERNAL SOFT-START

Soft-Start Time	t_{SS}	Digital Soft-Start (V_{OUT} from 10% to 90%)		800		μs
-----------------	----------	---	--	-----	--	---------------

1. Guaranteed by design, not tested in production.
2. Test mode disables the T_{on}/T_{off} min.

NCP5252

ELECTRICAL CHARACTERISTICS ($V_{CC} = 4.5$ to 13.2 V, $T_A = -40^\circ\text{C}$ to 85°C , unless other noted)

Characteristics	Symbol	Test Conditions	Min	Typ	Max	Unit
-----------------	--------	-----------------	-----	-----	-----	------

SWITCHING MODULATOR

Minimum T_{on}	T_{on_min}	(Note 1)	40	50	60	ns
Minimum T_{off}	T_{off_min}	(Note 1)	200	225	250	ns
PWM Comparator Offset		(Note 1)		5.0	10	mV
Propagation Delay of PWM Comparator	TD_PWM	(Note 1)			20	ns

VOLTAGE ERROR AMPLIFIER

DC Gain	GAIN_VEA	(Note 1)	80	88		dB
Open-Loop Phase Margin	PH_EA	(Note 1)	50			Deg
Unity Gain Bandwidth	BW_VEA	(Note 1)	15	20		MHz
Slew Rate	SR_VEA	COMP PIN TO GND = 100 pF (Note 1)	5.0			V/ μ s
FB Bias Current	I_{bias_FB}				0.1	μ A
Output Voltage Swing	V_{max_EA}	$I_{source_EA} = 2\text{mA}$	3.3	3.5		V
	V_{min_EA}	$I_{sink_EA} = 2\text{mA}$		0.15	0.3	V

OVERCURRENT PROTECTION LIMIT

High Side Peak Current Limit (Cycle-by-Cycle)	HSOC	T_{on} Minimum > 100 ns (Notes 1 & 2)	3.4	4.0	4.6	A
Low Side Valley Current Limit, Short-Circuit (4 μ s)	LSOC_S	(Notes 1 & 2)	3.0	3.75	4.5	A
Low Side Valley Current Limit (Current Limit, 16 μ s)	LSOC_L	(Notes 1 & 2)	2.0	2.5	3.4	A

POWER OUTPUT SECTION

Internal Main FET ON-Resistance	$R_{DS(on)_M}$	($I_{LX} = 100\text{mA}$, $V_{BST-LX} = 5\text{V}$, $FB = 0$, $T_A = 25^\circ\text{C}$) (Note 1)		150	225	$\text{m}\Omega$
Internal Sync FET ON-Resistance	$R_{DS(on)_F}$	($I_{LX} = 100\text{mA}$, $FB = 1\text{V}$, $T_A = 25^\circ\text{C}$) (Note 1)		100	150	$\text{m}\Omega$
LX Leakage Current	LX_LK	$V_{EN} = 0\text{V}$, $LX = 0$, $V_{CC} = 13.2\text{V}$			+5.0	μ A
		$LX = 13.2$, $V_{CC} = 13.2\text{V}$			-5.0	μ A

CONTROL SECTION

EN / SKIP Logic Input Voltage for Disable	$V_{EN_DISABLE}$	Set as Disable	0.7	1.0	1.3	V
	V_{EN_HYS}	Hysteresis		300		mV
EN / SKIP Logic Input Voltage for FPWM	V_{EN_FPWM}	Set as FCCM mode	1.7	1.95	2.10	V
EN / SKIP Logic Input Voltage for Skip Mode	V_{EN_SKIP}	Set as SKIP Mode	2.25	2.45	2.65	V
	V_{EN_HYS}	Hysteresis		250		mV
EN / SKIP Source Current	I_{EN_SOURCE}	$V_{EN_SKIP} = 0\text{V}$			0.1	μ A
EN / SKIP Sink Current	I_{EN_SINK}	$V_{EN_SKIP} = 5\text{V}$			0.1	μ A
EN_SKIP Logic Input Delay		Change mode delay active		3		Clk
PGOOD Pin ON Resistance	PGOOD_R	$I_{PGOOD} = 5\text{mA}$		75		Ω
PGOOD Pin OFF Current	PGOOD_LK	PGOOD = 5 V			1	μ A

OUTPUT DISCHARGE MODE

Output Discharge On-Resistance	$R_{discharge}$	EN = 0 V		20	35	Ω
--------------------------------	-----------------	----------	--	----	----	----------

THERMAL SHUTDOWN

Thermal Shutdown	T_{sd}	(Note 1)		150		$^\circ\text{C}$
Thermal Shutdown Hysteresis	T_{sdhys}	(Note 1)		25		$^\circ\text{C}$

1. Guaranteed by design, not tested in production.
2. Test mode disables the T_{on}/T_{off} min.

TYPICAL OPERATING CHARACTERISTICS

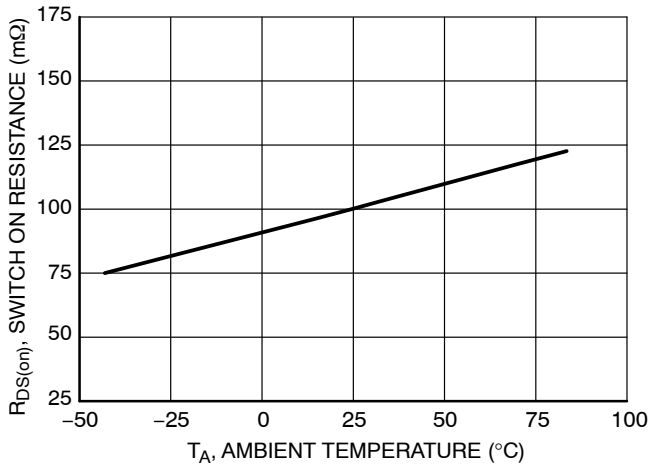

Figure 3. Sync FET ON Resistance vs. Temperature

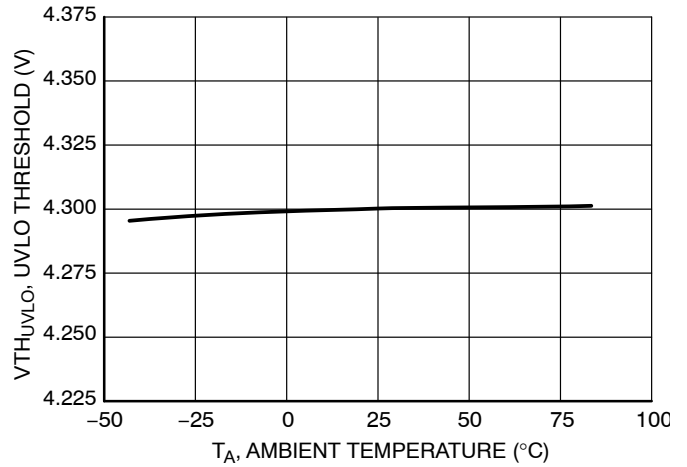

Figure 4. UVLO Threshold vs. Temperature

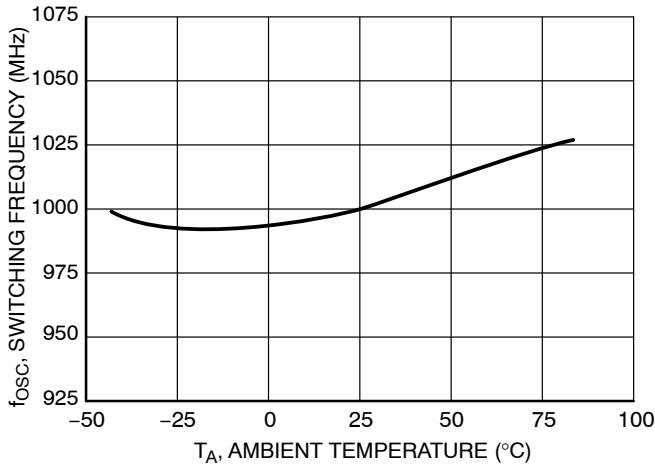

Figure 5. Switching Frequency vs. Temperature

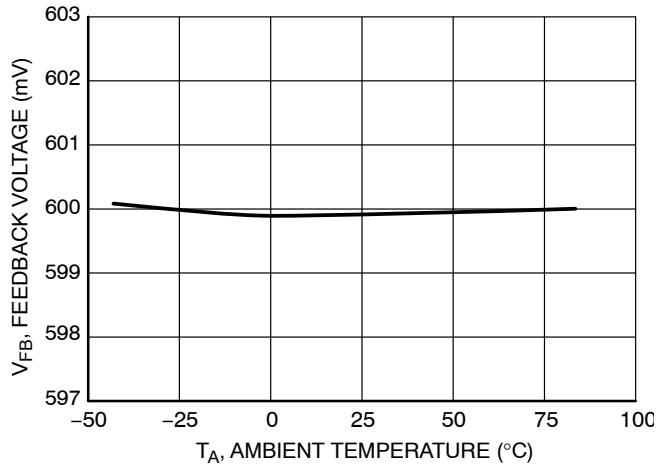

Figure 6. Feedback Input Threshold vs. Temperature

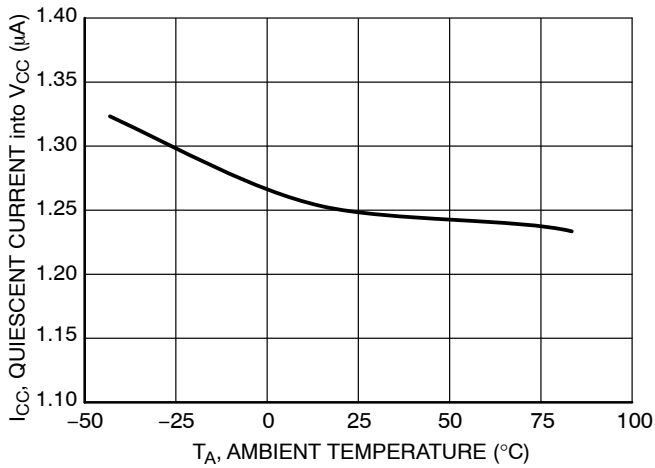

Figure 7. Quiescent Current into V_{CC} vs. Temperature

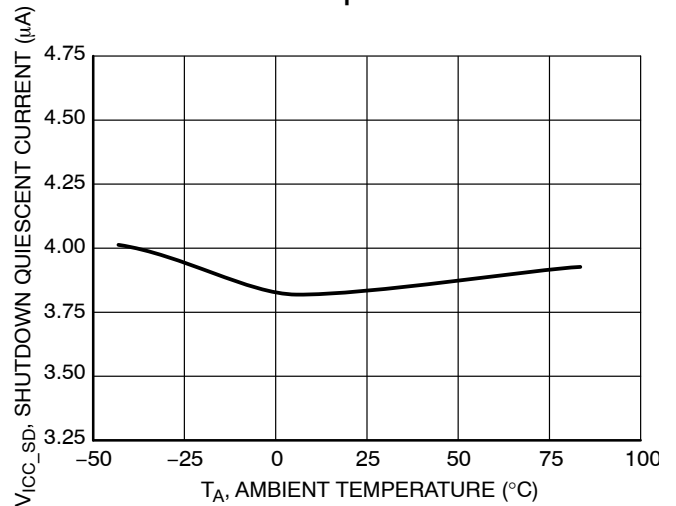

Figure 8. Shutdown Quiescent Current vs. Temperature

TYPICAL OPERATING CHARACTERISTICS

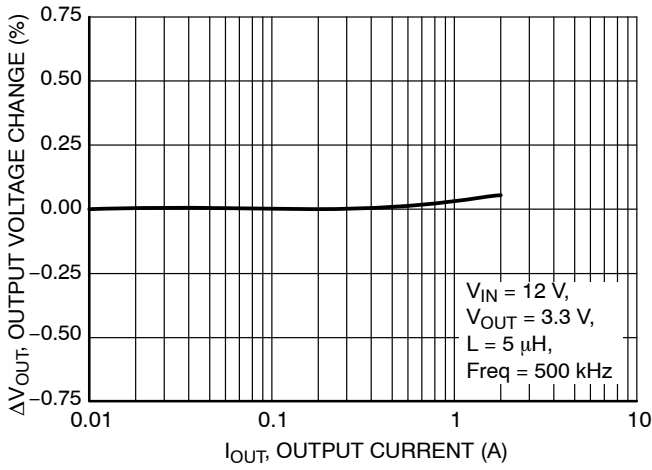

Figure 9. Output Voltage Change vs. Output Current

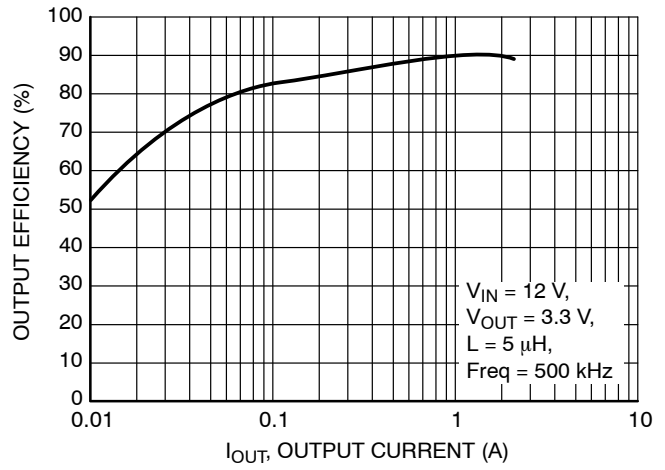

Figure 10. Efficiency vs. Output Current

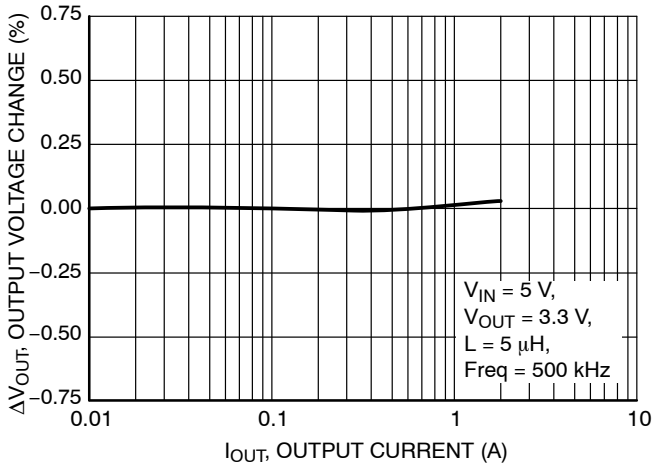

Figure 11. Output Voltage Change vs. Output Current

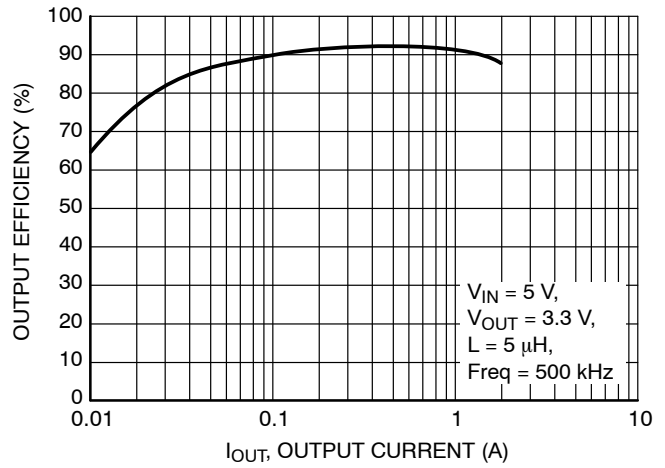

Figure 12. Efficiency vs. Output Current

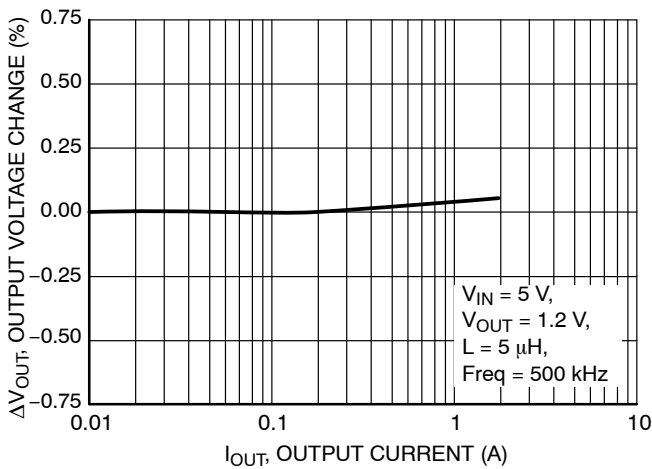

Figure 13. Output Voltage Change vs. Output Current

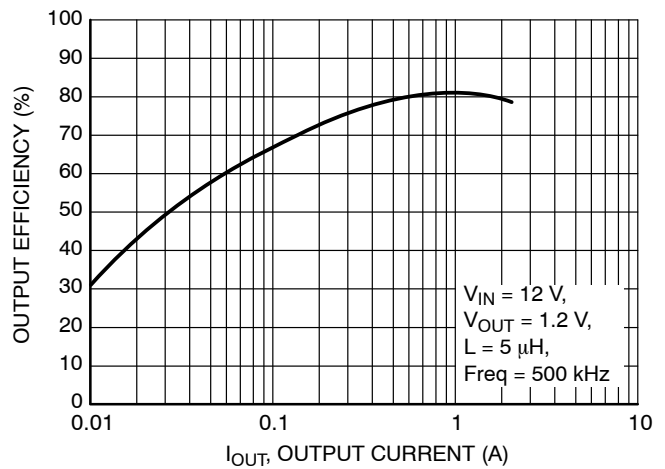
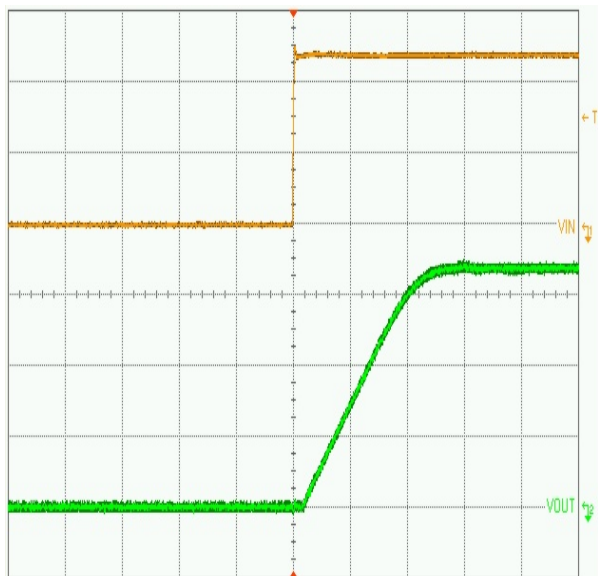
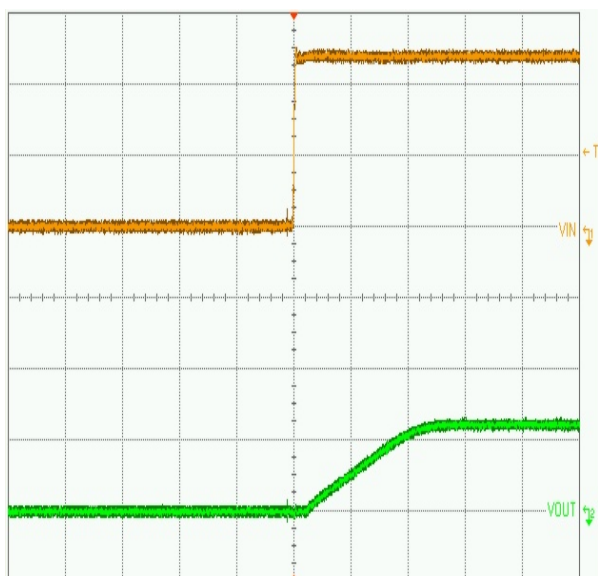

Figure 14. Efficiency vs. Output Current



($V_{in} = 12\text{ V}$, $I_{LOAD} = 10\text{ mA}$,
 $L = 5\text{ }\mu\text{H}$, $C_{OUT} = 100\text{ }\mu\text{F}$)
 Upper trace: Input voltage, 5 V/div
 Lower trace: Output voltage, 1 V/div
 Time base: 500 $\mu\text{s}/\text{div}$

Figure 15. Soft-Start Waveforms for $V_{out} = 3.3\text{ V}$



($V_{in} = 12\text{ V}$, $I_{LOAD} = 10\text{ mA}$,
 $L = 5\text{ }\mu\text{H}$, $C_{OUT} = 100\text{ }\mu\text{F}$)
 Upper trace: Input voltage, 5 V/div
 Lower trace: Output voltage, 1 V/div
 Time base: 500 $\mu\text{s}/\text{div}$

Figure 16. Soft-Start Waveforms for $V_{out} = 1.2\text{ V}$

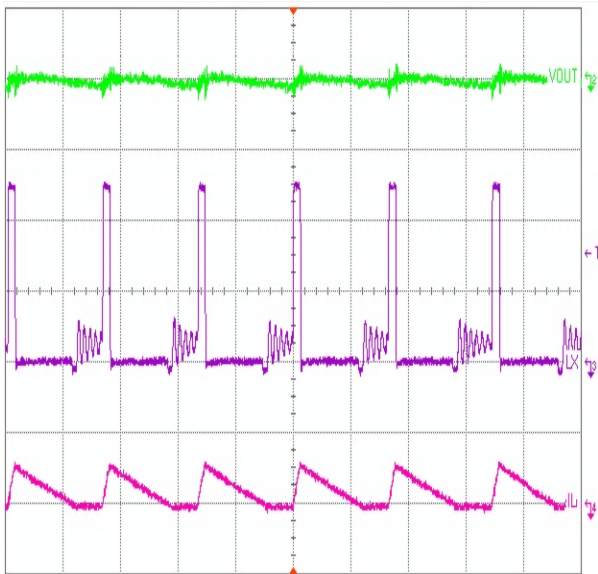

($V_{in} = 12\text{ V}$, $I_{LOAD} = 200\text{ mA}$, $L = 5\text{ }\mu\text{H}$, $C_{OUT} = 100\text{ }\mu\text{F}$)
 Upper trace: Output ripple voltage, 50 mV/div
 Middle trace: Lx pin switching waveform, 5 V/div
 Lower trace: Inductor current waveforms, 1 A/div
 Time base: 2 $\mu\text{s}/\text{div}$

Figure 17. DCM Switching Waveforms for $V_{out} = 1.2\text{ V}$

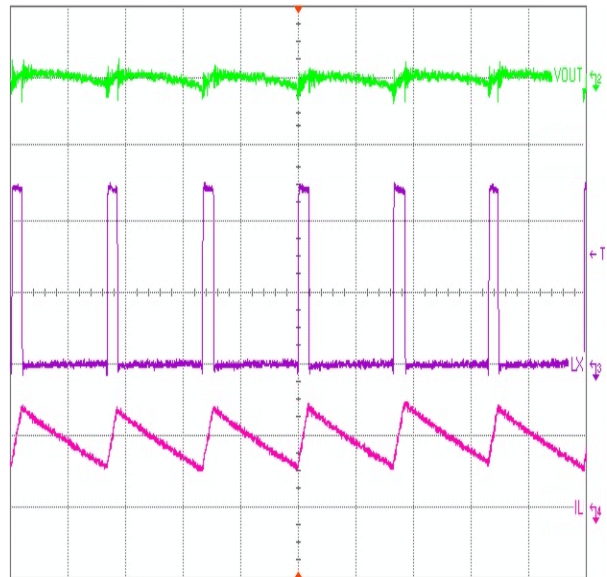

($V_{in} = 12\text{ V}$, $I_{LOAD} = 1\text{ A}$, $L = 5\text{ }\mu\text{H}$, $C_{OUT} = 100\text{ }\mu\text{F}$)
 Upper trace: Output ripple voltage, 50 mV/div
 Middle trace: Lx pin switching waveform, 5 V/div
 Lower trace: Inductor current waveforms, 1 A/div
 Time base: 2 $\mu\text{s}/\text{div}$

Figure 18. CCM Switching Waveforms for $V_{out} = 1.2\text{ V}$

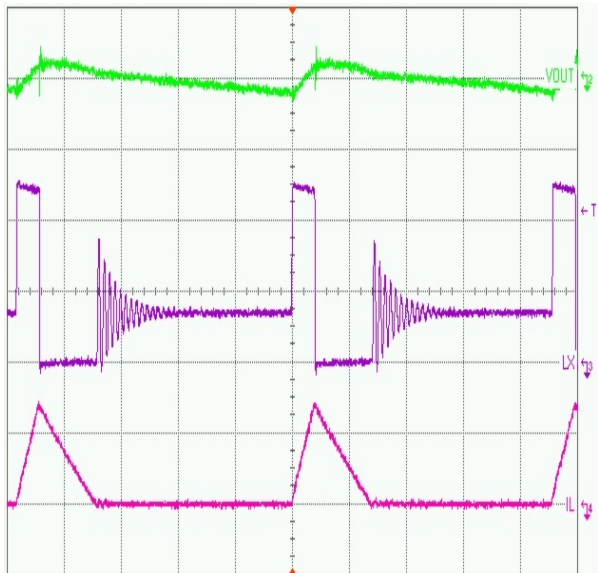

($V_{in} = 12\text{ V}$, $I_{LOAD} = 200\text{ mA}$, $L = 5\text{ }\mu\text{H}$, $C_{OUT} = 100\text{ }\mu\text{F}$)
 Upper trace: Output ripple voltage, 50 mV/div
 Middle trace: Lx pin switching waveform, 5 V/div
 Lower trace: Inductor current waveforms, 500 mA/div
 Time base: 2 $\mu\text{s}/\text{div}$

Figure 19. DCM Switching Waveforms for $V_{out} = 3.3\text{ V}$

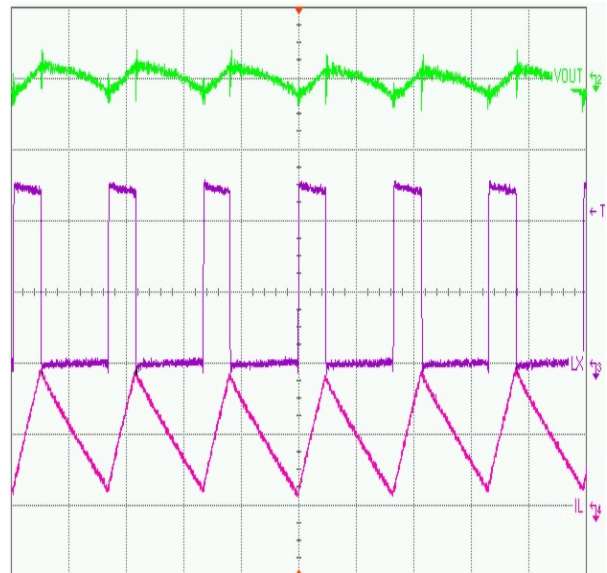

($V_{in} = 12\text{ V}$, $I_{LOAD} = 500\text{ mA}$, $L = 5\text{ }\mu\text{H}$, $C_{OUT} = 100\text{ }\mu\text{F}$)
 Upper trace: Output ripple voltage, 50 mV/div
 Middle trace: Lx pin switching waveform, 5 V/div
 Lower trace: Inductor current waveforms, 500 mA/div
 Time base: 2 $\mu\text{s}/\text{div}$

Figure 20. CCM Switching Waveforms for $V_{out} = 3.3\text{ V}$

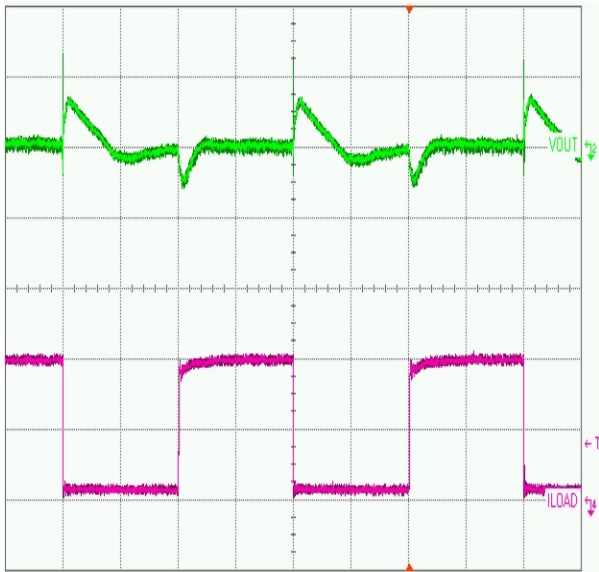

($V_{in} = 12\text{ V}$, $L = 5\ \mu\text{H}$, $C_{OUT} = 100\ \mu\text{F}$, $\text{Freq} = 500\ \text{kHz}$)
 Upper trace: Output dynamic voltage, 100 mV/div
 Lower trace: Output current, 1 A/div
 Time base : 50 $\mu\text{s}/\text{div}$

Figure 21. Load Transient Response for $V_{out} = 1.2\text{ V}$

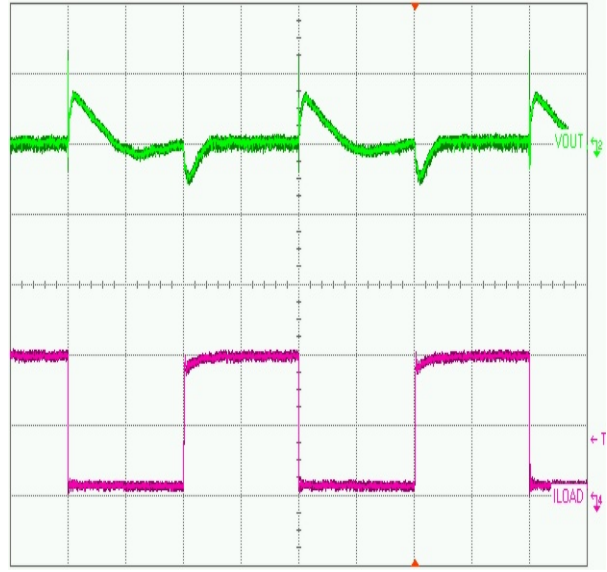

($V_{in} = 5\text{ V}$, $L = 5\ \mu\text{H}$, $C_{OUT} = 100\ \mu\text{F}$, $\text{Freq} = 1\ \text{MHz}$)
 Upper trace: Output dynamic voltage, 100 mV/div
 Lower trace: Output current, 1 A/div
 Time base : 50 $\mu\text{s}/\text{div}$

Figure 22. Load Transient Response for $V_{out} = 1.2\text{ V}$

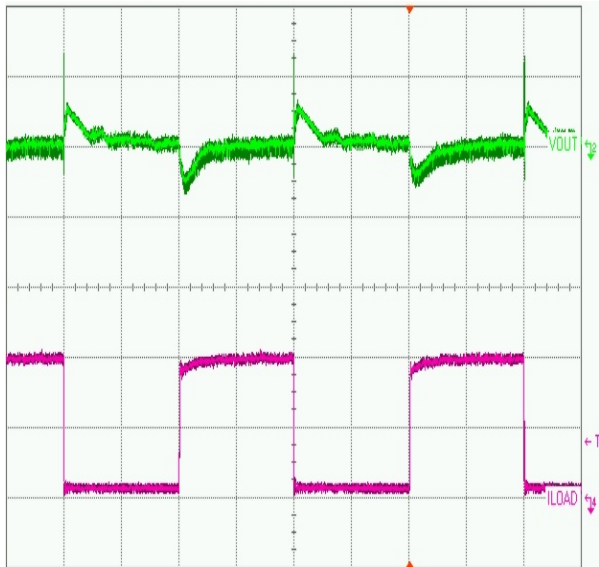

($V_{in} = 12\text{ V}$, $L = 5\ \mu\text{H}$, $C_{OUT} = 100\ \mu\text{F}$, $\text{Freq} = 1\ \text{MHz}$)
 Upper trace: Output dynamic voltage, 100 mV/div
 Lower trace: Output current, 1 A/div
 Time base : 50 $\mu\text{s}/\text{div}$

Figure 23. Load Transient Response for $V_{out} = 3.3\text{ V}$

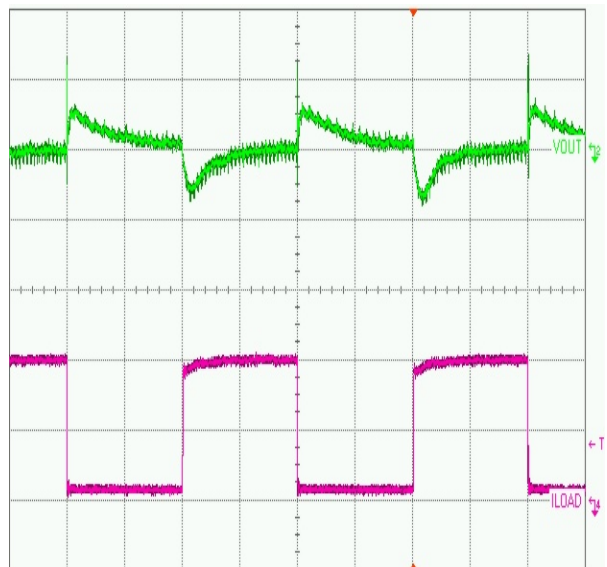

($V_{in} = 5\text{ V}$, $L = 5\ \mu\text{H}$, $C_{OUT} = 100\ \mu\text{F}$, $\text{Freq} = 333\ \text{kHz}$)
 Upper trace: Output dynamic voltage, 100 mV/div
 Lower trace: Output current, 1 A/div
 Time base : 50 $\mu\text{s}/\text{div}$

Figure 24. Load Transient Response for $V_{out} = 3.3\text{ V}$

DETAILED OPERATING DESCRIPTION

General

The NCP5252 is a PWM regulator intended for DC–DC conversion from 5 V & 12 V buses and supplies up to a 2 A load. The NCP5252 is a step down synchronous–rectifier buck topology regulator with integrated high–side and a low–side NMOS switches. The output voltage of the converter can be precisely regulated down to 600 mV \pm 1.0% when the V_{FB} pin is tied to V_{OUT} . The switching frequency can be adjusted to 333 kHz, 500 kHz, or 1 MHz. A skip mode can be enabled to provide light load efficiency.

The NCP5252 includes the following features: power good monitor, internal soft–start, cycle–by–cycle current limit, short circuit protection, output undervoltage/overvoltage protection, and thermal shutdown.

Control Logic

During start–up the internal LDO is activated and power–on reset occurs which resets the logic and all protection faults. The device will begin its start up sequence and the functionality will be determined by the voltage at the EN/SKIP pin. When voltage of EN/SKIP is below $V_{EN_DISABLE}$, the converter will shut down. If the voltage of EN/SKIP is set between V_{EN_FPWM} and V_{EN_SKIP} , the device will be in PWM mode of operation. When the voltage level of EN/SKIP is above V_{EN_SKIP} , the device will operate in PFM power saving mode. Once V_{REF} reaches its regulation voltage, an internal signal will wake up the output undervoltage supply monitor which will assert a “GOOD” condition. In addition, the NCP5252 continuously monitors the V_{CC} level with an undervoltage lockout (UVLO) function.

Forced PWM Operation (FPWM Mode)

To place the device into force PWM mode, the EN/SKIP pin voltage should be set between V_{EN_FPWM} and V_{EN_SKIP} thresholds. During the soft–start operation, the NCP5252 will automatically run as FPWM mode until the output voltage is higher than the internal soft–start ramp.

In FPWM mode in each switching cycle, the high–side MOSFET turns on for a time period defined by the ratio of input voltage to output voltage known as duty ratio. After a short period of time following high–side MOSFET turn off, the low–side MOSFET turns on and remains on for the remainder of the switching cycle. At currents below the critical conduction point, the low–side MOSFET will sync current out of the output capacitor, reducing overall converter efficiency at light loads.

Pulse Skipping Operation (Skip Mode/PFM)

The device operates in skip mode if the EN/SKIP pin voltage is greater than 2.9 V. Skip mode can reduce the switching loss in light load conditions.

When the converter inductor current is greater than the critical conduction point, the converter will run in continuous–conduction–mode (CCM) which behaves exactly the same as FPWM mode. When the inductor current

crosses zero from positive to negative, the low–side MOSFET is shut off so that current is not pulled out of the output capacitor. A high–side MOSFET turn on is not initiated until the COMP voltage exceeds the bottom of the PWM ramp.

Transient Response Enhancement (TRE)

To improve transient response in CCM, a transient response enhancement circuitry is implemented inside the NCP5252.

In CCM operation, the controller continuously monitors the COMP pin voltage of the error amplifier and detects load transient events. The functional block diagram of TRE is shown as follows:

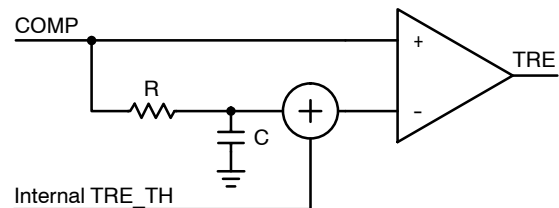

Figure 25. Block Diagram of TRE Circuit

If a large transient occurs, the COMP signal will exceed the comparator threshold indicating that a transient has occurred and action is required. When the comparator trips an extra high–side pulse is generated and the converter appears to run at a higher frequency. Once the transient has passed, the converter returns to normal operation and normal switching frequency.

Voltage Feed Forward

The NCP5252 has a voltage feed forward derived ramp. Voltage feed–forward is employed to ease loop compensation for wide–input–range designs and provide better line transient response. The ramp generator provides voltage feed–forward control by varying the PWM ramp slope with line voltage. One important thing to note is that since the slope changes with the input voltage, the ramp height will also change, resulting in an almost constant gain over input voltages. Varying the PWM ramp directly with line voltage provides excellent response to line variations, because the PWM is not required to wait for loop delays before changing the duty cycle.

The peak to peak ramp voltage can be calculated using the following equation:

$$V_{RAMP_PP} = 0.25 \cdot V_{IN}$$

Overcurrent Protection (OCP)

The NCP5252 will protect the system if an overcurrent event occurs. The regulator will continuously monitor the output current through the internal MOSFETs. If the high–side MOSFET current exceeds the internal current limit threshold, it will be turned off. If a repetitive overcurrent event occurs, both MOSFETs will be turned off and the device will hold for 3 normal soft–start periods

NCP5252

before re-starting. A discharge resistor is turned on to discharge V_o before re-starting.

Overvoltage Protection (OVP)

When the SMPS output voltage is above 115% (typ) of the preset nominal regulation voltage for over 1.5 μ s, an OV fault is set. The high-side MOSFET will turn off and the low-side MOSFET will be turned on to discharge the output until V_o drops below the default threshold (105%). Once the output voltage is below the overvoltage window, the device will recover to normal operation.

Undervoltage Protection (UVP)

A UVP circuit monitors the output voltage to detect an undervoltage event. The undervoltage limit is 80% (typ) of the nominal output voltage level. If the output voltage is below this threshold for over 4 switching cycles, a UVP fault is set. The high-side and low-side MOSFETs are turned off and a discharge resistor is turned on to discharge the output

voltage for 3 soft-start periods. Once the 3 soft-start periods have ended, the regulator will go through a normal soft-start cycle.

LDO Regulator

The internal LDO regulator (V5) can provide up to 20 mA (typ) for internal analog circuitry. Connect a capacitor to pin V5 for proper regulation.

Undervoltage Logout

The UVLO circuit will activate when the V_{CC} voltage is below 3.5 V (typ). At that time both MOSFETs will turn off. When the V_{CC} voltage is higher than 4.0 V, the UVLO flag will be cleared and the soft-start function will activate.

Thermal Shutdown

The IC will shutdown if the die temperature exceeds 150°C. The IC will restart with soft-start operation only after the junction temperature drops below 125°C.

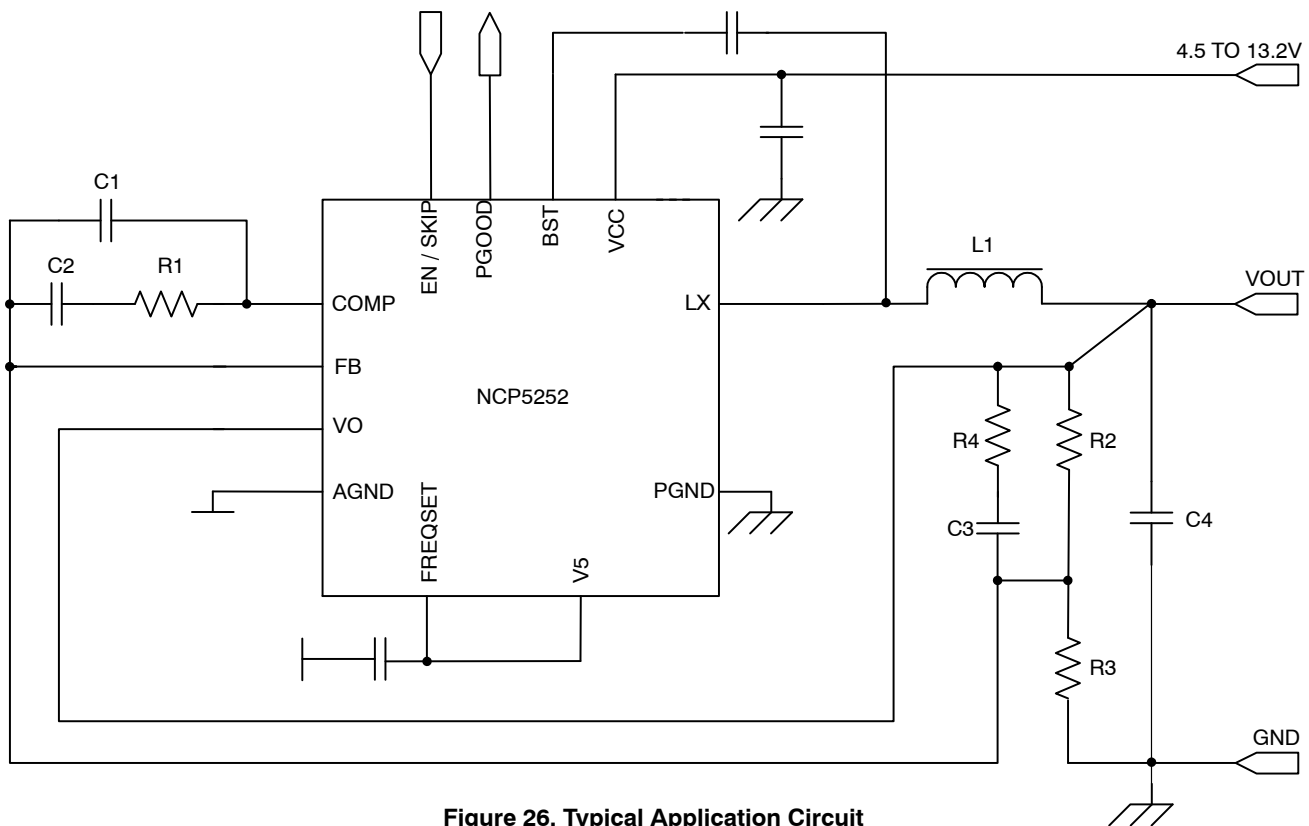

Figure 26. Typical Application Circuit

NCP5252

Table 1. Typical Design Value

For Vcc = 12 V Application											
Vin (V)	Vout (V)	Fsw (kHz)	C1 (pF)	C2 (nF)	R1 (kΩ)	R2 (kΩ)	R3 (kΩ)	R4 (Ω)	C3 (pF)	C4 (μF)	L1 (μH)
12	5	Any	10	2.0	23	10	1.4	200	800	Ceramic 22 μF x 2	5.0
12	3.3	Any	10	2.0	23	10	2.2	200	800	Ceramic 22 μF x 2	5.0
12	1.2	Any	10	2.0	23	10	10	200	800	Ceramic 22 μF x 2	5.0
12	5	Any	10	2.0	54	10	1.4	200	800	SP 100 μF / 12 mΩ	5.0
12	3.3	Any	10	2.0	54	10	2.2	200	800	SP 100 μF / 12 mΩ	5.0
12	1.2	Any	10	2.0	54	10	10	200	800	SP 100 μF / 12 mΩ	5.0
12	5	Any	10	1.0	30	10	1.4	NC	NC	Electrolytic 470 μF/160 mΩ	5.0
12	3.3	Any	10	1.0	30	10	2.2	NC	NC	Electrolytic 470 μF/160 mΩ	5.0
12	1.2	Any	10	1.0	30	10	10	NC	NC	Electrolytic 470 μF/160 mΩ	5.0
For Vcc = 5 V Application											
Vin (V)	Vout (V)	Fsw (kHz)	C1 (pF)	C2 (nF)	R1 (kΩ)	R2 (kΩ)	R3 (kΩ)	R4 (Ω)	C3 (pF)	C4 (μF)	L1 (μH)
5	3.3	Any	10	2.0	56	10	2.2	200	800	Ceramic 22 μF x 2, ESR = 4 mΩ	5.0
5	1.2	Any	10	2.0	56	10	10	200	800	Ceramic 22 μF x 2, ESR = 4 mΩ	5.0
5	3.3	Any	10	2.0	100	10	2.2	200	800	SP 100 μF / ESR = 12 mΩ	5.0
5	1.2	Any	10	2.0	100	10	10	200	800	SP 100 μF / ESR = 12 mΩ	5.0
5	3.3	Any	10	1.0	60	10	2.2	NC	NC	Electrolytic 470 μF/ESR = 160 mΩ	5.0
5	1.2	Any	10	1.0	60	10	10	NC	NC	Electrolytic 470 μF/ESR = 160 mΩ	5.0

NCP5252

TIMING DIAGRAMS

Timing 1 (SMPS Enable and Disable by EN_SKIP)

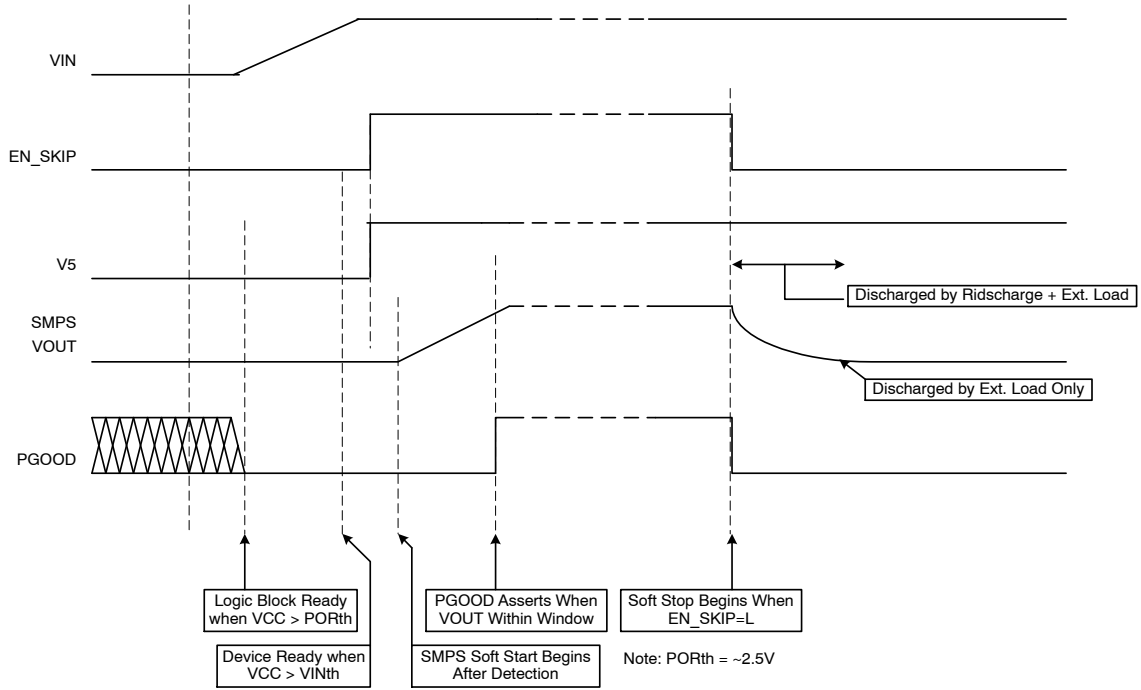

Figure 27.

Timing 2 (SMPS OVP & UVP Operation)

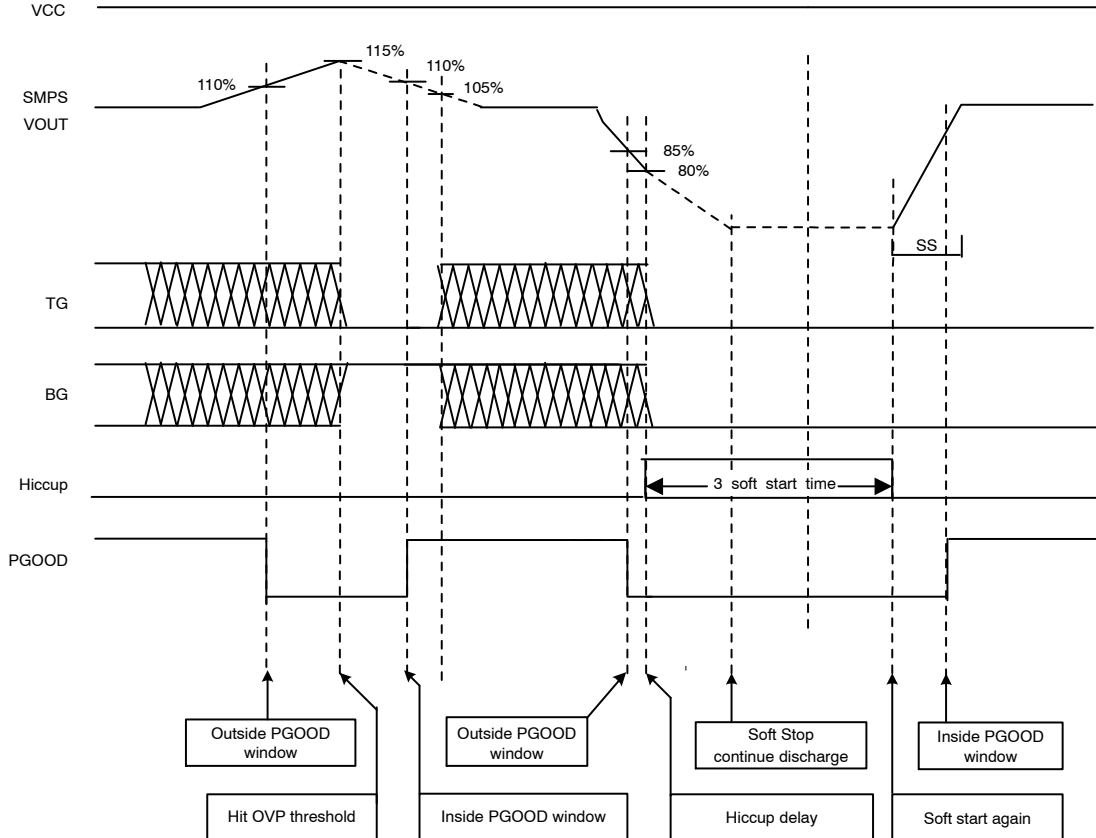
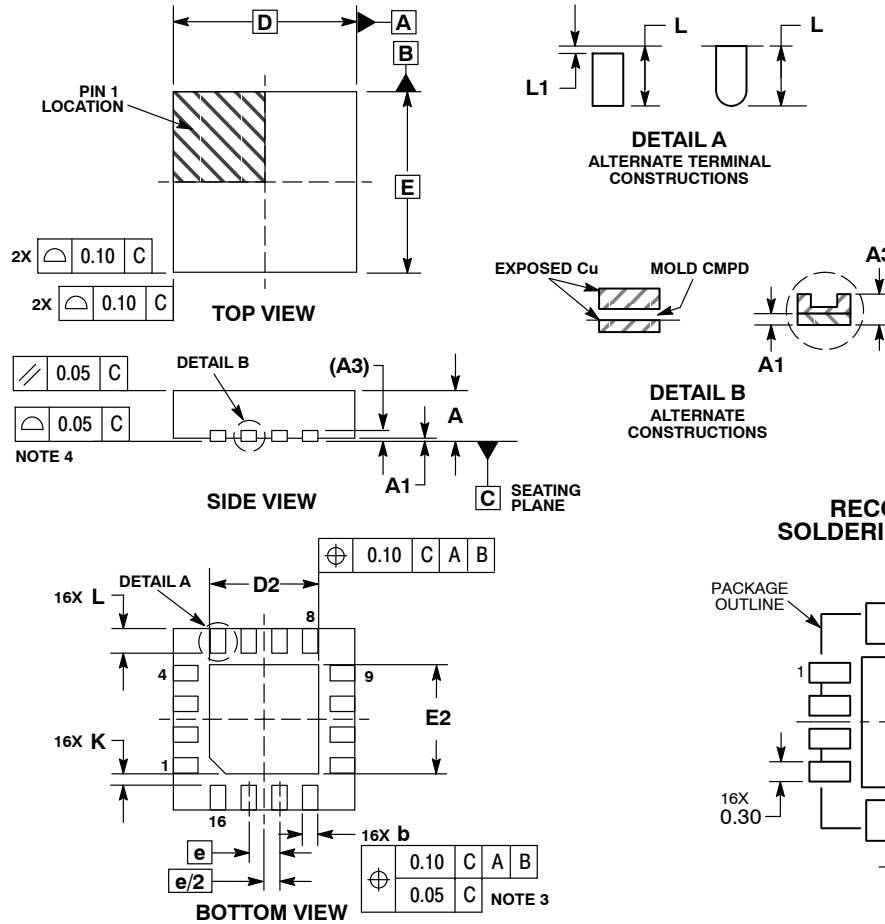

Figure 28.

NCP5252

PACKAGE DIMENSIONS

QFN16, 3x3, 0.5P
CASE 485G
ISSUE F



NOTES:

1. DIMENSIONING AND TOLERANCING PER ASME Y14.5M, 1994.
2. CONTROLLING DIMENSION: MILLIMETERS.
3. DIMENSION b APPLIES TO PLATED TERMINAL AND IS MEASURED BETWEEN 0.25 AND 0.30 MM FROM TERMINAL.
4. COPLANARITY APPLIES TO THE EXPOSED PAD AS WELL AS THE TERMINALS.

*For additional information on our Pb-Free strategy and soldering details, please download the ON Semiconductor Soldering and Mounting Techniques Reference Manual, SOLDERRM/D.

ON Semiconductor and are registered trademarks of Semiconductor Components Industries, LLC (SCILLC). SCILLC owns the rights to a number of patents, trademarks, copyrights, trade secrets, and other intellectual property. A listing of SCILLC's product/patent coverage may be accessed at www.onsemi.com/site/pdf/Patent-Marking.pdf. SCILLC reserves the right to make changes without further notice to any products herein. SCILLC makes no warranty, representation or guarantee regarding the suitability of its products for any particular purpose, nor does SCILLC assume any liability arising out of the application or use of any product or circuit, and specifically disclaims any and all liability, including without limitation special, consequential or incidental damages. "Typical" parameters which may be provided in SCILLC data sheets and/or specifications can and do vary in different applications and actual performance may vary over time. All operating parameters, including "Typicals" must be validated for each customer application by customer's technical experts. SCILLC does not convey any license under its patent rights nor the rights of others. SCILLC products are not designed, intended, or authorized for use as components in systems intended for surgical implant into the body, or other applications intended to support or sustain life, or for any other application in which the failure of the SCILLC product could create a situation where personal injury or death may occur. Should Buyer purchase or use SCILLC products for any such unintended or unauthorized application, Buyer shall indemnify and hold SCILLC and its officers, employees, subsidiaries, affiliates, and distributors harmless against all claims, costs, damages, and expenses, and reasonable attorney fees arising out of, directly or indirectly, any claim of personal injury or death associated with such unintended or unauthorized use, even if such claim alleges that SCILLC was negligent regarding the design or manufacture of the part. SCILLC is an Equal Opportunity/Affirmative Action Employer. This literature is subject to all applicable copyright laws and is not for resale in any manner.

PUBLICATION ORDERING INFORMATION

LITERATURE FULFILLMENT:
Literature Distribution Center for ON Semiconductor
P.O. Box 5163, Denver, Colorado 80217 USA
Phone: 303-675-2175 or 800-344-3860 Toll Free USA/Canada
Fax: 303-675-2176 or 800-344-3867 Toll Free USA/Canada
Email: orderlit@onsemi.com

N. American Technical Support: 800-282-9855 Toll Free
USA/Canada
Europe, Middle East and Africa Technical Support:
Phone: 421 33 790 2910
Japan Customer Focus Center
Phone: 81-3-5817-1050

ON Semiconductor Website: www.onsemi.com
Order Literature: <http://www.onsemi.com/orderlit>
For additional information, please contact your local Sales Representative