

BUB323Z

NPN Silicon Power Darlington High Voltage Autoprotected D²PAK for Surface Mount

The BUB323Z is a planar, monolithic, high-voltage power Darlington with a built-in active zener clamping circuit. This device is specifically designed for unclamped, inductive applications such as Electronic Ignition, Switching Regulators and Motor Control.

Features

- Integrated High-Voltage Active Clamp
- Tight Clamping Voltage Window (350 V to 450 V) Guaranteed Over the -40°C to +125°C Temperature Range
- Clamping Energy Capability 100% Tested in a Live Ignition Circuit
- High DC Current Gain/Low Saturation Voltages Specified Over Full Temperature Range
- Design Guarantees Operation in SOA at All Times
- NJV Prefix for Automotive and Other Applications Requiring Unique Site and Control Change Requirements; AEC-Q101 Qualified and PPAP Capable
- These Devices are Pb-Free, Halogen Free/BFR Free and are RoHS Compliant

MAXIMUM RATINGS

Rating	Symbol	Value	Unit
Collector-Emitter Sustaining Voltage	V_{CEO}	350	Vdc
Collector-Emitter Voltage	V_{EBO}	6.0	Vdc
Collector Current – Continuous – Peak	I_C I_{CM}	10 20	Adc
Base Current – Continuous – Peak	I_B I_{BM}	3.0 6.0	Adc
Total Power Dissipation @ $T_C = 25^\circ\text{C}$ Derate above 25°C	P_D	150 1.0	W W/°C
Operating and Storage Junction Temperature Range	T_J, T_{stg}	-65 to +175	°C

THERMAL CHARACTERISTICS

Characteristic	Symbol	Max	Unit
Thermal Resistance, Junction-to-Case	$R_{\theta JC}$	1.0	°C/W
Thermal Resistance, Junction-to-Ambient	$R_{\theta JA}$	62.5	°C/W
Maximum Lead Temperature for Soldering Purposes, 1/8 in from Case for 5 Seconds	T_L	260	°C

Stresses exceeding those listed in the Maximum Ratings table may damage the device. If any of these limits are exceeded, device functionality should not be assumed, damage may occur and reliability may be affected.



ON Semiconductor®

<http://onsemi.com>

**AUTOPROTECTED
DARLINGTON
10 AMPERES
360-450 VOLTS CLAMP
150 WATTS**

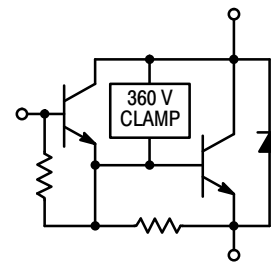

MARKING DIAGRAM

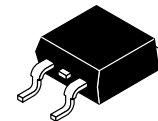

**D²PAK
CASE 418B
STYLE 1**

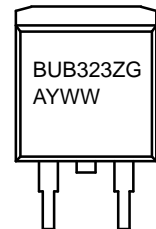

BUB323Z = Specific Device Code
A = Assembly Location
Y = Year
WW = Work Week
G = Pb-Free Package

ORDERING INFORMATION

See detailed ordering and shipping information in the package dimensions section on page 6 of this data sheet.

BUB323Z

ELECTRICAL CHARACTERISTICS (T_C = 25°C unless otherwise noted)

Characteristic	Symbol	Min	Typ	Max	Unit
----------------	--------	-----	-----	-----	------

OFF CHARACTERISTICS (Note 1)

Collector–Emitter Clamping Voltage (I _C = 7.0 A) (T _C = –40°C to +125°C)	V _{CLAMP}	350	–	450	Vdc
Collector–Emitter Cutoff Current (V _{CE} = 200 V, I _B = 0)	I _{CEO}	–	–	100	μAdc
Emitter–Base Leakage Current (V _{EB} = 6.0 Vdc, I _C = 0)	I _{EBO}	–	–	50	mAdc

ON CHARACTERISTICS (Note 1)

Base–Emitter Saturation Voltage (I _C = 8.0 Adc, I _B = 100 mAdc) (I _C = 10 Adc, I _B = 0.25 Adc)	V _{BE(sat)}	– –	– –	2.2 2.5	Vdc
Collector–Emitter Saturation Voltage (I _C = 7.0 Adc, I _B = 70 mAdc) (I _C = 8.0 Adc, I _B = 0.1 Adc) (I _C = 10 Adc, I _B = 0.25 Adc)	V _{CE(sat)}	– – –	– – –	1.6 1.8 1.8 2.1 1.7	Vdc
Base–Emitter On Voltage (I _C = 5.0 Adc, V _{CE} = 2.0 Vdc) (I _C = 8.0 Adc, V _{CE} = 2.0 Vdc)	V _{BE(on)}	1.1 1.3	– –	2.1 2.3	Vdc
Diode Forward Voltage Drop (I _F = 10 Adc)	V _F	–	–	2.5	Vdc
DC Current Gain (I _C = 6.5 Adc, V _{CE} = 1.5 Vdc) (I _C = 5.0 Adc, V _{CE} = 4.6 Vdc)	h _{FE}	150 500	– –	– 3400	–

DYNAMIC CHARACTERISTICS

Current Gain Bandwidth (I _C = 0.2 Adc, V _{CE} = 10 Vdc, f = 1.0 MHz)	f _T	–	–	2.0	MHz
Output Capacitance (V _{CB} = 10 Vdc, I _E = 0, f = 1.0 MHz)	C _{ob}	–	–	200	pF
Input Capacitance (V _{EB} = 6.0 V)	C _{ib}	–	–	550	pF

CLAMPING ENERGY (See Notes)

Repetitive Non–Destructive Energy Dissipated at turn–off: (I _C = 7.0 A, L = 8.0 mH, R _{BE} = 100 Ω) (see Figures 2 and 4)	W _{CLAMP}	200	–	–	mJ
--	--------------------	-----	---	---	----

SWITCHING CHARACTERISTICS: Inductive Load (L = 10 mH)

Fall Time	(I _C = 6.5 A, I _{B1} = 45 mA, V _{BE(off)} = 0, R _{BE(off)} = 0, V _{CC} = 14 V, V _Z = 300 V)	t _{fi}	–	625	–	ns
Storage Time		t _{si}	–	10	30	μs
Cross–over Time		t _c	–	1.7	–	μs

Product parametric performance is indicated in the Electrical Characteristics for the listed test conditions, unless otherwise noted. Product performance may not be indicated by the Electrical Characteristics if operated under different conditions.

1. Pulse Test: Pulse Width ≤ 300 μs, Duty Cycle = 2.0%.

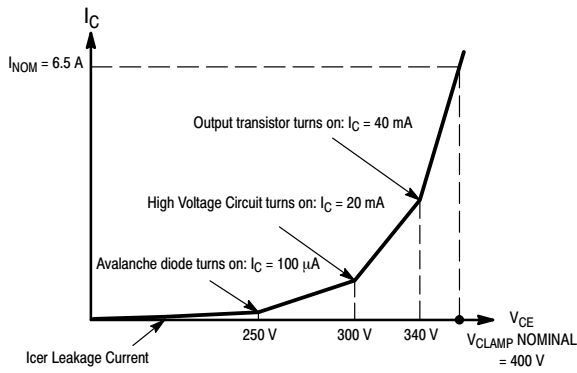

Figure 1. $I_C = f(V_{CE})$ Curve Shape

By design, the BU323Z has a built-in avalanche diode and a special high voltage driving circuit. During an auto-protect cycle, the transistor is turned on again as soon as a voltage, determined by the zener threshold and the network, is reached. This prevents the transistor from going into a Reverse Bias Operating limit condition. Therefore, the device will have an extended safe operating area and will always appear to be in “FBSOA.” Because of the built-in zener and associated network, the $I_C = f(V_{CE})$ curve exhibits an unfamiliar shape compared to standard products as shown in Figure 1.

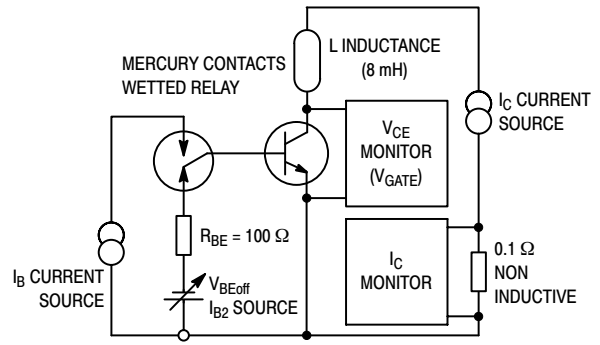

Figure 2. Basic Energy Test Circuit

The bias parameters, V_{CLAMP} , I_{B1} , $V_{BE(off)}$, I_{B2} , I_C , and the inductance, are applied according to the Device Under Test (DUT) specifications. V_{CE} and I_C are monitored by the test system while making sure the load line remains within the limits as described in Figure 4.

Note: All BU323Z ignition devices are 100% energy tested, per the test circuit and criteria described in Figures 2 and 4, to the minimum guaranteed repetitive energy, as specified in the device parameter section. The device can sustain this energy on a repetitive basis without degrading any of the specified electrical characteristics of the devices. The units under test are kept functional during the complete test sequence for the test conditions described:

$I_{C(peak)} = 7.0 \text{ A}$, $I_{CH} = 5.0 \text{ A}$, $I_{CL} = 100 \text{ mA}$, $I_B = 100 \text{ mA}$, $R_{BE} = 100 \text{ } \Omega$, $V_{gate} = 280 \text{ V}$, $L = 8.0 \text{ mH}$

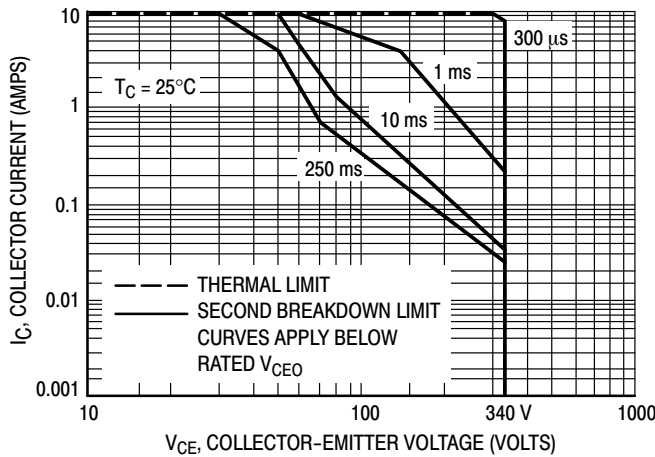
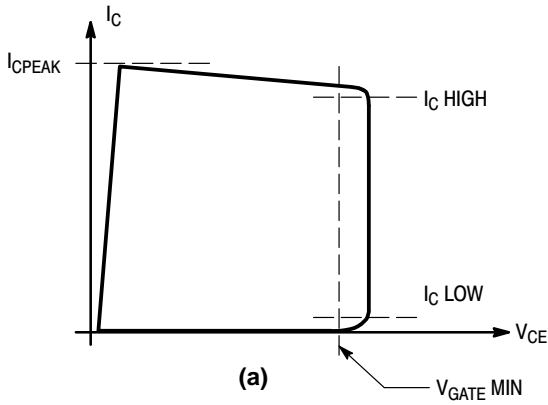
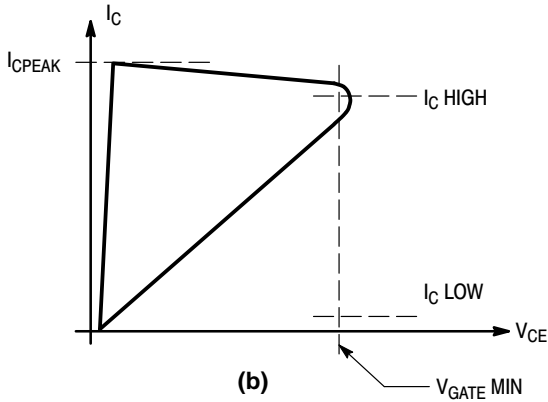

Figure 3. Forward Bias Safe Operating Area



The shaded area represents the amount of energy the device can sustain, under given DC biases ($I_C/I_B/V_{BE(off)}/R_{BE}$), without an external clamp; see the test schematic diagram, Figure 2.

The transistor **PASSES** the Energy test if, for the inductive load and $I_{CPEAK}/I_B/V_{BE(off)}$ biases, the V_{CE} remains outside the shaded area and greater than the V_{GATE} minimum limit, Figure 4a.



The transistor **FAILS** if the V_{CE} is less than the V_{GATE} (minimum limit) at any point along the V_{CE}/I_C curve as shown on Figures 4b, and 4c. This assures that hot spots and uncontrolled avalanche are not being generated in the die, and the transistor is not damaged, thus enabling the sustained energy level required.

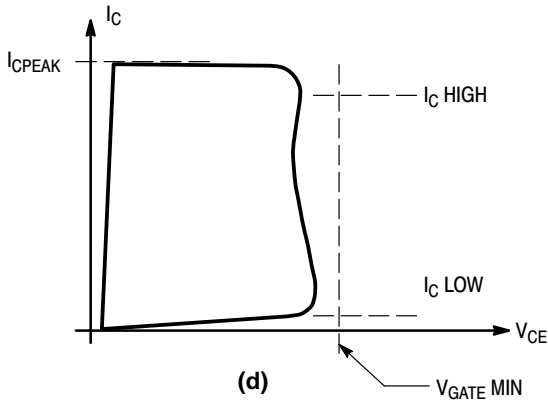
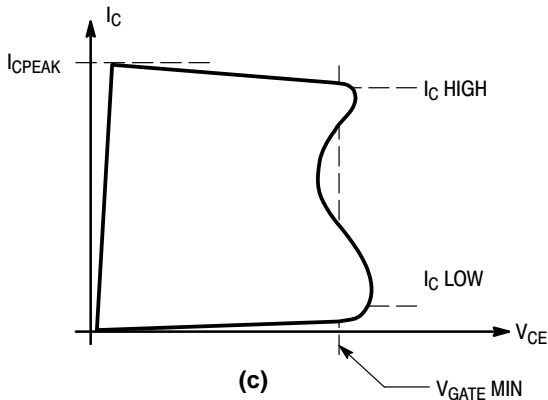

The transistor **FAILS** if its Collector/Emitter breakdown voltage is less than the V_{GATE} value, Figure 4d.

Figure 4. Energy Test Criteria for BU323Z

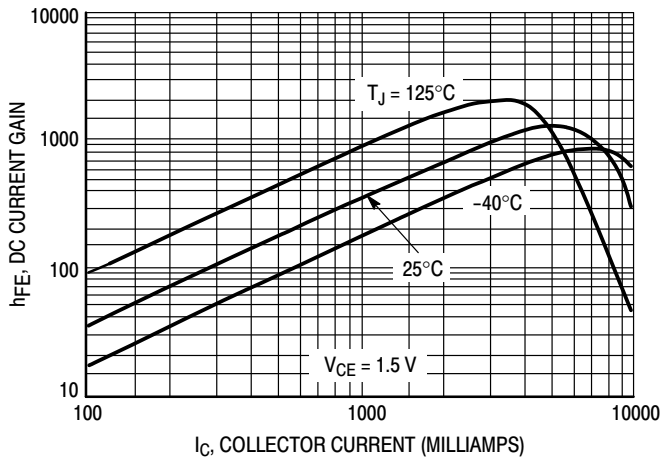

Figure 5. DC Current Gain

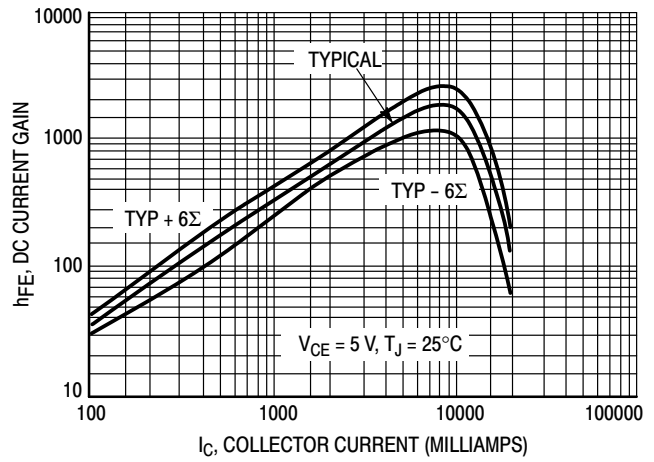

Figure 6. DC Current Gain

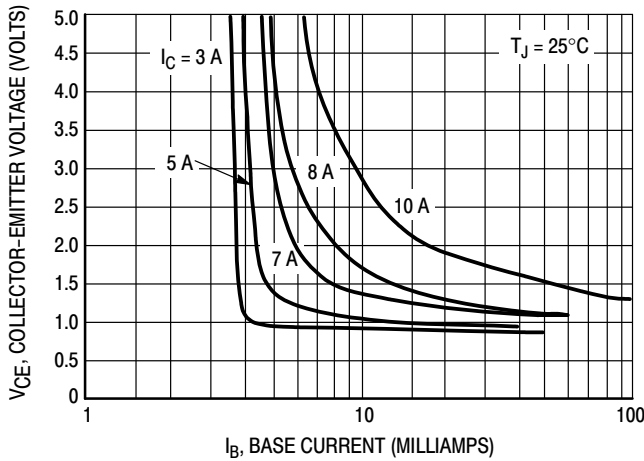

Figure 7. Collector Saturation Region

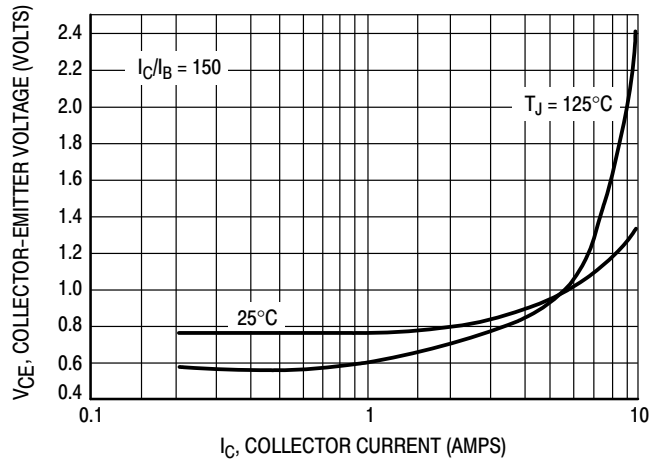

Figure 8. Collector-Emitter Saturation Voltage

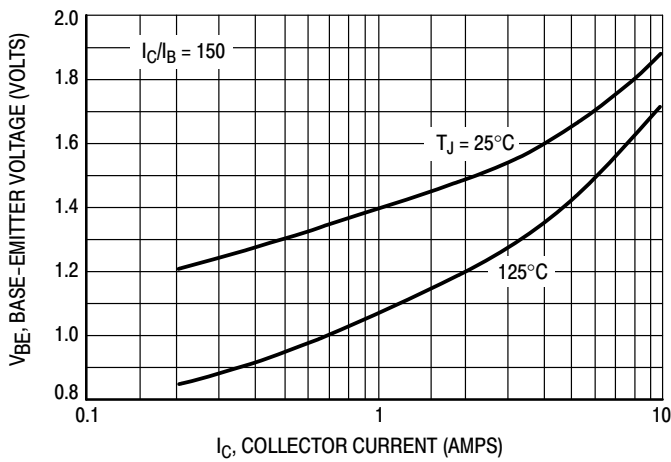

Figure 9. Base-Emitter Saturation Voltage

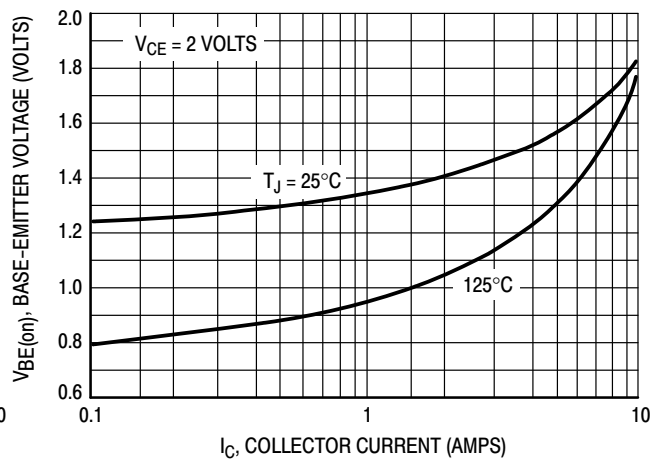

Figure 10. Base-Emitter "ON" Voltages

BUB323Z

ORDERING INFORMATION

Device	Package	Shipping†
BUB323ZG	D ² PAK (Pb-Free)	50 Units / Rail
BUB323ZT4G	D ² PAK (Pb-Free)	800 Units / Tape & Reel
NJVBUB323ZT4G*	D ² PAK (Pb-Free)	800 Units / Tape & Reel

†For information on tape and reel specifications, including part orientation and tape sizes, please refer to our Tape and Reel Packaging Specifications Brochure, BRD8011/D.

*NJV Prefix for Automotive and Other Applications Requiring Unique Site and Control Change Requirements; AEC-Q101 Qualified and PPAP Capable.

MECHANICAL CASE OUTLINE

PACKAGE DIMENSIONS

ON Semiconductor®

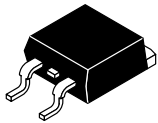

D²PAK 3
CASE 418B-04
ISSUE L

DATE 17 FEB 2015

SCALE 1:1

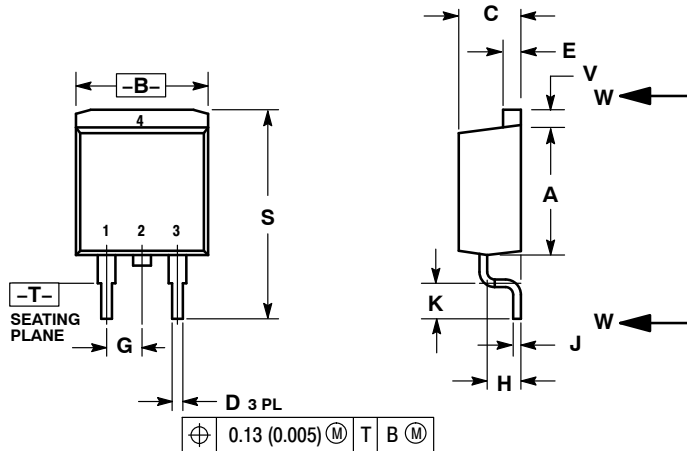

NOTES:

- DIMENSIONING AND TOLERANCING PER ANSI Y14.5M, 1982.
- CONTROLLING DIMENSION: INCH.
- 418B-01 THRU 418B-03 OBSOLETE, NEW STANDARD 418B-04.

DIM	INCHES		MILLIMETERS	
	MIN	MAX	MIN	MAX
A	0.340	0.380	8.64	9.65
B	0.380	0.405	9.65	10.29
C	0.160	0.190	4.06	4.83
D	0.020	0.035	0.51	0.89
E	0.045	0.055	1.14	1.40
F	0.310	0.350	7.87	8.89
G	0.100	BSC	2.54	BSC
H	0.080	0.110	2.03	2.79
J	0.018	0.025	0.46	0.64
K	0.090	0.110	2.29	2.79
L	0.052	0.072	1.32	1.83
M	0.280	0.320	7.11	8.13
N	0.197	REF	5.00	REF
P	0.079	REF	2.00	REF
R	0.039	REF	0.99	REF
S	0.575	0.625	14.60	15.88
V	0.045	0.055	1.14	1.40

VARIABLE CONFIGURATION ZONE

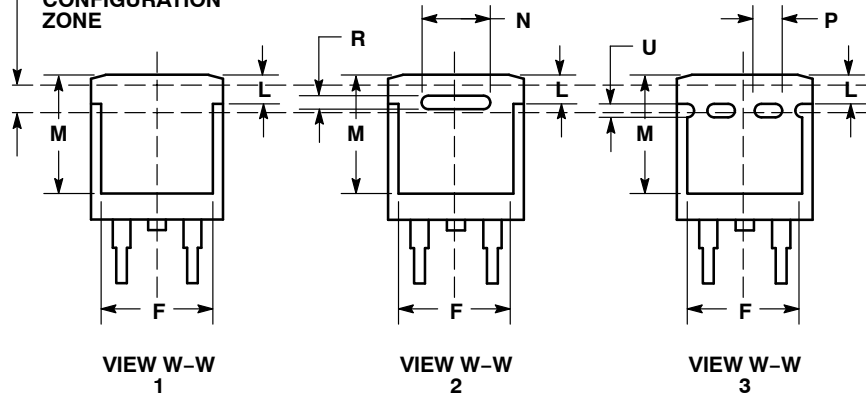

- | | | | | | |
|--|---|---|--|---|--|
| STYLE 1:
PIN 1. BASE
2. COLLECTOR
3. EMITTER
4. COLLECTOR | STYLE 2:
PIN 1. GATE
2. DRAIN
3. SOURCE
4. DRAIN | STYLE 3:
PIN 1. ANODE
2. CATHODE
3. ANODE
4. CATHODE | STYLE 4:
PIN 1. GATE
2. COLLECTOR
3. EMITTER
4. COLLECTOR | STYLE 5:
PIN 1. CATHODE
2. ANODE
3. CATHODE
4. ANODE | STYLE 6:
PIN 1. NO CONNECT
2. CATHODE
3. ANODE
4. CATHODE |
|--|---|---|--|---|--|

MARKING INFORMATION AND FOOTPRINT ON PAGE 2

DOCUMENT NUMBER:	98ASB42761B	Electronic versions are uncontrolled except when accessed directly from the Document Repository. Printed versions are uncontrolled except when stamped "CONTROLLED COPY" in red.
DESCRIPTION:	D²PAK 3	PAGE 1 OF 2

ON Semiconductor and ON are trademarks of Semiconductor Components Industries, LLC dba ON Semiconductor or its subsidiaries in the United States and/or other countries. ON Semiconductor reserves the right to make changes without further notice to any products herein. ON Semiconductor makes no warranty, representation or guarantee regarding the suitability of its products for any particular purpose, nor does ON Semiconductor assume any liability arising out of the application or use of any product or circuit, and specifically disclaims any and all liability, including without limitation special, consequential or incidental damages. ON Semiconductor does not convey any license under its patent rights nor the rights of others.

D²PAK 3
CASE 418B-04
ISSUE L

DATE 17 FEB 2015

**GENERIC
MARKING DIAGRAM***

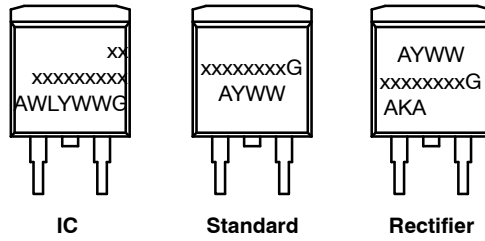

- xx = Specific Device Code
- A = Assembly Location
- WL = Wafer Lot
- Y = Year
- WW = Work Week
- G = Pb-Free Package
- AKA = Polarity Indicator

*This information is generic. Please refer to device data sheet for actual part marking. Pb-Free indicator, "G" or microdot "▪", may or may not be present.

SOLDERING FOOTPRINT*

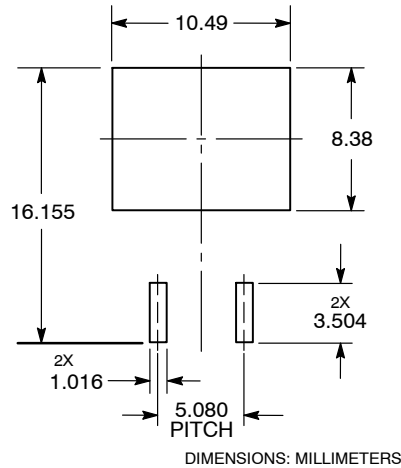

*For additional information on our Pb-Free strategy and soldering details, please download the ON Semiconductor Soldering and Mounting Techniques Reference Manual, SOLDERRM/D.

DOCUMENT NUMBER:	98ASB42761B	Electronic versions are uncontrolled except when accessed directly from the Document Repository. Printed versions are uncontrolled except when stamped "CONTROLLED COPY" in red.
DESCRIPTION:	D²PAK 3	PAGE 2 OF 2

ON Semiconductor and are trademarks of Semiconductor Components Industries, LLC dba ON Semiconductor or its subsidiaries in the United States and/or other countries. ON Semiconductor reserves the right to make changes without further notice to any products herein. ON Semiconductor makes no warranty, representation or guarantee regarding the suitability of its products for any particular purpose, nor does ON Semiconductor assume any liability arising out of the application or use of any product or circuit, and specifically disclaims any and all liability, including without limitation special, consequential or incidental damages. ON Semiconductor does not convey any license under its patent rights nor the rights of others.

onsemi, **Onsemi**, and other names, marks, and brands are registered and/or common law trademarks of Semiconductor Components Industries, LLC dba "**onsemi**" or its affiliates and/or subsidiaries in the United States and/or other countries. **onsemi** owns the rights to a number of patents, trademarks, copyrights, trade secrets, and other intellectual property. A listing of **onsemi**'s product/patent coverage may be accessed at www.onsemi.com/site/pdf/Patent-Marking.pdf. **onsemi** reserves the right to make changes at any time to any products or information herein, without notice. The information herein is provided "as-is" and **onsemi** makes no warranty, representation or guarantee regarding the accuracy of the information, product features, availability, functionality, or suitability of its products for any particular purpose, nor does **onsemi** assume any liability arising out of the application or use of any product or circuit, and specifically disclaims any and all liability, including without limitation special, consequential or incidental damages. Buyer is responsible for its products and applications using **onsemi** products, including compliance with all laws, regulations and safety requirements or standards, regardless of any support or applications information provided by **onsemi**. "Typical" parameters which may be provided in **onsemi** data sheets and/or specifications can and do vary in different applications and actual performance may vary over time. All operating parameters, including "Typicals" must be validated for each customer application by customer's technical experts. **onsemi** does not convey any license under any of its intellectual property rights nor the rights of others. **onsemi** products are not designed, intended, or authorized for use as a critical component in life support systems or any FDA Class 3 medical devices or medical devices with a same or similar classification in a foreign jurisdiction or any devices intended for implantation in the human body. Should Buyer purchase or use **onsemi** products for any such unintended or unauthorized application, Buyer shall indemnify and hold **onsemi** and its officers, employees, subsidiaries, affiliates, and distributors harmless against all claims, costs, damages, and expenses, and reasonable attorney fees arising out of, directly or indirectly, any claim of personal injury or death associated with such unintended or unauthorized use, even if such claim alleges that **onsemi** was negligent regarding the design or manufacture of the part. **onsemi** is an Equal Opportunity/Affirmative Action Employer. This literature is subject to all applicable copyright laws and is not for resale in any manner.

ADDITIONAL INFORMATION

TECHNICAL PUBLICATIONS:

Technical Library: www.onsemi.com/design/resources/technical-documentation
onsemi Website: www.onsemi.com

ONLINE SUPPORT: www.onsemi.com/support

For additional information, please contact your local Sales Representative at www.onsemi.com/support/sales