

CGH40180PP

180 W, RF Power GaN HEMT

Description

WolfSpeed's CGH40180PP is an unmatched, gallium nitride (GaN) high electron mobility transistor (HEMT). The CGH40180PP, operating from a 28 volt rail, offers a general purpose, broadband solution to a variety of RF and microwave applications. GaN HEMTs offer high efficiency, high gain and wide bandwidth capabilities making the CGH40180PP ideal for linear and compressed amplifier circuits. The transistor is available in a 4-lead flange package.

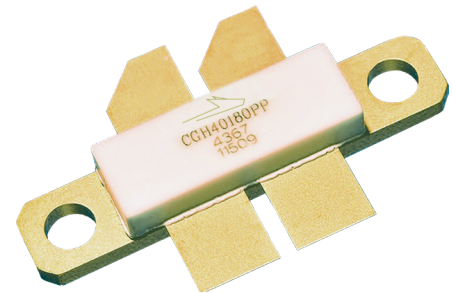

Package Types: 440199
PN: CGH40180PP

Features

- Up to 2.5 GHz Operation
- 20 dB Small Signal Gain at 1.0 GHz
- 15 dB Small Signal Gain at 2.0 GHz
- 220 W typical P_{SAT}
- 70% Efficiency at P_{SAT}
- 28 V Operation

Applications

- 2-Way Private Radio
- Broadband Amplifiers
- Cellular Infrastructure
- Test Instrumentation
- Class A, AB, Amplifiers suitable for OFDM, W-CDMA, EDGE, CDMA waveforms

 Large Signal Models Available for ADS and MWO





Absolute Maximum Ratings (not simultaneous) at 25°C Case Temperature

Parameter	Symbol	Rating	Units	Conditions
Drain-Source Voltage	V_{DSS}	120	V	25°C
Gate-to-Source Voltage	V_{GS}	-10, +2		
Storage Temperature	T_{STG}	-65, +150	°C	
Operating Junction Temperature	T_J	225		
Maximum Forward Gate Current	I_{GMAX}	60	mA	25°C
Maximum Drain Current ¹	I_{DMAX}	24	A	
Soldering Temperature ²	T_S	245	°C	
Screw Torque	τ	40	in-oz	
Thermal Resistance, Junction to Case ³	$R_{\theta JC}$	0.9	°C/W	85°C
Case Operating Temperature ^{3,4}	T_C	-40, +85	°C	

Notes:

¹ Current limit for long term, reliable operation

² Refer to the Application Note on soldering at wolfspeed.com/rf/document-library

³ CGH40180PP at $P_{DISS} = 224$ W

⁴ See also, the Power Dissipation De-rating Curve on Page 6

Electrical Characteristics ($T_C = 25^\circ\text{C}$)

Characteristics	Symbol	Min.	Typ.	Max.	Units	Conditions
DC Characteristics¹						
Gate Threshold Voltage	$V_{GS(th)}$	-3.8	-3.0	-2.3	V_{DC}	$V_{DS} = 10$ V, $I_D = 57.6$ mA
Gate Quiescent Voltage	$V_{GS(Q)}$	—	-2.7	—		$V_{DS} = 28$ V, $I_D = 2.0$ A
Saturated Drain Current ²	I_{DS}	40.3	56.4	—	A	$V_{DS} = 6.0$ V, $V_{GS} = 2.0$ V
Drain-Source Breakdown Voltage	V_{BR}	84	—	—	V_{DC}	$V_{GS} = -8$ V, $I_D = 57.6$ mA
RF Characteristics^{3,4} ($T_C = 25^\circ\text{C}$, $F_0 = 1.3$ GHz unless otherwise noted)						
Power Gain	G_P	13	—	—	dB	$V_{DD} = 28$ V, $I_{DQ} = 2.0$ A, $P_{OUT} = P_{SAT}$
Small Signal Gain	G_{SS}	—	19	—		$V_{DD} = 28$ V, $I_{DQ} = 2.0$ A
Power Output at Saturation ⁵	P_{SAT}	180	220	—	W	
Drain Efficiency ⁶	η	56	65	—	%	$V_{DD} = 28$ V, $I_{DQ} = 2.0$ A, $P_{OUT} = P_{SAT}$
Output Mismatch Stress	VSWR	—	—	10 : 1	Ψ	No damage at all phase angles, $V_{DD} = 28$ V, $I_{DQ} = 2.0$ A, $P_{OUT} = 180$ W CW
Dynamic Characteristics⁷						
Input Capacitance	C_{GS}	—	35.7	—	pF	$V_{DS} = 28$ V, $V_{GS} = -8$ V, $f = 1$ MHz
Output Capacitance	C_{DS}	—	9.6	—		
Feedback Capacitance	C_{GD}	—	1.6	—		

Notes:

¹ Measured on wafer prior to packaging

² Scaled from PCM data

³ Measured in CGH40180PP-AMP, including all coupler losses

⁴ I_{DQ} of 2.0 A is by biasing each device at 1.0 A

⁵ P_{SAT} is defined as: $Q1$ or $Q2 = I_G = 2.8$ mA

⁶ Drain Efficiency = P_{OUT}/P_{DC}

⁷ Capacitance values are for each side of the device



Typical Performance

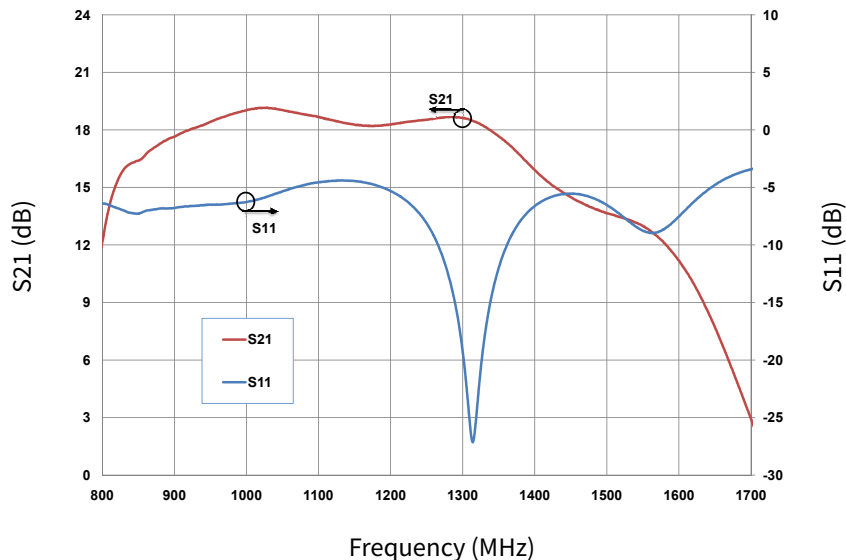

Figure 1. Gain and Return Loss vs Frequency measured in Broadband Amplifier Circuit CGH40180PP-AMP
 $V_{DD} = 28\text{ V}$, $I_{DQ} = 2.0\text{ A}$

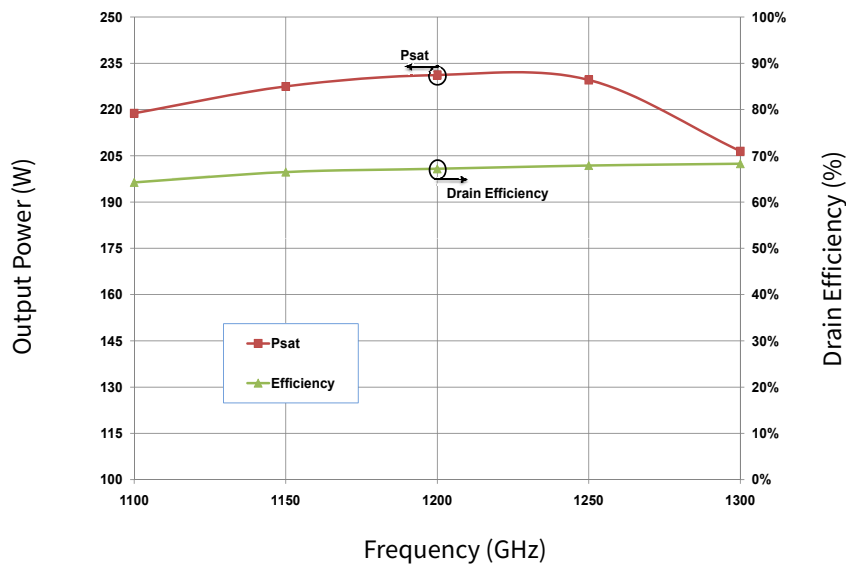

Figure 2. Output Power and Drain Efficiency vs Frequency measured in Broadband Amplifier Circuit CGH40180PP-AMP
 $V_{DD} = 28\text{ V}$, $I_{DQ} = 2.0\text{ A}$



Typical Performance

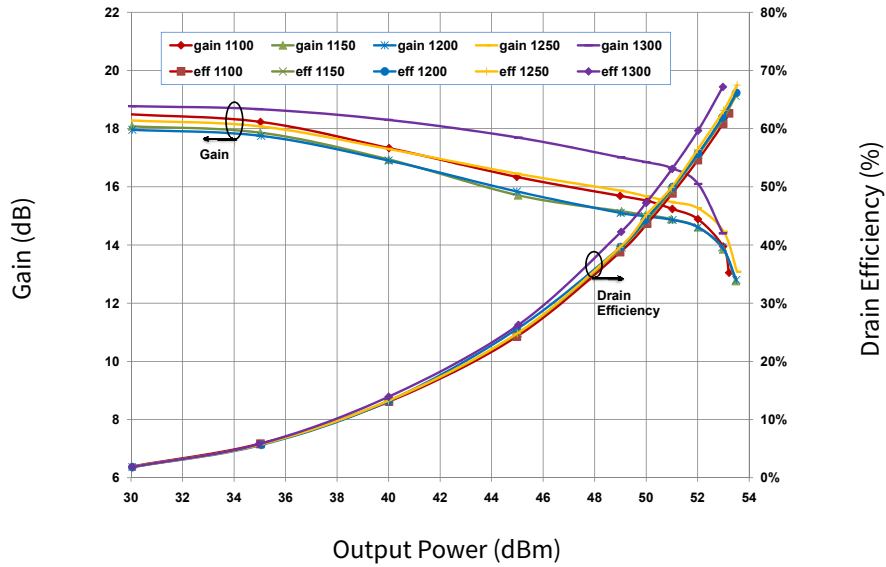

Figure 3. Gain and Drain Efficiency vs Output Power measured in Broadband Amplifier Circuit CGH40180PP-AMP
 $V_{DD} = 28\text{ V}$, $I_{DQ} = 2.0\text{ A}$

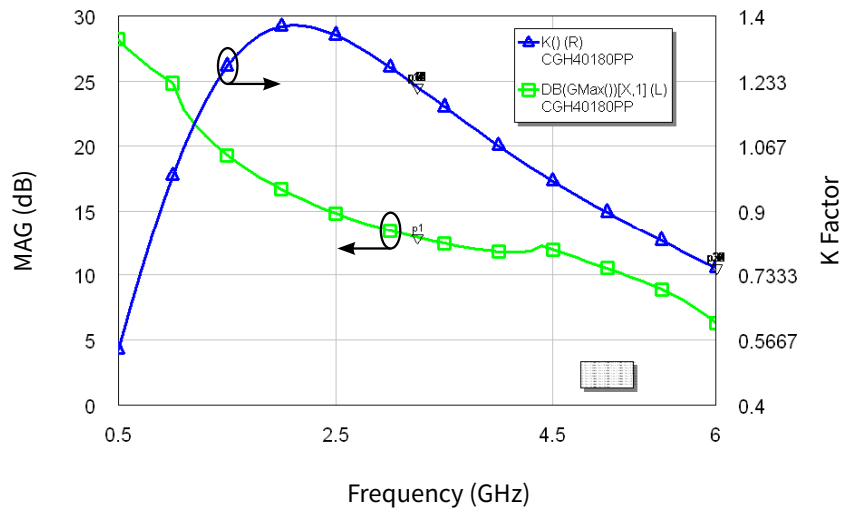

Figure 4. Simulated Maximum Available Gain and K Factor of the CGH40180PP
 $V_{DD} = 28\text{ V}$, $I_{DQ} = 1.0\text{ A}$



Typical Noise Performance

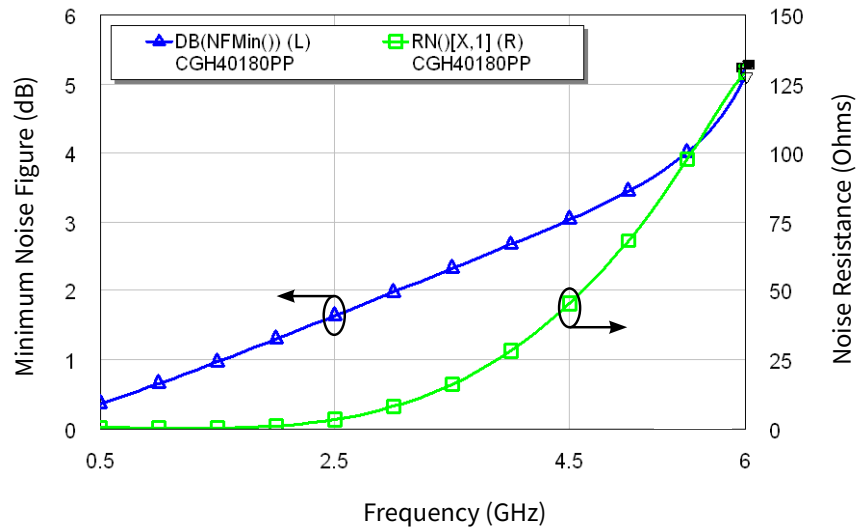
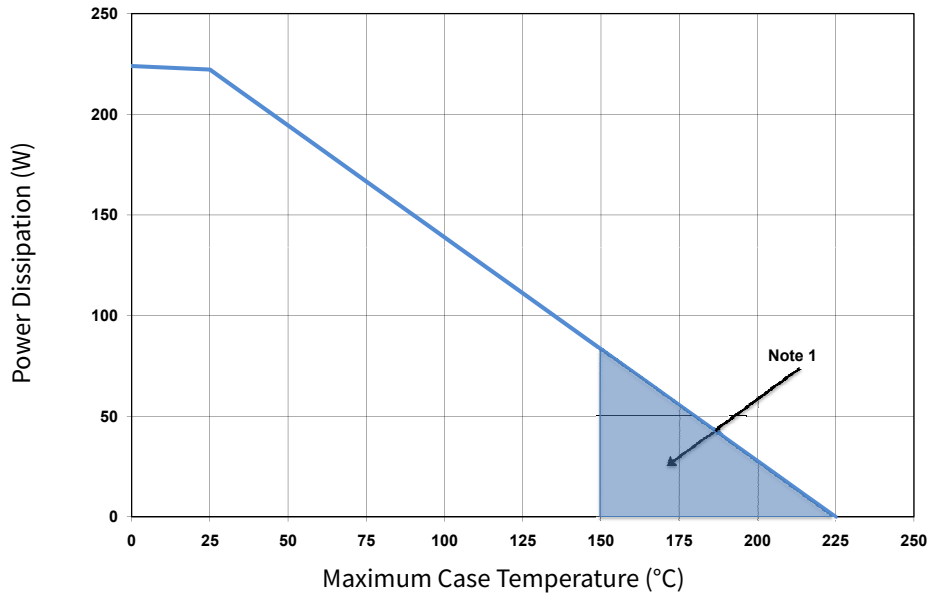

Figure 5. Simulated Minimum Noise Figure and Noise Resistance vs Frequency of the CGH40180PP
 $V_{DD} = 28\text{ V}$, $I_{DQ} = 1\text{ A}$

Electrostatic Discharge (ESD) Classifications

Parameter	Symbol	Class	Classification Level	Test Methodology
Human Body Model	HBM	1B	ANSI/ESDA/JEDEC JS-001 Table 3	JEDEC JESD22 A114-D
Charge Device Model	CDM	C3	ANSI/ESDA/JEDEC JS-002 Table 3	JEDEC JESD22 C101-C

CGH40180PP Power Dissipation De-rating Curve



Note:
¹ Area exceeds Maximum Case Operating Temperature (See Page 2)

CGH40180PP Transient Power Dissipation De-rating Curve

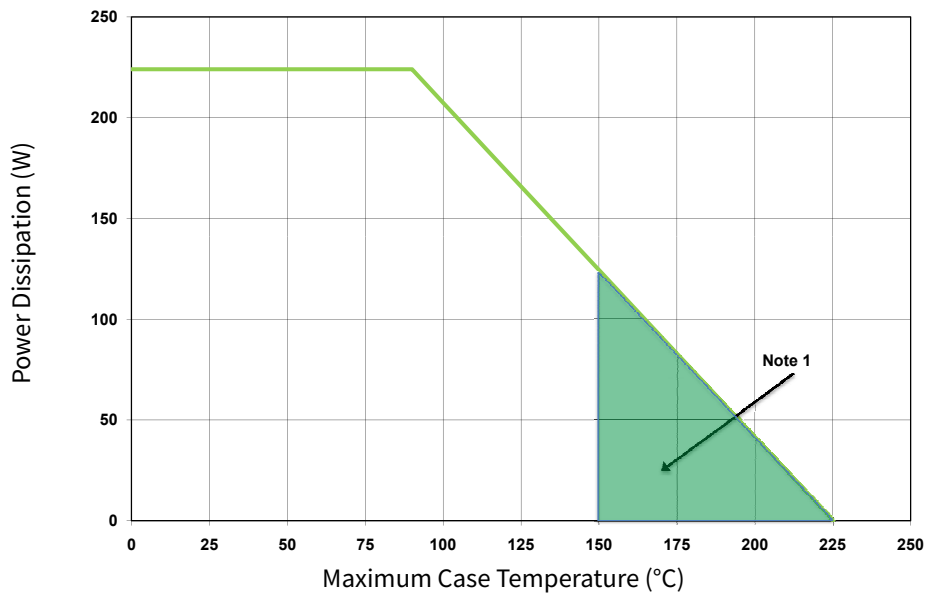

Note:
¹ Area exceeds Maximum Case Operating Temperature (See Page 2)
¹ This transient de-rating curve assumes a 1msec pulse with a 20% duty cycle with no power dissipated during the “off-cycle”

Thermal Resistance as a Function of Pulse Width

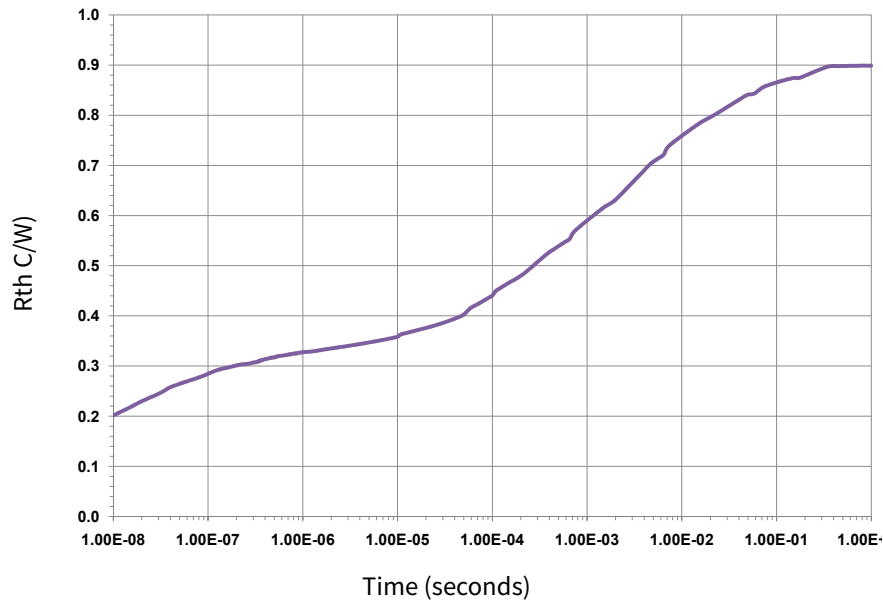

Note:

- ¹ This heating curve assumes zero power dissipation during the “off” portion of the duty cycle
- ¹ This data is for transient power dissipation at 224 W, Duty Cycle = 20%

Simulated Source and Load Impedances

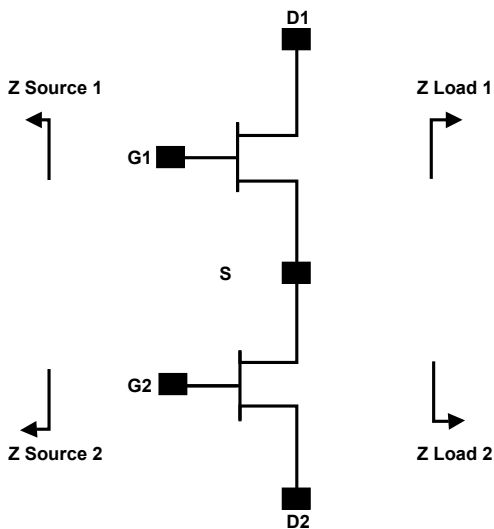

Frequency (MHz)	Z Source	Z Load
500	2.85 + j1.99	5.27 + j0.68
1000	0.8 + j0.42	4.91 + j0.36
1500	0.84 - j1.69	4.65 - j0.24
2000	0.88 - j3.05	2.8 - j1.05
2500	1.08 - j4.5	3.1 - j2.47
3000	1.25 - j6.06	3.1 - j4.01

Notes:

- ¹ $V_{DD} = 28\text{ V}$, $I_{DQ} = 2.0\text{ A}$ in the 440199 package
- ² Optimized for power, gain, P_{SAT} and PAE
- ³ When using this device at low frequency, series resistors should be used to maintain amplifier stability



CGH40180PP-AMP Demonstration Amplifier Circuit Schematic

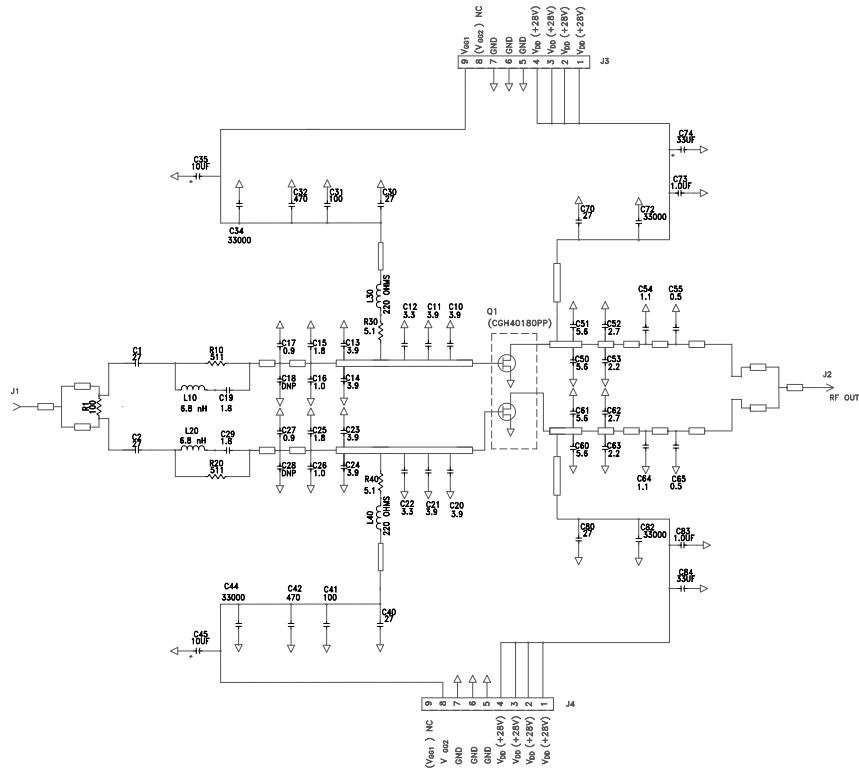

CGH40180PP-AMP Demonstration Amplifier Circuit Outline

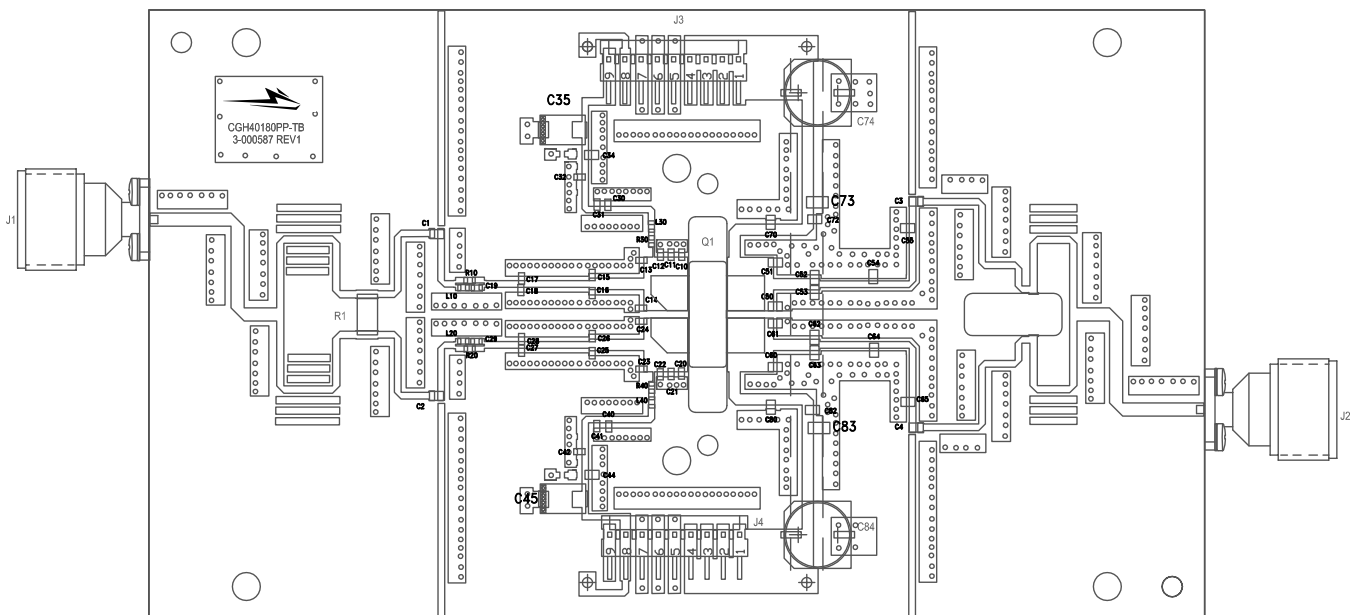



CGH40180PP-AMP Demonstration Amplifier Circuit Bill of Materials

Designator	Description	Qty
R1	RES, 100 Ohm, +/-1%, 1 W, 2512	1
R10, R20	RES, 511 Ohm, +/- 5%, 1/16W, 0603	2
R30, R40	RES, 1/16W, 0603, 1%, 5.1 OHMS	2
C1, C2, C3, C4, C30, C40, C70, C80	CAP, 27pF, +/-5% 0805, ATC600F	8
C10, C11, C13, C14, C20, C21, C23, C24	CAP, 3.9pF, +/-0.1 pF, 0603, ATC600S	8
C12, C22	CAP, 3.3pF, +/-0.1 pF, 0603, ATC600S	2
C15, C19, C25, C29	CAP, 3.3pF, +/-0.1 pF, 0603, ATC600S	4
C16, C26	CAP, 1.0pF, +/-0.1 pF, 0603, ATC600S	2
C17, C27	CAP, 0.9pF, +/-0.1 pF, 0603, ATC600S	2
C31, C41	CAP, 100pF, +/-5%, 0603, ATC600S	2
C32, C42	CAP, 470pF, 5%, 100V, 0603, X7R	2
C34, C44, C72, C82	CAP, 33000pF, 0805, 100V, X7R	4
C35, C45	CAP, 10uF, 16V, TANTALUM	2
C50, C51, C60, C61	CAP, 5.6pF, +/-0.1 pF, 0805, ATC600F	4
C52, C62	CAP, 2.7pF, +/-0.1 pF, 0805, ATC600F	2
C53, C63	CAP, 2.2pF, +/-0.1 pF, 0805, ATC600F	2
C54, C64	CAP, 1.1pF, +/-0.05 pF, 0805, ATC600F	2
C55, C65	CAP, 0.5pF, +/-0.05 pF, 0805, ATC600F	2
C73, C83	CAP, 1.0uF, +/-10%, 1210, 100V, X7R	2
C74, C84	CAP, 33uF, 100V, ELECT, FK, SMD	2
L10, L20	IND, 6.8nH, 0603, L-14C6N8ST	2
L30, L40	FERRITE, 220 OHM, 0603, BLM21PG221SN1	2
J1, J2	CONN, N-Type, Female, 0.500 SMA Flange	2
J3, J4	CONN, Header, RT> PLZ, 0.1 CEN, LK, 9 POS	2
—	PCB, RO4350, Er = 3.48, h = 20 mil	1
Q1	CGH40180PP	1

CGH40180PP-AMP Demonstration Amplifier Circuit

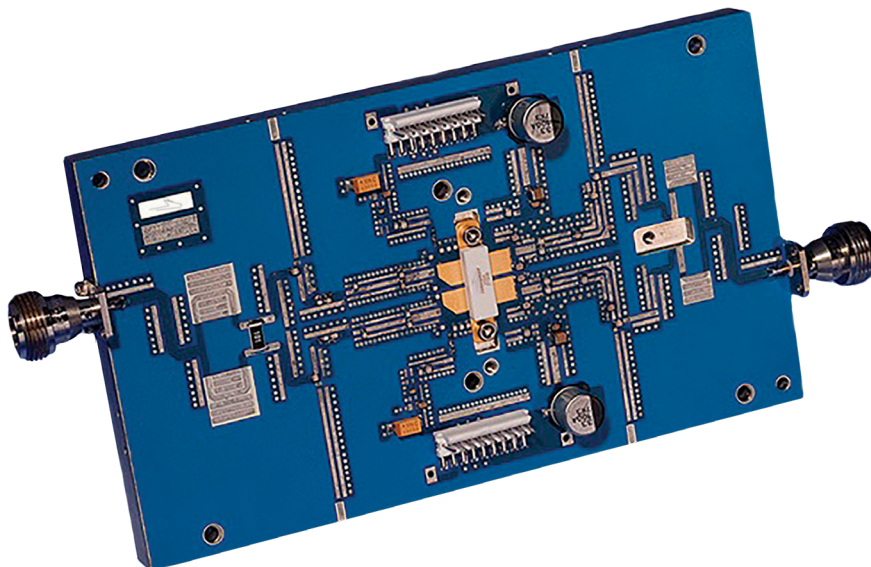



Typical Package S-Parameters for CGH40180PP, Single Side
(Small Signal, $V_{DS} = 28$ V, $I_{DQ} = 1000$ mA, angle in degrees)

Frequency	Mag S11	Ang S11	Mag S21	Ang S21	Mag S12	Ang S12	Mag S22	Ang S22
500 MHz	0.957	-177.48	4.22	79.26	0.007	10.74	0.798	-179.16
600 MHz	0.957	-178.74	3.51	76.30	0.007	12.14	0.800	-179.41
700 MHz	0.957	-179.78	3.00	73.47	0.007	13.71	0.802	-179.63
800 MHz	0.957	179.32	2.62	70.74	0.007	15.38	0.804	-179.84
900 MHz	0.957	178.51	2.33	68.08	0.007	17.15	0.807	179.96
1.0 GHz	0.957	177.76	2.09	65.49	0.007	18.99	0.809	179.74
1.1 GHz	0.957	177.06	1.90	62.95	0.007	20.87	0.812	179.52
1.2 GHz	0.957	176.38	1.73	60.46	0.007	22.80	0.814	179.28
1.3 GHz	0.957	175.72	1.60	58.02	0.008	24.73	0.817	179.03
1.4 GHz	0.956	175.08	1.48	55.63	0.008	26.66	0.820	178.76
1.5 GHz	0.956	174.44	1.38	53.29	0.008	28.57	0.823	178.46
1.6 GHz	0.956	173.81	1.29	50.98	0.008	30.44	0.825	178.15
1.7 GHz	0.956	173.18	1.22	48.72	0.008	32.25	0.828	177.82
1.8 GHz	0.955	172.55	1.15	46.50	0.009	33.98	0.831	177.47
1.9 GHz	0.955	171.91	1.09	44.32	0.009	35.62	0.833	177.10
2.0 GHz	0.955	171.27	1.04	42.17	0.009	37.17	0.835	176.71
2.1 GHz	0.954	170.62	0.99	40.06	0.010	38.61	0.838	176.30
2.2 GHz	0.954	169.96	0.95	37.98	0.010	39.93	0.840	175.87
2.3 GHz	0.953	169.29	0.91	35.93	0.011	41.14	0.842	175.42
2.4 GHz	0.952	168.60	0.87	33.91	0.011	42.22	0.844	174.95
2.5 GHz	0.952	167.90	0.84	31.92	0.012	43.18	0.845	174.47
2.6 GHz	0.951	167.18	0.82	29.95	0.013	44.01	0.847	173.96
2.7 GHz	0.950	166.45	0.79	28.00	0.013	44.73	0.848	173.44
2.8 GHz	0.949	165.69	0.77	26.07	0.014	45.32	0.849	172.89
2.9 GHz	0.948	164.91	0.75	24.15	0.015	45.79	0.850	172.33
3.0 GHz	0.946	164.10	0.73	22.24	0.016	46.15	0.850	171.74
3.2 GHz	0.943	162.39	0.71	18.45	0.018	46.53	0.851	170.51
3.4 GHz	0.939	160.55	0.69	14.64	0.020	46.47	0.850	169.19
3.6 GHz	0.935	158.53	0.67	10.80	0.023	45.97	0.848	167.76
3.8 GHz	0.929	156.31	0.67	6.86	0.027	45.03	0.845	166.21
4.0 GHz	0.922	153.83	0.67	2.78	0.031	43.63	0.841	164.53
4.2 GHz	0.913	151.03	0.68	-1.51	0.036	41.72	0.834	162.69
4.4 GHz	0.901	147.82	0.69	-6.12	0.042	39.23	0.825	160.65
4.6 GHz	0.886	144.10	0.72	-11.16	0.049	36.07	0.813	158.39
4.8 GHz	0.866	139.68	0.76	-16.81	0.059	32.05	0.797	155.86
5.0 GHz	0.838	134.36	0.81	-23.30	0.073	26.92	0.775	153.00
5.2 GHz	0.799	127.78	0.88	-30.99	0.091	20.30	0.747	149.76
5.4 GHz	0.742	119.49	0.97	-40.41	0.117	11.55	0.708	146.16
5.6 GHz	0.658	108.92	1.08	-52.33	0.157	-0.34	0.657	142.31
5.8 GHz	0.534	95.85	1.21	-67.76	0.219	-16.90	0.594	138.62
6.0 GHz	0.373	82.93	1.34	-87.69	0.321	-40.38	0.534	134.70

To download the s-parameters in s2p format, go to the [CGH40180PP Product page](#) and click on the documentation tab.



Product Dimensions CGH40180PP (Package Type — 440199)

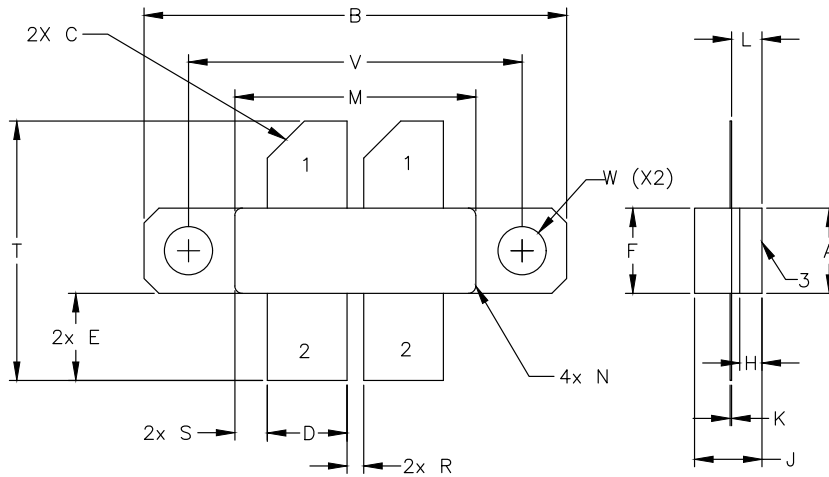

DIM	INCHES		MILLIMETERS	
	MIN	MAX	MIN	MAX
A	0.225	0.235	5.72	5.97
B	1.135	1.145	28.83	29.00
C	0.10	45° REF	2.54	45° REF
D	0.210	0.220	5.33	5.59
E	0.230	0.240	5.84	6.00
F	0.225	0.235	5.71	5.97
H	0.055	0.065	1.40	1.65
J	0.174	0.208	3.87	4.37
K	0.003	0.006	0.08	0.15
L	0.075	0.085	1.91	2.16
M	0.643	0.657	16.30	16.70
N	R.010 REF		R0.51 REF	
R	0.040	0.050	1.00	1.27
S	0.083	0.093	2.10	2.36
T	0.680	0.720	17.30	18.30
V	0.895	0.905	22.70	22.98
W	ø.130		ø 3.30	



Part Number System

CGH40180PP



Table 1.

Parameter	Value	Units
Upper Frequency ¹	2.5	GHz
Power Output	180	W
Package	Push Pill	—

Note:
¹ Alpha characters used in frequency code indicate a value greater than 9.9 GHz. See Table 2 for value.

Table 2.

Character Code	Code Value
A	0
B	1
C	2
D	3
E	4
F	5
G	6
H	7
J	8
K	9
Examples:	1A = 10.0 GHz 2H = 27.0 GHz

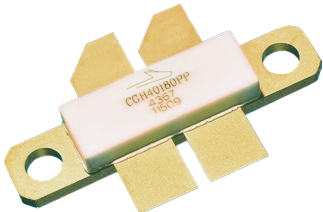
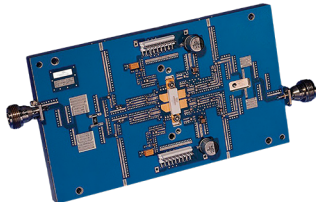

Product Ordering Information

Order Number	Description	Unit of Measure	Image
CGH40180PP	GaN HEMT	Each	 A photograph of a GaN HEMT component. It consists of a white rectangular chip mounted on a yellow metal carrier with two circular mounting holes on the sides. The chip has the text "CGH40180PP", "4.35", and "1550" printed on it.
CGH40180PP-AMP	Test board with GaN HEMT installed	Each	 A photograph of a blue printed circuit board (PCB) populated with various electronic components. A central component is the GaN HEMT chip, which is mounted on a small white carrier. The board includes connectors, resistors, and other surface components.

**For more information, please contact:**

4600 Silicon Drive
Durham, NC 27703 USA
Tel: +1.919.313.5300
www.wolfspeed.com/RF

Sales Contact
RFSales@wolfspeed.com

RF Product Marketing Contact
RFMarketing@wolfspeed.com

Notes & Disclaimer

Specifications are subject to change without notice. “Typical” parameters are the average values expected by Wolfspeed in large quantities and are provided for information purposes only. Wolfspeed products are not warranted or authorized for use as critical components in medical, life-saving, or life-sustaining applications, or other applications where a failure would reasonably be expected to cause severe personal injury or death. No responsibility is assumed by Wolfspeed for any infringement of patents or other rights of third parties which may result from use of the information contained herein. No license is granted by implication or otherwise under any patent or patent rights of Wolfspeed.

© 2015-2022 Wolfspeed, Inc. All rights reserved. Wolfspeed® and the Wolfstreak logo are registered trademarks and the Wolfspeed logo is a trademark of Wolfspeed, Inc.
PATENT: <https://www.wolfspeed.com/legal/patents>

The information in this document is subject to change without notice.