

NL17SG17

Schmitt Buffer

The NL17SG17 MiniGate™ is an advanced high-speed CMOS Schmitt Buffer in ultra-small footprint.

The NL17SG17 input structures provides protection when voltages up to 4.6 V are applied.

Features

- Wide Operating V_{CC} Range: 0.9 V to 3.6 V
- High Speed: $t_{PD} = 3.7$ ns (Typ) at $V_{CC} = 3.0$ V, $C_L = 15$ pF
- Low Power Dissipation: $I_{CC} = 0.5$ μ A (Max) at $T_A = 25^\circ$ C
- 4.6 V Overvoltage Tolerant (OVT) Input Pins
- Ultra-Small Packages
- These Devices are Pb-Free, Halogen Free/BFR Free and are RoHS Compliant

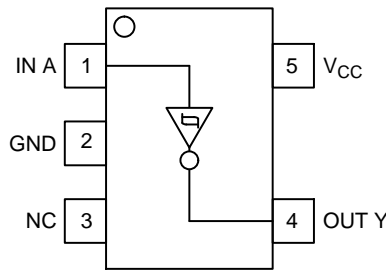

Figure 1. SOT-953 (Top Thru View)

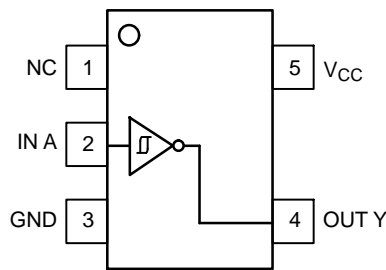

Figure 2. SC-88A (Top View)

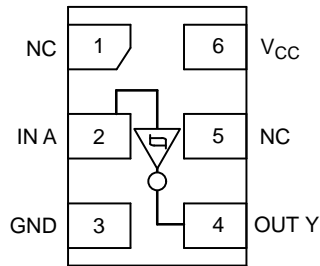

Figure 3. UDFN6 (Top View)

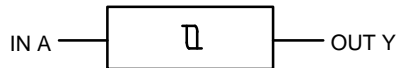

Figure 4. Logic Symbol



ON Semiconductor®

www.onsemi.com

MARKING DIAGRAMS



SOT-953
CASE 527AE

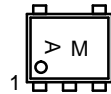

A = Specific Device Code
(A with 90 degree clockwise rotation)



UDFN6
1.0 x 1.0
CASE 517BX



UDFN6
1.45 x 1.0
CASE 517AQ

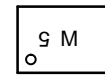

SC-88A
DF SUFFIX
CASE 419A

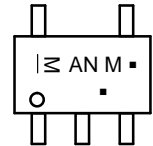

M = Date Code*
▪ = Pb-Free Package

(Note: Microdot may be in either location)

*Date Code orientation and/or position may vary depending upon manufacturing location.

PIN ASSIGNMENT			
	SOT-953	SC-88A	UDFN6
1	IN A	NC	NC
2	GND	IN A	IN A
3	NC	GND	GND
4	OUT Y	OUT Y	OUT Y
5	V_{CC}	V_{CC}	NC
6			V_{CC}

FUNCTION TABLE

A Input	Y Output
L	L
H	H

ORDERING INFORMATION

See detailed ordering and shipping information on page 5 of this data sheet.

NL17SG17

MAXIMUM RATINGS

Symbol	Parameter	Value	Unit
V_{CC}	DC Supply Voltage	-0.5 to +5.5	V
V_{IN}	DC Input Voltage	-0.5 to +4.6	V
V_{OUT}	DC Output Voltage Output at High or Low State Power-Down Mode ($V_{CC} = 0\text{ V}$)	-0.5 to $V_{CC} + 0.5$ -0.5 to +4.6	V
I_{IK}	DC Input Diode Current $V_{IN} < \text{GND}$	-20	mA
I_{OK}	DC Output Diode Current $V_{OUT} < \text{GND}$	-20	mA
I_{OUT}	DC Output Source/Sink Current	± 20	mA
I_{CC}	DC Supply Current per Supply Pin	± 20	mA
I_{GND}	DC Ground Current per Ground Pin	± 20	mA
T_{STG}	Storage Temperature Range	-65 to +150	$^{\circ}\text{C}$
T_L	Lead Temperature, 1 mm from Case for 10 Seconds	260	$^{\circ}\text{C}$
T_J	Junction Temperature Under Bias	+150	$^{\circ}\text{C}$
MSL	Moisture Sensitivity	Level 1	
F_R	Flammability Rating Oxygen Index: 28 to 34	UL 94 V-0 @ 0.125 in	
V_{ESD}	ESD Withstand Voltage Human Body Model (Note 2) Machine Model (Note 3)	>2000 >100	V

Stresses exceeding those listed in the Maximum Ratings table may damage the device. If any of these limits are exceeded, device functionality should not be assumed, damage may occur and reliability may be affected.

1. Measured with minimum pad spacing on an FR4 board, using 10 mm-by-1 inch, 2-ounce copper trace with no air flow.
2. Tested to EIA/JESD22-A114-A.
3. Tested to EIA/JESD22-A115-A.
4. Tested to EIA/JESD78.

RECOMMENDED OPERATING CONDITIONS

Symbol	Characteristics	Min	Max	Unit
V_{CC}	Positive DC Supply Voltage	0.9	3.6	V
V_{IN}	Digital Input Voltage	0.0	3.6	V
V_{OUT}	Output Voltage Output at High or Low State Power-Down Mode ($V_{CC} = 0\text{ V}$)	0.0 0.0	V_{CC} 3.6	V
T_A	Operating Temperature Range	-55	+125	$^{\circ}\text{C}$
$\Delta t / \Delta V$	Input Transition Rise or Fall Rate	0	No Limit	ns/V

Functional operation above the stresses listed in the Recommended Operating Ranges is not implied. Extended exposure to stresses beyond the Recommended Operating Ranges limits may affect device reliability.

NL17SG17

DC ELECTRICAL CHARACTERISTICS

Symbol	Parameter	Condition	V _{CC} (V)	T _A = 25°C			-55°C ≤ T _A ≤ 125°C		Unit
				Min	Typ	Max	Min	Max	
V _{T+}	Positive-Going Input Threshold Voltage		0.9	0.64	0.7	0.86	0.62	0.87	V
			1.1	0.73	0.81	0.95	0.71	1	
			1.4	0.86	0.94	1.16	0.84	1.2	
			1.65	0.95	1.06	1.25	0.94	1.3	
			2.3	1.22	1.36	1.6	1.18	1.65	
			3.0	1.51	1.8	2.05	1.38	2.1	
V _{T-}	Negative-Going Input Threshold Voltage		0.9	0.09	0.23	0.30	0.08	0.33	V
			1.1	0.15	0.33	0.39	0.12	0.43	
			1.4	0.3	0.47	0.54	0.25	0.55	
			1.65	0.35	0.6	0.65	0.3	0.65	
			2.3	0.55	0.85	0.88	0.5	0.88	
			3.0	0.95	1.13	1.16	0.9	1.16	
V _H	Hysteresis Voltage		0.9	0.15	0.5	0.75	0.2	0.8	V
			1.1	0.15	0.5	0.75	0.2	0.8	
			1.4	0.15	0.5	0.75	0.2	0.8	
			1.65	0.15	0.5	0.75	0.2	0.8	
			2.3	0.15	0.5	0.75	0.2	0.8	
			3.0	0.25	0.65	0.85	0.3	0.9	
V _{OH}	High-Level Output Voltage	V _{IN} = V _{IH} or V _{IL}	I _{OH} = -20 μA	0.9	0.75		0.75		V
			I _{OH} = -0.3 mA	1.1 to 1.3	0.75 x V _{CC}		0.75 x V _{CC}		
			I _{OH} = -1.7 mA	1.4 to 1.6	0.75 x V _{CC}		0.75 x V _{CC}		
			I _{OH} = -3.0 mA	1.65 to 1.95	V _{CC} - 0.45		V _{CC} - 0.45		
			I _{OH} = -4.0 mA	2.3 to 2.7	2.0		2.0		
			I _{OH} = -8.0 mA	3.0 to 3.6	2.48		2.48		
V _{OL}	Low-Level Output Voltage	V _{IN} = V _{IH} or V _{IL}	I _{OL} = 20 μA	0.9		0.1		0.1	V
			I _{OL} = 0.3 mA	1.1 to 1.3		0.25 x V _{CC}		0.25 x V _{CC}	
			I _{OL} = 1.7 mA	1.4 to 1.6		0.25xV _{CC}		0.25 x V _{CC}	
			I _{OL} = 3.0 mA	1.65 to 1.95		0.45		0.45	
			I _{OL} = 4.0 mA	2.3 to 2.7		0.4		0.4	
			I _{OL} = 8.0 mA	3.0 to 3.6		0.4		0.4	
I _{IN}	Input Leakage Current	0 ≤ V _{IN} ≤ 3.6 V	0 to 3.6			±0.1		±1.0	μA
I _{CC}	Quiescent Supply Current	V _{IN} = V _{CC} or GND	3.6			0.5		10.0	μA

Product parametric performance is indicated in the Electrical Characteristics for the listed test conditions, unless otherwise noted. Product performance may not be indicated by the Electrical Characteristics if operated under different conditions.

NL17SG17

AC ELECTRICAL CHARACTERISTICS (Input $t_r = t_f = 3.0$ ns)

Symbol	Parameter	Test Condition	V_{CC} (V)	$T_A = 25^\circ\text{C}$			$T_A = -55^\circ\text{C to } +125^\circ\text{C}$		Unit
				Min	Typ	Max	Min	Max	
t_{PLH} , t_{PHL}	Propagation Delay, A to Y	$C_L = 10$ pF, $R_L = 1$ M Ω	0.9	–	27.3	–	–	–	ns
			1.1 to 1.3	–	13.0	22.6	1.0	35.9	
			1.4 to 1.6	–	7.5	10.5	1.0	11.3	
			1.65 to 1.95	–	6.0	7.8	1.0	8.2	
			2.3 to 2.7	–	4.3	5.4	1.0	5.8	
			3.0 to 3.6	–	3.5	4.4	1.0	4.6	
		$C_L = 15$ pF, $R_L = 1$ M Ω	0.9	–	29.5	–	–	–	ns
			1.1 to 1.3	–	14.3	25.1	1.0	41.8	
			1.4 to 1.6	–	8.0	11.5	1.0	12.6	
			1.65 to 1.95	–	6.3	8.4	1.0	8.7	
			2.3 to 2.7	–	4.6	5.7	1.0	6.1	
			3.0 to 3.6	–	3.7	4.6	1.0	5.0	
		$C_L = 30$ pF, $R_L = 1$ M Ω	0.9	–	40.5	–	–	–	ns
			1.1 to 1.3	–	19.6	35.7	1.0	58.1	
			1.4 to 1.6	–	10.7	15.8	1.0	17.6	
			1.65 to 1.95	–	7.8	10.7	1.0	11.7	
			2.3 to 2.7	–	5.4	6.9	1.0	8.1	
			3.0 to 3.6	–	4.3	5.2	1.0	6.1	
C_{IN}	Input Capacitance		0 to 3.6		3	–	–	pF	
C_O	Output Capacitance	$V_O = \text{GND}$	0		3	–	–	pF	
C_{PD}	Power Dissipation Capacitance (Note 5)	$f = 10$ MHz	0.9 to 3.6	–	4	–	–	pF	

Product parametric performance is indicated in the Electrical Characteristics for the listed test conditions, unless otherwise noted. Product performance may not be indicated by the Electrical Characteristics if operated under different conditions.

5. C_{PD} is defined as the value of the internal equivalent capacitance which is calculated from the dynamic operating current consumption without load. Average operating current can be obtained by the equation: $I_{CC(OPR)} = C_{PD} \cdot V_{CC} \cdot f_{in} + I_{CC}$. C_{PD} is used to determine the no-load dynamic power consumption; $P_D = C_{PD} \cdot V_{CC}^2 \cdot f_{in} + I_{CC} \cdot V_{CC}$.

NL17SG17

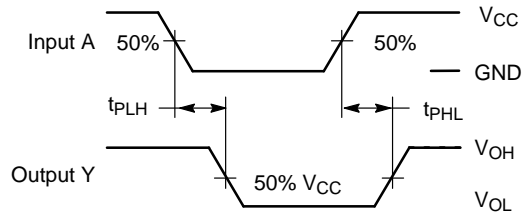
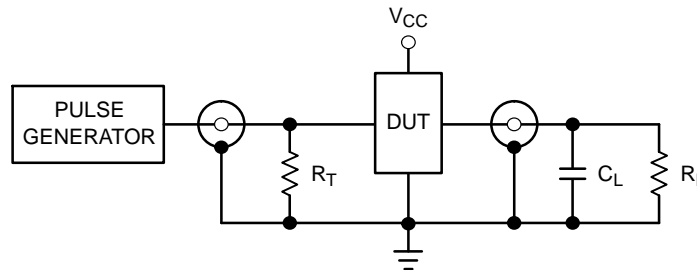

Figure 5. Switching Waveform



$R_T = Z_{OUT}$ of pulse generator (typically 50 Ω)

Figure 6. Test Circuit

ORDERING INFORMATION

Device	Package	Shipping [†]
NL17SG17P5T5G	SOT-953 (Pb-Free)	8000 / Tape & Reel
NL17SG17DFT2G	SC-88A (Pb-Free)	3000 / Tape & Reel
NL17SG17AMUTCG	UDFN6 1.45x1 mm (Pb-Free)	3000 / Tape & Reel
NL17SG17CMUTCG*	UDFN6 1x1 mm (Pb-Free)	3000 / Tape & Reel

[†]For information on tape and reel specifications, including part orientation and tape sizes, please refer to our Tape and Reel Packaging Specifications Brochure, BRD8011/D.

*In Development

MECHANICAL CASE OUTLINE PACKAGE DIMENSIONS



SCALE 2:1

SC-88A (SC-70-5/SOT-353) CASE 419A-02 ISSUE M

DATE 11 APR 2023

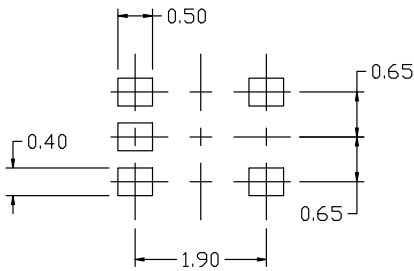
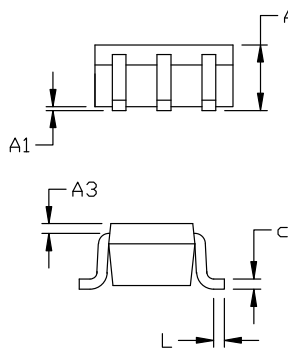
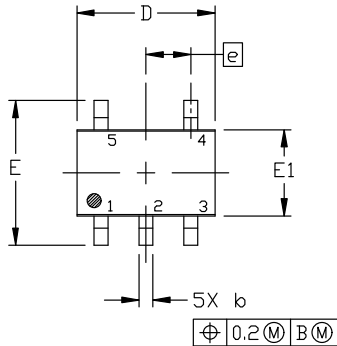

RECOMMENDED MOUNTING FOOTPRINT

* For additional information on our Pb-Free strategy and soldering details, please download the ON Semiconductor Soldering and Mounting Techniques Reference Manual, SOLDERM/D.

NOTES:

1. DIMENSIONING AND TOLERANCING PER ANSI Y14.5M, 1982.
2. CONTROLLING DIMENSION: MILLIMETERS
3. 419A-01 OBSOLETE. NEW STANDARD 419A-02
4. DIMENSIONS D AND E1 DO NOT INCLUDE MOLD FLASH, PROTRUSIONS, OR GATE BURRS. MOLD FLASH, PROTRUSIONS, OR GATE BURRS SHALL NOT EXCEED 0.1016MM PER SIDE.

DIM	MILLIMETERS		
	MIN.	NOM.	MAX.
A	0.80	0.95	1.10
A1	---	---	0.10
A3	0.20 REF		
b	0.10	0.20	0.30
c	0.10	---	0.25
D	1.80	2.00	2.20
E	2.00	2.10	2.20
E1	1.15	1.25	1.35
e	0.65 BSC		
L	0.10	0.15	0.30

GENERIC MARKING DIAGRAM*

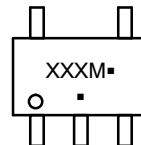

*This information is generic. Please refer to device data sheet for actual part marking. Pb-Free indicator, "G" or microdot "▪", may or may not be present. Some products may not follow the Generic Marking.

XXX = Specific Device Code

M = Date Code

▪ = Pb-Free Package

(Note: Microdot may be in either location)

STYLE 1:

1. BASE
2. EMITTER
3. BASE
4. COLLECTOR
5. COLLECTOR

STYLE 2:

1. ANODE
2. EMITTER
3. BASE
4. COLLECTOR
5. CATHODE

STYLE 3:

1. ANODE 1
2. N/C
3. ANODE 2
4. CATHODE 2
5. CATHODE 1

STYLE 4:

1. SOURCE 1
2. DRAIN 1/2
3. SOURCE 1
4. GATE 1
5. GATE 2

STYLE 5:

1. CATHODE
2. COMMON ANODE
3. CATHODE 2
4. CATHODE 3
5. CATHODE 4

STYLE 6:

1. EMITTER 2
2. BASE 2
3. EMITTER 1
4. COLLECTOR
5. COLLECTOR 2/BASE 1

STYLE 7:

1. BASE
2. EMITTER
3. BASE
4. COLLECTOR
5. COLLECTOR

STYLE 8:

1. CATHODE
2. COLLECTOR
3. N/C
4. BASE
5. EMITTER

STYLE 9:

1. ANODE
2. CATHODE
3. ANODE
4. ANODE
5. ANODE

Note: Please refer to datasheet for style callout. If style type is not called out in the datasheet refer to the device datasheet pinout or pin assignment.

DOCUMENT NUMBER:	98ASB42984B	Electronic versions are uncontrolled except when accessed directly from the Document Repository. Printed versions are uncontrolled except when stamped "CONTROLLED COPY" in red.
DESCRIPTION:	SC-88A (SC-70-5/SOT-353)	PAGE 1 OF 1

onsemi and ONSEMI are trademarks of Semiconductor Components Industries, LLC dba onsemi or its subsidiaries in the United States and/or other countries. onsemi reserves the right to make changes without further notice to any products herein. onsemi makes no warranty, representation or guarantee regarding the suitability of its products for any particular purpose, nor does onsemi assume any liability arising out of the application or use of any product or circuit, and specifically disclaims any and all liability, including without limitation special, consequential or incidental damages. onsemi does not convey any license under its patent rights nor the rights of others.

MECHANICAL CASE OUTLINE PACKAGE DIMENSIONS



SCALE 4:1

UDFN6, 1.45x1.0, 0.5P
CASE 517AQ
ISSUE O

DATE 15 MAY 2008

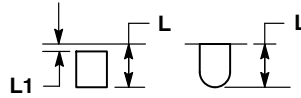
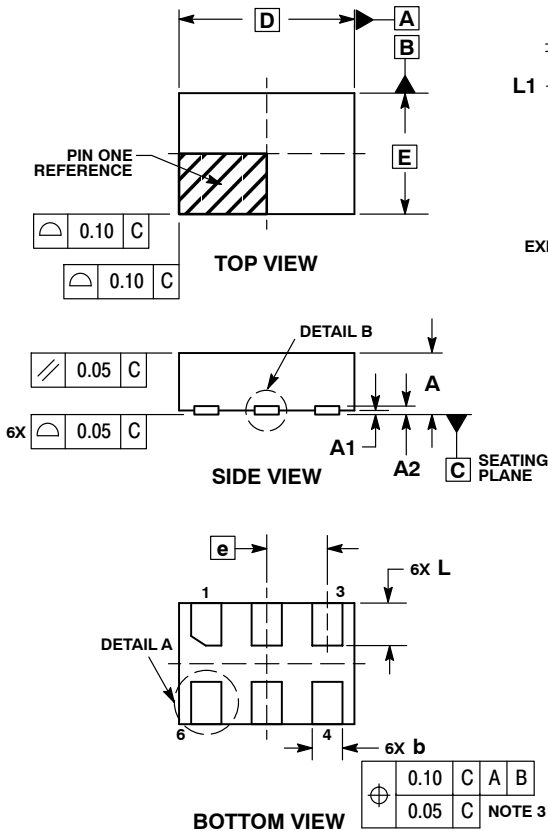

DETAIL A
OPTIONAL
CONSTRUCTIONS

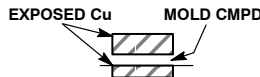

DETAIL B
OPTIONAL
CONSTRUCTIONS

NOTES:

1. DIMENSIONING AND TOLERANCING PER ASME Y14.5M, 1994.
2. CONTROLLING DIMENSION: MILLIMETERS.
3. DIMENSION b APPLIES TO PLATED TERMINAL AND IS MEASURED BETWEEN 0.15 AND 0.30 mm FROM THE TERMINAL TIP.

MILLIMETERS		
DIM	MIN	MAX
A	0.45	0.55
A1	0.00	0.05
A2	0.07	REF
b	0.20	0.30
D	1.45	BSC
E	1.00	BSC
e	0.50	BSC
L	0.30	0.40
L1	---	0.15

MOUNTING FOOTPRINT

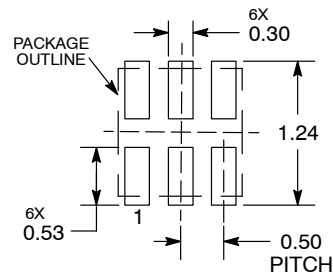

DIMENSIONS: MILLIMETERS

*For additional information on our Pb-Free strategy and soldering details, please download the ON Semiconductor Soldering and Mounting Techniques Reference Manual, SOLDERRM/D.

**GENERIC
MARKING DIAGRAM***



X = Specific Device Code
M = Date Code

*This information is generic. Please refer to device data sheet for actual part marking. Pb-Free indicator, "G" or microdot "▪", may or may not be present.

DOCUMENT NUMBER:	98AON30313E	Electronic versions are uncontrolled except when accessed directly from the Document Repository. Printed versions are uncontrolled except when stamped "CONTROLLED COPY" in red.
DESCRIPTION:	UDFN6, 1.45x1.0, 0.5P	PAGE 1 OF 1

onsemi and ONsemi are trademarks of Semiconductor Components Industries, LLC dba onsemi or its subsidiaries in the United States and/or other countries. onsemi reserves the right to make changes without further notice to any products herein. onsemi makes no warranty, representation or guarantee regarding the suitability of its products for any particular purpose, nor does onsemi assume any liability arising out of the application or use of any product or circuit, and specifically disclaims any and all liability, including without limitation special, consequential or incidental damages. onsemi does not convey any license under its patent rights nor the rights of others.

MECHANICAL CASE OUTLINE

PACKAGE DIMENSIONS

ON Semiconductor®



SCALE 4:1

SOT-953
CASE 527AE
ISSUE E

DATE 02 AUG 2011

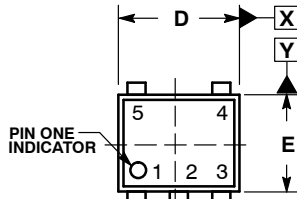

TOP VIEW

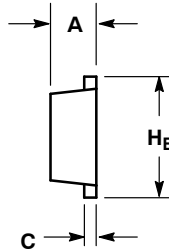

SIDE VIEW

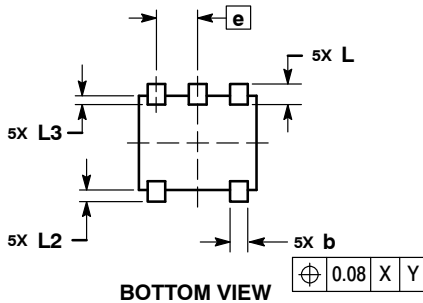

BOTTOM VIEW

SOLDERING FOOTPRINT*

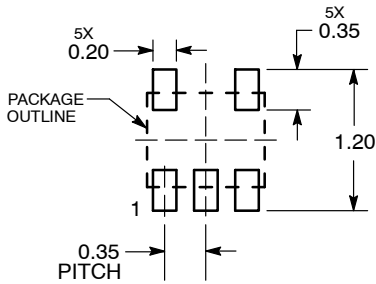

DIMENSIONS: MILLIMETERS

NOTES:

1. DIMENSIONING AND TOLERANCING PER ASME Y14.5M, 1994.
2. CONTROLLING DIMENSION: MILLIMETERS
3. MAXIMUM LEAD THICKNESS INCLUDES LEAD FINISH. MINIMUM LEAD THICKNESS IS THE MINIMUM THICKNESS OF THE BASE MATERIAL.
4. DIMENSIONS D AND E DO NOT INCLUDE MOLD FLASH, PROTRUSIONS, OR GATE BURRS.

DIM	MILLIMETERS		
	MIN	NOM	MAX
A	0.34	0.37	0.40
b	0.10	0.15	0.20
C	0.07	0.12	0.17
D	0.95	1.00	1.05
E	0.75	0.80	0.85
e	0.35 BSC		
H _E	0.95	1.00	1.05
L	0.175 REF		
L2	0.05	0.10	0.15
L3	---	---	0.15

GENERIC MARKING DIAGRAM*

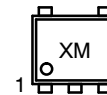

X = Specific Device Code
M = Month Code

*This information is generic. Please refer to device data sheet for actual part marking.
Pb-Free indicator, "G" or microdot "▪", may or may not be present.

*For additional information on our Pb-Free strategy and soldering details, please download the ON Semiconductor Soldering and Mounting Techniques Reference Manual, SOLDERRM/D.

DOCUMENT NUMBER:	98AON26457D	Electronic versions are uncontrolled except when accessed directly from the Document Repository. Printed versions are uncontrolled except when stamped "CONTROLLED COPY" in red.
DESCRIPTION:	SOT-953	PAGE 1 OF 1

ON Semiconductor and are trademarks of Semiconductor Components Industries, LLC dba ON Semiconductor or its subsidiaries in the United States and/or other countries. ON Semiconductor reserves the right to make changes without further notice to any products herein. ON Semiconductor makes no warranty, representation or guarantee regarding the suitability of its products for any particular purpose, nor does ON Semiconductor assume any liability arising out of the application or use of any product or circuit, and specifically disclaims any and all liability, including without limitation special, consequential or incidental damages. ON Semiconductor does not convey any license under its patent rights nor the rights of others.

onsemi, **Onsemi**, and other names, marks, and brands are registered and/or common law trademarks of Semiconductor Components Industries, LLC dba "**onsemi**" or its affiliates and/or subsidiaries in the United States and/or other countries. **onsemi** owns the rights to a number of patents, trademarks, copyrights, trade secrets, and other intellectual property. A listing of **onsemi**'s product/patent coverage may be accessed at www.onsemi.com/site/pdf/Patent-Marking.pdf. **onsemi** reserves the right to make changes at any time to any products or information herein, without notice. The information herein is provided "as-is" and **onsemi** makes no warranty, representation or guarantee regarding the accuracy of the information, product features, availability, functionality, or suitability of its products for any particular purpose, nor does **onsemi** assume any liability arising out of the application or use of any product or circuit, and specifically disclaims any and all liability, including without limitation special, consequential or incidental damages. Buyer is responsible for its products and applications using **onsemi** products, including compliance with all laws, regulations and safety requirements or standards, regardless of any support or applications information provided by **onsemi**. "Typical" parameters which may be provided in **onsemi** data sheets and/or specifications can and do vary in different applications and actual performance may vary over time. All operating parameters, including "Typicals" must be validated for each customer application by customer's technical experts. **onsemi** does not convey any license under any of its intellectual property rights nor the rights of others. **onsemi** products are not designed, intended, or authorized for use as a critical component in life support systems or any FDA Class 3 medical devices or medical devices with a same or similar classification in a foreign jurisdiction or any devices intended for implantation in the human body. Should Buyer purchase or use **onsemi** products for any such unintended or unauthorized application, Buyer shall indemnify and hold **onsemi** and its officers, employees, subsidiaries, affiliates, and distributors harmless against all claims, costs, damages, and expenses, and reasonable attorney fees arising out of, directly or indirectly, any claim of personal injury or death associated with such unintended or unauthorized use, even if such claim alleges that **onsemi** was negligent regarding the design or manufacture of the part. **onsemi** is an Equal Opportunity/Affirmative Action Employer. This literature is subject to all applicable copyright laws and is not for resale in any manner.

PUBLICATION ORDERING INFORMATION

LITERATURE FULFILLMENT:

Email Requests to: orderlit@onsemi.com

onsemi Website: www.onsemi.com

TECHNICAL SUPPORT

North American Technical Support:
Voice Mail: 1 800-282-9855 Toll Free USA/Canada
Phone: 011 421 33 790 2910

Europe, Middle East and Africa Technical Support:

Phone: 00421 33 790 2910

For additional information, please contact your local Sales Representative